

1.5SMCJ SERIES

SURFACE MOUNT TRANSIENT VOLTAGE SUPPRESSOR VOLTAGE – 5.0-170 Volts Peak Pulse Power-1500 Watts

FEATURES

- For surface mounted applications in order to optimize board space
- Low profile package
- Built-in strain relief
- Glass passivated junction
- Excellent clamping capability
- Low inductance
- Repetition Rate (duty cycle): 0.05%
- Fast response time: typically less than 1.0ps from 0 volts to BV min.
- Typical I_b less than $1\mu A$ above 10V
- High temperature soldering:
260°C/10 seconds at terminals
- Plastic package has Underwriters Laboratory Flammability Classification 94V-0

SMC/DO-214AB

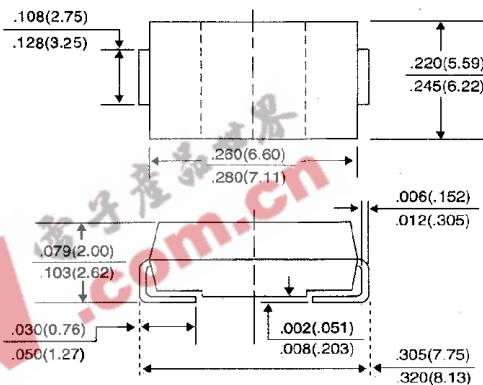

Dimensions in inches and (millimeters)

MECHANICAL DATA

Case: JEDEC DO-214AB molded plastic over passivated junction
 Terminals: Solder plated, solderable per MIL-STD-750, Method 2026
 Polarity: Color band denotes positive end (cathode) except bi-directional types
 Standard Packaging: 16mm tape (EIA-481)
 Weight: .007 ounces, 0.21 gram

MAXIMUM RATINGS AND ELECTRICAL CHARACTERISTICS

Ratings at 25°C ambient temperature unless otherwise specified.

| | SYMBOLS | VALUE | UNITS |
|--|----------------|--------------|-------|
| Peak Pulse Power Dissipation on 10/1000 μs waveform (Notes 1, 2, Fig. 1) | P_{PPM} | Minimum 1500 | Watts |
| Peak Pulse Current on 10/1000 μs waveform (Note 1, Fig. 3) | I_{PPM} | See Table 1 | Amps |
| Peak forward Surge Current 8.3ms single half sine-wave superimposed on rated load (JEDEC Method) (NOTES 2,3) | I_{FSM} | 100.0 | Amps |
| Operating Junction and Storage Temperature Range | T_J, T_{STG} | -55 to +150 | °C |

NOTES:

1. Non-repetitive current pulse, per Fig.3 and derated above $T_A = 25^\circ C$ per Fig. 2.
2. Mounted on 8.0mm² copper pads to each terminal.
3. 8.3ms single half sine-wave, or equivalent square wave, duty cycle = 4 pulses per minutes maximum.

RATING AND CHARACTERISTIC CURVES 1.5SMCJ SERIES

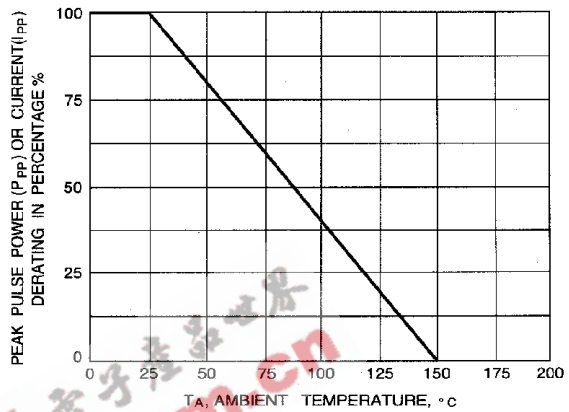

FIG. 2-PULSE RATING CURVE



FIG. 3-PULSE WAVEFORM



FIG. 4-TYPICAL JUNCTION CAPACITANCE



FIG. 5-MAXIMUM NON-REPETITIVE PEAK FORWARD SURGE CURRENT



UNI-DIRECTIONAL 1500 Watt Surface Mount TVS

| UNI-DIRECTIONAL PART NUMBER | DEVICE MARKING CODE | REVERSE STAND-OFF VOLTAGE VRWM (V) | BREAKDOWN VOLTAGE VBR (V) MIN. @ IT | BREAKDOWN VOLTAGE VBR (V) MAX. @ IT | TEST CURRENT IT (mA) | MAXIMUM CLAMPING VOLTAGE @Ipp Vc (V) | PEAK PULSE CURRENT Ipp (A) | REVERSE LEAKAGE @VRWM IR (uA) |
|-----------------------------|---------------------|------------------------------------|-------------------------------------|-------------------------------------|----------------------|--------------------------------------|----------------------------|-------------------------------|
| 1.5SMCJ5.0 | GDD | 5.0 | 6.40 | 7.55 | 10 | 9.6 | 156.2 | 1000 |
| 1.5SMCJ5.0A | GDE | 5.0 | 6.40 | 7.25 | 10 | 9.2 | 163.0 | 1000 |
| 1.5SMCJ6.0 | GDF | 6.0 | 6.67 | 8.45 | 10 | 11.4 | 131.6 | 1000 |
| 1.5SMCJ6.0A | GDG | 6.0 | 6.67 | 7.67 | 10 | 10.3 | 145.6 | 1000 |
| 1.5SMCJ6.5 | GDH | 6.5 | 7.22 | 9.14 | 10 | 12.3 | 122.0 | 500 |
| 1.5SMCJ6.5A | GDK | 6.5 | 7.22 | 8.30 | 10 | 11.2 | 133.9 | 500 |
| 1.5SMCJ7.0 | CDL | 7.0 | 7.78 | 9.86 | 10 | 13.3 | 112.8 | 200 |
| 1.5SMCJ7.0A | GDM | 7.0 | 7.78 | 8.95 | 10 | 12.0 | 125.0 | 200 |
| 1.5SMCJ7.5 | GDN | 7.5 | 8.33 | 10.67 | 1 | 14.3 | 104.9 | 100 |
| 1.5SMCJ7.5A | GDP | 7.5 | 8.33 | 9.58 | 1 | 12.9 | 116.3 | 100 |
| 1.5SMCJ8.0 | GDO | 8.0 | 8.89 | 11.30 | 1 | 15.0 | 100.0 | 50 |
| 1.5SMCJ8.0A | GDR | 8.0 | 8.89 | 10.23 | 1 | 13.6 | 110.3 | 50 |
| 1.5SMCJ8.5 | GDS | 8.5 | 9.44 | 11.92 | 1 | 15.9 | 94.3 | 25 |
| 1.5SMCJ8.5A | GDT | 8.5 | 9.44 | 10.82 | 1 | 14.4 | 104.2 | 20 |
| 1.5SMCJ9.0 | GDU | 9.0 | 10.00 | 12.60 | 1 | 16.9 | 88.7 | 10 |
| 1.5SMCJ9.0A | GDV | 9.0 | 10.00 | 11.50 | 1 | 15.4 | 97.4 | 10 |
| 1.5SMCJ10 | GDW | 10.0 | 11.10 | 14.10 | 1 | 18.8 | 79.8 | 5 |
| 1.5SMCJ10A | GDX | 10.0 | 11.10 | 12.80 | 1 | 17.0 | 88.2 | 5 |
| 1.5SMCJ11 | GDY | 11.0 | 12.20 | 15.40 | 1 | 20.1 | 74.6 | 5 |
| 1.5SMCJ11A | GDZ | 11.0 | 12.20 | 14.00 | 1 | 18.2 | 82.4 | 5 |
| 1.5SMCJ12 | GED | 12.0 | 13.30 | 16.90 | 1 | 22.0 | 68.2 | 5 |
| 1.5SMCJ12A | GEE | 12.0 | 13.30 | 15.30 | 1 | 19.9 | 75.3 | 5 |
| 1.5SMCJ13 | GEF | 13.0 | 14.40 | 18.20 | 1 | 23.8 | 63.0 | 5 |
| 1.5SMCJ13A | GEG | 13.0 | 14.40 | 16.50 | 1 | 21.5 | 69.7 | 5 |
| 1.5SMCJ14 | GEH | 14.0 | 15.60 | 19.80 | 1 | 25.8 | 58.7 | 5 |
| 1.5SMCJ14A | GEK | 14.0 | 15.60 | 17.90 | 1 | 23.2 | 64.7 | 5 |
| 1.5SMCJ15 | GEL | 15.0 | 16.70 | 21.10 | 1 | 29.9 | 55.8 | 5 |
| 1.5SMCJ15A | GEM | 15.0 | 16.70 | 19.20 | 1 | 24.4 | 61.5 | 5 |
| 1.5SMCJ16 | GEN | 16.0 | 17.80 | 22.60 | 1 | 28.4 | 52.1 | 5 |
| 1.5SMCJ16A | GEP | 16.0 | 17.80 | 20.50 | 1 | 26.0 | 57.7 | 5 |
| 1.5SMCJ17 | GEQ | 17.0 | 18.90 | 23.90 | 1 | 30.5 | 49.2 | 5 |
| 1.5SMCJ17A | GER | 17.0 | 18.90 | 21.70 | 1 | 27.6 | 53.3 | 5 |
| 1.5SMCJ18 | GES | 18.0 | 20.00 | 25.30 | 1 | 32.2 | 46.6 | 5 |
| 1.5SMCJ18A | GET | 18.0 | 20.00 | 23.30 | 1 | 29.2 | 51.4 | 5 |
| 1.5SMCJ20 | GEU | 20.0 | 22.20 | 28.10 | 1 | 35.8 | 41.9 | 5 |
| 1.5SMCJ20A | GEV | 20.0 | 22.20 | 25.50 | 1 | 32.4 | 46.3 | 5 |
| 1.5SMCJ22 | GEW | 22.0 | 24.40 | 30.90 | 1 | 39.4 | 38.1 | 5 |
| 1.5SMCJ22A | GEX | 22.0 | 24.40 | 28.00 | 1 | 35.5 | 42.2 | 5 |
| 1.5SMCJ24 | GEY | 24.0 | 26.70 | 33.80 | 1 | 43.0 | 34.9 | 5 |
| 1.5SMCJ24A | GEZ | 24.0 | 26.70 | 30.70 | 1 | 38.9 | 38.8 | 5 |
| 1.5SMCJ26 | GFD | 26.0 | 28.90 | 36.60 | 1 | 46.6 | 32.2 | 5 |
| 1.5SMCJ26A | GFE | 26.0 | 28.90 | 33.20 | 1 | 42.1 | 35.6 | 5 |
| 1.5SMCJ28 | GFF | 28.0 | 31.10 | 39.40 | 1 | 50.0 | 30.0 | 5 |
| 1.5SMCJ28A | GFG | 28.0 | 31.10 | 35.80 | 1 | 45.4 | 33.0 | 5 |
| 1.5SMCJ30 | GFH | 30.0 | 33.30 | 42.20 | 1 | 53.5 | 28.0 | 5 |
| 1.5SMCJ30A | GFK | 30.0 | 33.30 | 38.30 | 1 | 48.4 | 31.0 | 5 |
| 1.5SMCJ33 | GFL | 33.0 | 36.70 | 46.50 | 1 | 59.0 | 25.2 | 5 |
| 1.5SMCJ33A | GFM | 33.0 | 36.70 | 42.20 | 1 | 53.3 | 28.1 | 5 |
| 1.5SMCJ36 | GFN | 36.0 | 40.00 | 50.70 | 1 | 64.3 | 23.3 | 5 |
| 1.5SMCJ36A | GFP | 36.0 | 40.00 | 46.00 | 1 | 58.1 | 25.8 | 5 |
| 1.5SMCJ40 | GFQ | 40.0 | 44.40 | 56.30 | 1 | 71.4 | 21.0 | 5 |
| 1.5SMCJ40A | GFR | 40.0 | 44.40 | 51.10 | 1 | 64.5 | 23.2 | 5 |
| 1.5SMCJ43 | GFS | 43.0 | 47.80 | 60.50 | 1 | 76.7 | 19.6 | 5 |
| 1.5SMCJ43A | GFT | 43.0 | 47.80 | 54.90 | 1 | 69.4 | 21.6 | 5 |
| 1.5SMCJ45 | GFU | 45.0 | 50.00 | 63.30 | 1 | 80.3 | 18.7 | 5 |
| 1.5SMCJ45A | GFV | 45.0 | 50.00 | 57.50 | 1 | 72.7 | 20.6 | 5 |
| 1.5SMCJ48 | GFW | 48.0 | 53.30 | 67.50 | 1 | 85.5 | 17.6 | 5 |
| 1.5SMCJ48A | GFX | 48.0 | 53.30 | 61.30 | 1 | 77.4 | 19.4 | 5 |
| 1.5SMCJ51 | GFY | 51.0 | 56.70 | 71.80 | 1 | 91.1 | 15.6 | 5 |
| 1.5SMCJ51A | GFZ | 51.0 | 56.70 | 65.20 | 1 | 82.4 | 18.2 | 5 |
| 1.5SMCJ54 | GGD | 54.0 | 60.00 | 76.00 | 1 | 96.3 | 15.6 | 5 |
| 1.5SMCJ54A | GGE | 54.0 | 60.00 | 69.00 | 1 | 87.1 | 17.2 | 5 |
| 1.5SMCJ58 | GGF | 58.0 | 64.40 | 81.60 | 1 | 103.0 | 14.6 | 5 |
| 1.5SMCJ58A | GGG | 58.0 | 64.40 | 74.10 | 1 | 93.6 | 16.0 | 5 |
| 1.5SMCJ60 | GGH | 60.0 | 66.70 | 84.50 | 1 | 107.0 | 14.0 | 5 |
| 1.5SMCJ60A | GGK | 60.0 | 66.70 | 76.70 | 1 | 96.8 | 15.5 | 5 |
| 1.5SMCJ64 | GGL | 64.0 | 71.10 | 90.10 | 1 | 114.0 | 13.2 | 5 |
| 1.5SMCJ64A | GGM | 64.0 | 71.10 | 81.80 | 1 | 103.0 | 14.6 | 5 |
| 1.5SMCJ70 | GGN | 70.0 | 77.80 | 98.60 | 1 | 125.0 | 12.0 | 5 |
| 1.5SMCJ70A | GGP | 70.0 | 77.80 | 89.50 | 1 | 115.0 | 13.3 | 5 |
| 1.5SMCJ75 | GGQ | 75.0 | 83.30 | 105.70 | 1 | 134.0 | 11.2 | 5 |
| 1.5SMCJ75A | GGR | 75.0 | 83.30 | 95.80 | 1 | 121.0 | 12.4 | 5 |
| 1.5SMCJ78 | GGS | 78.0 | 86.70 | 109.80 | 1 | 139.0 | 10.8 | 5 |
| 1.5SMCJ78A | GGT | 78.0 | 86.70 | 99.70 | 1 | 126.0 | 11.4 | 5 |
| 1.5SMCJ85 | GGU | 85.0 | 94.40 | 119.20 | 1 | 151.0 | 9.9 | 5 |
| 1.5SMCJ85A | GGV | 85.0 | 94.40 | 108.20 | 1 | 137.0 | 10.4 | 5 |
| 1.5SMCJ90 | GGW | 90.0 | 100.00 | 126.50 | 1 | 160.0 | 9.4 | 5 |
| 1.5SMCJ90A | GGX | 90.0 | 100.00 | 115.50 | 1 | 146.0 | 10.3 | 5 |
| 1.5SMCJ100 | GGY | 100.0 | 111.00 | 141.00 | 1 | 179.0 | 8.4 | 5 |
| 1.5SMCJ100A | GGZ | 100.0 | 111.00 | 128.00 | 1 | 162.0 | 9.3 | 5 |
| 1.5SMCJ110 | GHD | 110.0 | 122.00 | 154.50 | 1 | 196.0 | 7.7 | 5 |
| 1.5SMCJ110A | GHE | 110.0 | 122.00 | 140.50 | 1 | 177.0 | 8.4 | 5 |
| 1.5SMCJ120 | GHF | 120.0 | 133.00 | 169.00 | 1 | 214.0 | 7.0 | 5 |
| 1.5SMCJ120A | GHG | 120.0 | 133.00 | 153.00 | 1 | 193.0 | 7.9 | 5 |
| 1.5SMCJ130 | GHH | 130.0 | 144.00 | 182.50 | 1 | 231.0 | 6.5 | 5 |
| 1.5SMCJ130A | GHK | 130.0 | 144.00 | 165.50 | 1 | 209.0 | 7.2 | 5 |
| 1.5SMCJ150 | GHL | 150.0 | 167.00 | 211.50 | 1 | 268.0 | 5.6 | 5 |
| 1.5SMCJ150A | GHM | 150.0 | 167.00 | 192.50 | 1 | 243.0 | 6.2 | 5 |
| 1.5SMCJ160 | GHN | 160.0 | 178.00 | 226.00 | 1 | 287.0 | 5.2 | 5 |
| 1.5SMCJ160A | GHP | 160.0 | 178.00 | 205.00 | 1 | 269.0 | 5.8 | 5 |
| 1.5SMCJ170 | GHQ | 170.0 | 189.00 | 239.50 | 1 | 304.0 | 4.9 | 5 |
| 1.5SMCJ170A | GHR | 170.0 | 189.00 | 217.50 | 1 | 275.0 | 5.5 | 5 |



BI-DIRECTIONAL 1500 Watt Surface Mount TVS

| BI-DIRECTIONAL PART NUMBER | DEVICE MARKING CODE | REVERSE STAND-OFF VOLTAGE VRWM (V) | BREAKDOWN VOLTAGE VBR (V) MIN. @ IT | BREAKDOWN VOLTAGE VBR (V) MAX. @ IT | TEST CURRENT IT (mA) | MAXIMUM CLAMPING VOLTAGE @Ipp Vc (V) | PEAK PULSE CURRENT Ipp (A) | REVERSE LEAKAGE @VRWM IR (uA) |
|----------------------------|---------------------|------------------------------------|-------------------------------------|-------------------------------------|----------------------|--------------------------------------|----------------------------|-------------------------------|
| 1.5SMCJ5.0C | BDD | 5.0 | 6.40 | 7.55 | 10 | 9.6 | 156.2 | 2000 |
| 1.5SMCJ5.0CA | BDE | 5.0 | 6.40 | 7.25 | 10 | 9.2 | 163.0 | 2000 |
| 1.5SMCJ6.0C | BDF | 6.0 | 6.67 | 8.45 | 10 | 11.4 | 131.6 | 2000 |
| 1.5SMCJ6.0CA | BDG | 6.0 | 6.67 | 7.67 | 10 | 10.3 | 145.6 | 2000 |
| 1.5SMCJ6.5C | BDH | 6.5 | 7.22 | 9.14 | 10 | 12.3 | 122.0 | 1000 |
| 1.5SMCJ6.5CA | BDK | 6.5 | 7.22 | 8.30 | 10 | 11.2 | 133.9 | 1000 |
| 1.5SMCJ7.0C | BDL | 7.0 | 7.78 | 9.86 | 10 | 13.3 | 112.8 | 400 |
| 1.5SMCJ7.0CA | BDM | 7.0 | 7.78 | 8.95 | 10 | 12.0 | 125.0 | 400 |
| 1.5SMCJ7.5C | BDN | 7.5 | 8.33 | 10.67 | 1 | 14.3 | 104.9 | 200 |
| 1.5SMCJ7.5CA | BDP | 7.5 | 8.33 | 9.58 | 1 | 12.9 | 116.3 | 200 |
| 1.5SMCJ8.0C | BDQ | 8.0 | 8.89 | 11.30 | 1 | 15.0 | 100.0 | 100 |
| 1.5SMCJ8.0CA | BDR | 8.0 | 8.89 | 10.23 | 1 | 13.6 | 110.3 | 100 |
| 1.5SMCJ8.5C | BDS | 8.5 | 9.44 | 11.92 | 1 | 15.9 | 94.3 | 50 |
| 1.5SMCJ8.5CA | BDT | 8.5 | 9.44 | 10.82 | 1 | 14.4 | 104.2 | 50 |
| 1.5SMCJ9.0C | BDU | 9.0 | 10.00 | 12.60 | 1 | 16.9 | 88.7 | 20 |
| 1.5SMCJ9.0CA | BDV | 9.0 | 10.00 | 11.50 | 1 | 15.4 | 97.4 | 20 |
| 1.5SMCJ10C | BDW | 10.0 | 11.10 | 14.10 | 1 | 18.8 | 79.8 | 5 |
| 1.5SMCJ10CA | BDX | 10.0 | 11.10 | 12.80 | 1 | 17.0 | 88.2 | 5 |
| 1.5SMCJ11C | BDY | 11.0 | 12.20 | 15.40 | 1 | 20.1 | 74.6 | 5 |
| 1.5SMCJ11CA | BDZ | 11.0 | 12.20 | 14.00 | 1 | 18.2 | 82.4 | 5 |
| 1.5SMCJ12C | BED | 12.0 | 13.30 | 16.90 | 1 | 22.0 | 66.2 | 5 |
| 1.5SMCJ12CA | BEE | 12.0 | 13.30 | 15.30 | 1 | 19.9 | 75.3 | 5 |
| 1.5SMCJ13C | BEF | 13.0 | 14.40 | 18.20 | 1 | 23.8 | 63.0 | 5 |
| 1.5SMCJ13CA | BEG | 13.0 | 14.40 | 16.50 | 1 | 21.5 | 69.7 | 5 |
| 1.5SMCJ14C | BEH | 14.0 | 15.60 | 19.80 | 1 | 25.8 | 58.1 | 5 |
| 1.5SMCJ14CA | BEK | 14.0 | 15.60 | 17.90 | 1 | 23.2 | 64.7 | 5 |
| 1.5SMCJ15C | BEL | 15.0 | 16.70 | 21.10 | 1 | 26.9 | 55.8 | 5 |
| 1.5SMCJ15CA | BEM | 15.0 | 16.70 | 19.20 | 1 | 24.4 | 61.5 | 5 |
| 1.5SMCJ16C | BEN | 16.0 | 17.80 | 22.60 | 1 | 28.8 | 52.1 | 5 |
| 1.5SMCJ16CA | BEP | 16.0 | 17.80 | 20.50 | 1 | 26.0 | 57.7 | 5 |
| 1.5SMCJ17C | BEQ | 17.0 | 18.90 | 23.90 | 1 | 30.5 | 49.2 | 5 |
| 1.5SMCJ17CA | BER | 17.0 | 18.90 | 21.70 | 1 | 27.6 | 53.3 | 5 |
| 1.5SMCJ18C | BES | 18.0 | 20.00 | 25.30 | 1 | 32.2 | 46.6 | 5 |
| 1.5SMCJ18CA | BET | 18.0 | 20.00 | 23.30 | 1 | 29.2 | 51.4 | 5 |
| 1.5SMCJ20C | BEU | 20.0 | 22.20 | 28.10 | 1 | 35.8 | 41.9 | 5 |
| 1.5SMCJ20CA | BEV | 20.0 | 22.20 | 25.50 | 1 | 32.4 | 46.3 | 5 |
| 1.5SMCJ22C | BEW | 22.0 | 24.40 | 30.90 | 1 | 39.4 | 38.1 | 5 |
| 1.5SMCJ22CA | BFX | 22.0 | 24.40 | 28.00 | 1 | 35.5 | 42.2 | 5 |
| 1.5SMCJ24C | BEY | 24.0 | 26.70 | 33.80 | 1 | 43.0 | 34.9 | 5 |
| 1.5SMCJ24CA | BEZ | 24.0 | 26.70 | 30.70 | 1 | 38.9 | 38.6 | 5 |
| 1.5SMCJ26C | BFD | 26.0 | 28.90 | 36.60 | 1 | 46.6 | 32.2 | 5 |
| 1.5SMCJ26CA | BFE | 26.0 | 28.90 | 33.20 | 1 | 42.1 | 35.6 | 5 |
| 1.5SMCJ28C | BFF | 28.0 | 31.10 | 39.40 | 1 | 50.0 | 30.0 | 5 |
| 1.5SMCJ28CA | BFG | 28.0 | 31.10 | 35.80 | 1 | 45.4 | 33.0 | 5 |
| 1.5SMCJ30C | BFH | 30.0 | 33.30 | 42.20 | 1 | 53.5 | 28.0 | 5 |
| 1.5SMCJ30CA | BFK | 30.0 | 33.30 | 38.30 | 1 | 48.4 | 31.0 | 5 |
| 1.5SMCJ33C | BFL | 33.0 | 36.70 | 46.50 | 1 | 59.0 | 25.2 | 5 |
| 1.5SMCJ33CA | BFM | 33.0 | 36.70 | 42.20 | 1 | 53.3 | 28.1 | 5 |
| 1.5SMCJ36C | BFN | 36.0 | 40.00 | 50.70 | 1 | 64.3 | 23.3 | 5 |
| 1.5SMCJ36CA | BFP | 36.0 | 40.00 | 46.00 | 1 | 58.1 | 25.8 | 5 |
| 1.5SMCJ40C | BFQ | 40.0 | 44.40 | 56.30 | 1 | 71.4 | 21.0 | 5 |
| 1.5SMCJ40CA | BFR | 40.0 | 44.40 | 51.10 | 1 | 64.5 | 23.2 | 5 |
| 1.5SMCJ43C | BFS | 43.0 | 47.80 | 60.50 | 1 | 76.7 | 19.6 | 5 |
| 1.5SMCJ43CA | BFT | 43.0 | 47.80 | 54.90 | 1 | 69.4 | 21.6 | 5 |
| 1.5SMCJ45C | BFU | 45.0 | 50.00 | 63.30 | 1 | 80.3 | 18.7 | 5 |
| 1.5SMCJ45CA | BFV | 45.0 | 50.00 | 57.50 | 1 | 72.7 | 20.6 | 5 |
| 1.5SMCJ48C | BFW | 48.0 | 53.30 | 67.50 | 1 | 85.5 | 17.5 | 5 |
| 1.5SMCJ48CA | BFX | 48.0 | 53.30 | 61.30 | 1 | 77.4 | 19.4 | 5 |
| 1.5SMCJ51C | BFY | 51.0 | 56.70 | 71.80 | 1 | 91.1 | 18.5 | 5 |
| 1.5SMCJ51CA | BFZ | 51.0 | 56.70 | 65.20 | 1 | 82.4 | 18.2 | 5 |
| 1.5SMCJ54C | BGD | 54.0 | 60.00 | 76.00 | 1 | 96.3 | 15.6 | 5 |
| 1.5SMCJ54CA | BGE | 54.0 | 60.00 | 69.00 | 1 | 87.1 | 17.2 | 5 |
| 1.5SMCJ58C | BGF | 58.0 | 64.40 | 81.60 | 1 | 103.0 | 14.6 | 5 |
| 1.5SMCJ58CA | BGG | 58.0 | 64.40 | 74.10 | 1 | 93.6 | 16.0 | 5 |
| 1.5SMCJ60C | BGH | 60.0 | 66.70 | 84.50 | 1 | 107.0 | 14.0 | 5 |
| 1.5SMCJ60CA | BGK | 60.0 | 66.70 | 76.70 | 1 | 96.8 | 15.5 | 5 |
| 1.5SMCJ64C | BGL | 64.0 | 71.10 | 90.10 | 1 | 114.0 | 13.2 | 5 |
| 1.5SMCJ64CA | BGM | 64.0 | 71.10 | 81.80 | 1 | 103.0 | 14.6 | 5 |
| 1.5SMCJ70C | BGN | 70.0 | 77.80 | 98.60 | 1 | 125.0 | 12.0 | 5 |
| 1.5SMCJ70CA | BGP | 70.0 | 77.80 | 89.50 | 1 | 113.0 | 13.3 | 5 |
| 1.5SMCJ75C | BGQ | 75.0 | 83.30 | 105.70 | 1 | 134.0 | 11.2 | 5 |
| 1.5SMCJ75CA | BGR | 75.0 | 83.30 | 95.80 | 1 | 121.0 | 12.4 | 5 |
| 1.5SMCJ78C | BGS | 78.0 | 86.70 | 109.80 | 1 | 139.0 | 10.8 | 5 |
| 1.5SMCJ78CA | BGT | 78.0 | 86.70 | 99.70 | 1 | 126.0 | 11.4 | 5 |
| 1.5SMCJ85C | BGU | 85.0 | 94.40 | 119.20 | 1 | 151.0 | 9.9 | 5 |
| 1.5SMCJ85CA | BGV | 85.0 | 94.40 | 108.20 | 1 | 137.0 | 10.4 | 5 |
| 1.5SMCJ90C | BGW | 90.0 | 100.00 | 126.50 | 1 | 160.0 | 9.4 | 5 |
| 1.5SMCJ90CA | BGX | 90.0 | 100.00 | 115.50 | 1 | 146.0 | 10.3 | 5 |
| 1.5SMCJ100C | BGY | 100.0 | 111.00 | 141.00 | 1 | 179.0 | 8.4 | 5 |
| 1.5SMCJ100CA | BGZ | 100.0 | 111.00 | 128.00 | 1 | 162.0 | 9.3 | 5 |
| 1.5SMCJ110C | BHD | 110.0 | 122.00 | 154.50 | 1 | 196.0 | 7.7 | 5 |
| 1.5SMCJ110CA | BHE | 110.0 | 122.00 | 140.50 | 1 | 177.0 | 8.4 | 5 |
| 1.5SMCJ120C | BHF | 120.0 | 133.00 | 169.00 | 1 | 214.0 | 7.0 | 5 |
| 1.5SMCJ120CA | BHG | 120.0 | 133.00 | 153.00 | 1 | 193.0 | 7.9 | 5 |
| 1.5SMCJ130C | BHH | 130.0 | 144.00 | 182.50 | 1 | 231.0 | 6.5 | 5 |
| 1.5SMCJ130CA | BHK | 130.0 | 144.00 | 165.50 | 1 | 209.0 | 7.2 | 5 |
| 1.5SMCJ150C | BHL | 150.0 | 167.00 | 211.50 | 1 | 268.0 | 5.6 | 5 |
| 1.5SMCJ150CA | BHM | 150.0 | 167.00 | 192.50 | 1 | 243.0 | 6.2 | 5 |
| 1.5SMCJ160C | BHN | 160.0 | 178.00 | 228.00 | 1 | 287.0 | 5.2 | 5 |
| 1.5SMCJ160CA | BHP | 160.0 | 178.00 | 205.00 | 1 | 259.0 | 5.8 | 5 |
| 1.5SMCJ170C | BHQ | 170.0 | 189.00 | 239.50 | 1 | 304.0 | 4.9 | 5 |
| 1.5SMCJ170CA | BHR | 170.0 | 189.00 | 217.50 | 1 | 275.0 | 5.5 | 5 |