



Micro Commercial Components

Micro Commercial Components  
 20736 Marilla Street Chatsworth  
 CA 91311  
 Phone: (818) 701-4933  
 Fax: (818) 701-4939

# 112KD10NX\* thru 120MD10NX\*

## Features

- Radial-Lead Varistor
- Designed to be Operated Continuously Across AC Power Lines
- No Derating Up to 85°C Ambient
- Available in Tape and Reel or Bulk Pack
- UL Recognized File # E306895(UL1449) and E306942(UL1414)

**6 to 680 Volts  
 Varistor  
 2.0 to 124.0 Joule**

## Maximum Ratings

- Operating Ambient Temperature Range: -55°C to +85°C
- Storage Temperature Range: -55°C to +125°C
- Temperature Coefficient ( $\alpha V$ ) of Clamping Voltage ( $V_C$ ) at Specified Test Current: <0.05%/°C
- Varistor voltage temperature coefficient:

$$\frac{V_b \text{ at } 25^\circ\text{C} - V_b \text{ at } 85^\circ\text{C}}{V_b \text{ at } 25^\circ\text{C}} \times \frac{1}{60} \times (100/^\circ\text{C})$$

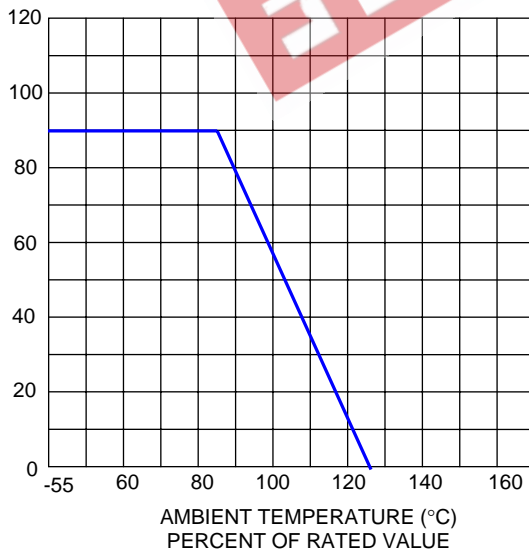

CURRENT, ENERGY AND POWER DERATING CURVE

Note : \* 'X' can be S, C, I or Y .  
 'S' denotes straight lead  
 'C' denotes out crimped lead  
 'I' denotes inner crimped lead  
 'Y' denotes kink lead

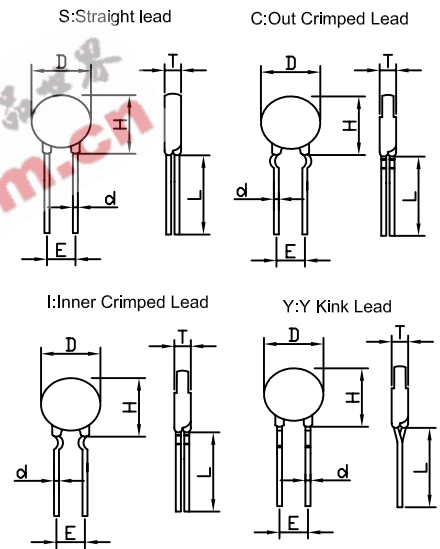

L: 20mm Min.

DIMENSIONS				Unit: mm	
Size	D max	H max		D± 0.05	E± 1.0
Lead	All	S	C/I/Y	All	All
05D	7.5	11	13	0.6	5
07D	9	13	15	0.6	5
10D	12.5	18	19.5	0.6	5
				0.8	7.5
14D	16.5	22	23	0.8	7.5
				1	10
20D	23	28	30	0.8	7.5
				1	10

**Electrical Characteristics @ 25°C Unless Otherwise Noted**

Part Number	Maximum Allowable Voltage		Maximum Energy	Withstanding Surge Current		Rated Wattage (W)	Varistor Voltage	Maximum Clamping Voltage			
	ACrms	DC	10/1000us	1 time	2 times		V1mA	V25A			
	(V)	(V)	(J)	(A)		(V)	(V)				
112KD10N X	680	895	124.0	2500	1250	0.4	1100(990-1210)	1815			
102KD10N X	625	825	112.0				1000(900-1100)	1650			
911KD10N X	550	745	102.0				910(819-1001)	1500			
821KD10N X	510	670	94.0				820(738-902)	1355			
781KD10N X	485	640	92.0				780(702-858)	1290			
751KD10N X	460	615	90.0				750(675-825)	1240			
681KD10N X	420	560	86.0				680(612-748)	1120			
621KD10N X	385	505	82.0				620(558-682)	1025			
561KD10N X	350	460	78.0				560(504-616)	920			
511KD10N X	320	418	74.0				510(459-561)	845			
471KD10N X	300	385	70.0				470(423-517)	775			
431KD10N X	275	350	66.0				430(387-473)	710			
391KD10N X	250	320	60.0				390(351-429)	650			
361KD10N X	230	300	52.0				360(324-396)	595			
331KD10N X	210	275	46.0				330(297-363)	550			
301KD10N X	195	250	42.0				300(270-330)	505			
271KD10N X	175	225	39.5				270(243-297)	455			
241KD10N X	150	200	33.5				240(216-264)	395			
221KD10N X	140	180	31.0				220(198-242)	360			
201KD10N X	130	170	28.5				200(185-225)	330			
181KD10N X	115	150	26.5				180(162-198)	300			
151KD10N X	95	125	22.0				150(135-165)	250			
121KD10N X	75	100	16.0				120(108-132)	200			
101KD10N X	60	85	14.0				100(90-110)	165			
820KD10N X	50	65	11.0				82(74-90)	135			
680KD10N X	40	56	8.5	500	250	0.05	68(61-75)	*135			
560KD10N X	35	45	7.0				56(50-62)	*110			
470KD10N X	30	38	6.0				47(42-52)	*93			
390KD10N X	25	31	4.7				39(35-43)	*77			
330KD10N X	20	26	4.4				33(30-36)	*65			
270KD10N X	17	22	3.5				27(24-30)	*53			
220KD10N X	14	18	2.7				22(20-24)	*43			
180LD10 N X	11	14	2.4				18(15-21)	*36			
120MD10N X	6	8	2.0				250	125	0.05	12(9.6-14.4)	*34

\*680K-120M Max. Clamping Voltage testing current 5A

V-I Curve (180L to 680K)

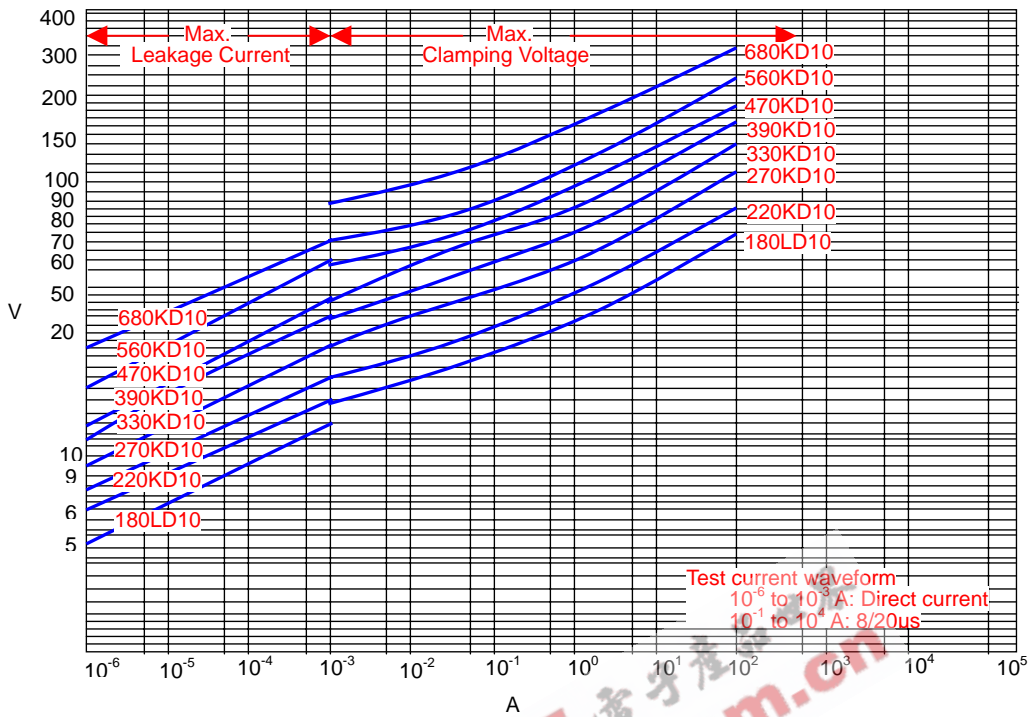

V-I Curve (820K to 561K)

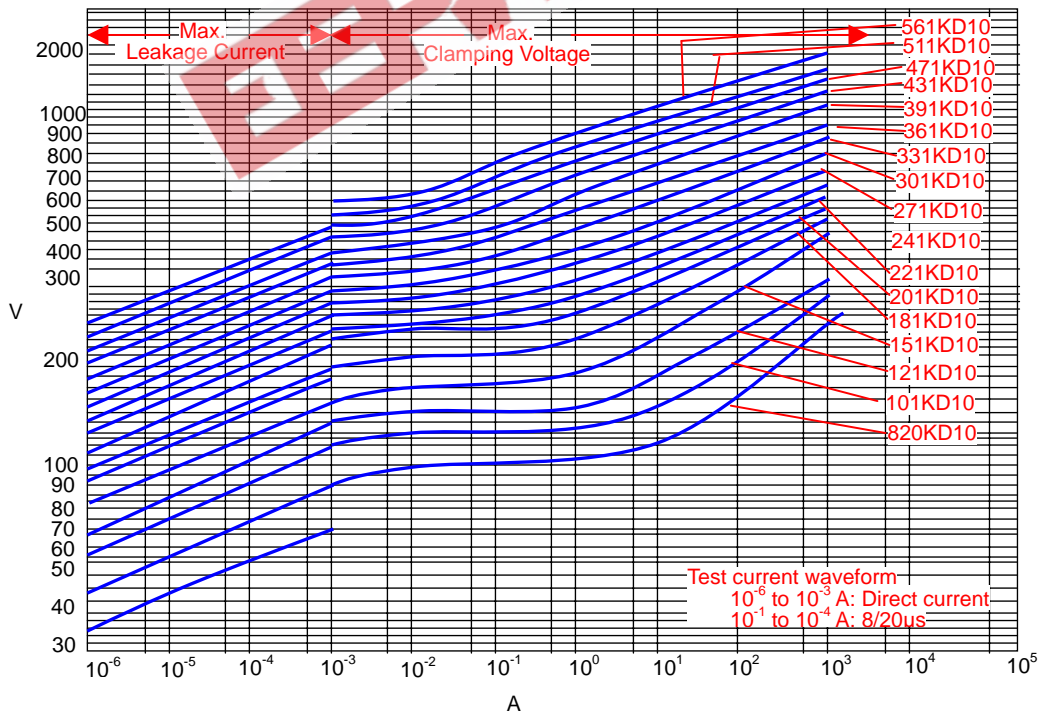

V-I Curve (621K to 182K)

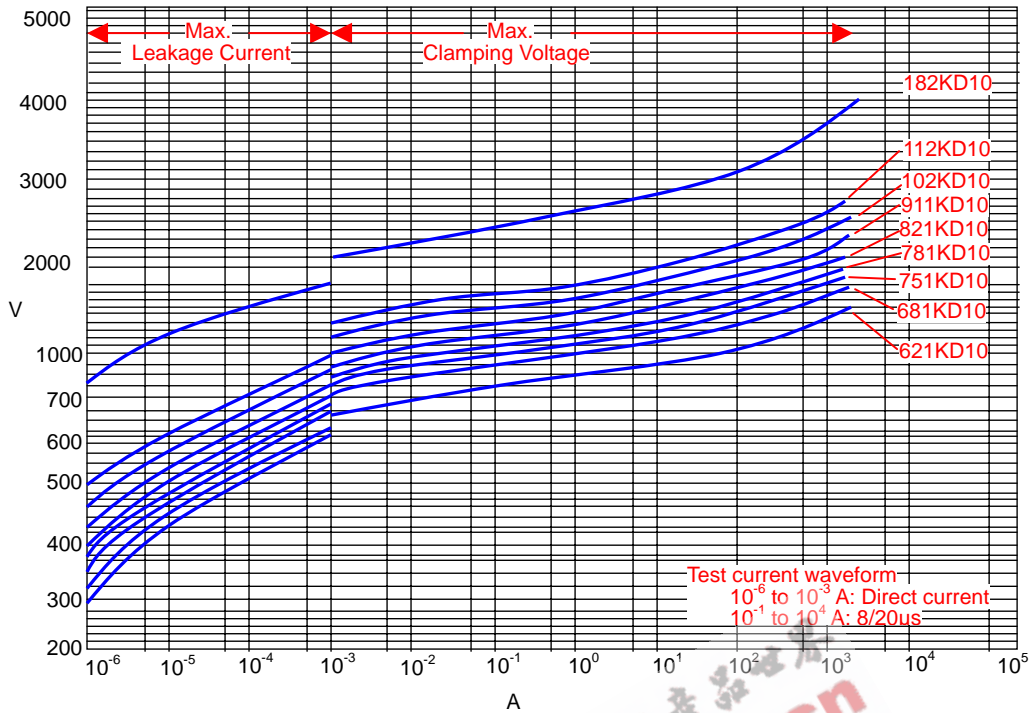

V-I Surge Life Time Ratings (180L to 680K)

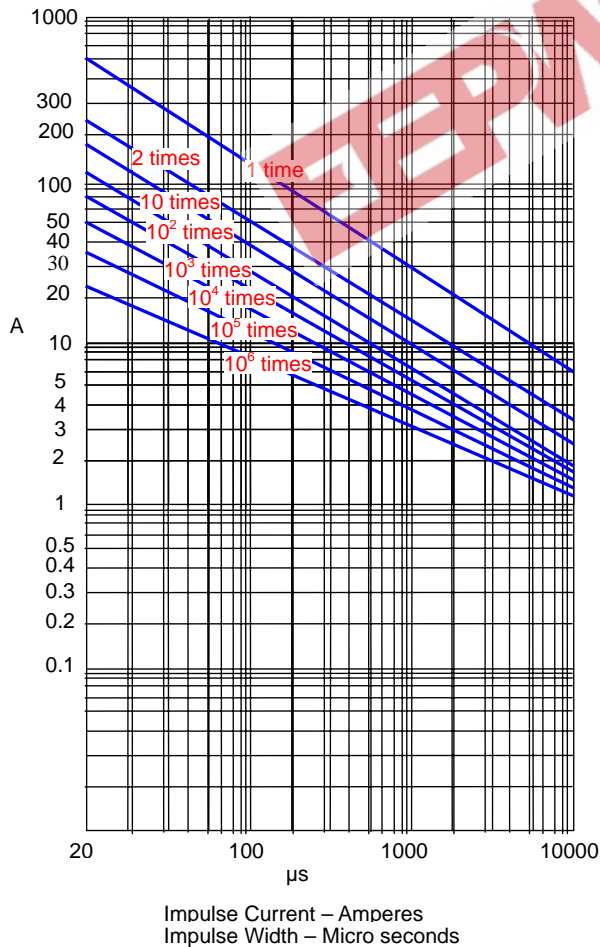

V-I Surge Life Time Ratings (820K to 182K)

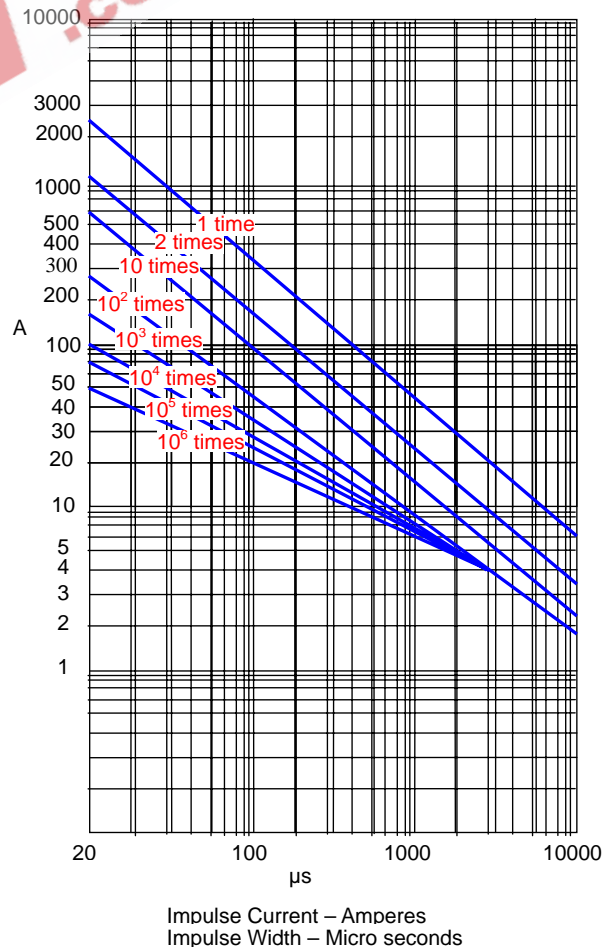

Note 2.

T Thickness (max.)

Unit:mm

Part Code	D05	D07	D10	D14	D20
182K			12.6	12.8	13.5
112K			10.5	10.7	11.2
102K			9.9	10.1	10.7
911K			9.4	9.6	10.1
821K		8.3	8.8	9.0	9.5
781K		8.1	8.6	8.8	9.3
751K	7.9	7.9	8.4	8.6	9.1
681K	7.5	7.5	8.0	8.2	8.7
621K	7.2	7.2	7.6	7.8	8.3
561K	6.9	6.9	7.3	7.5	8.0
511K	6.6	6.6	7.0	7.2	7.7
471K	6.4	6.4	6.8	7.0	7.5
431K	6.1	6.1	6.5	6.7	7.2
391K	5.3	5.3	5.7	5.9	6.4
361K	5.1	5.1	5.5	5.7	6.2
331K	4.9	4.9	5.3	5.5	6.0
301K	4.8	4.8	5.2	5.4	5.9
271K	4.6	4.6	5.0	5.2	5.7
241K	4.4	4.4	4.8	5.0	5.5
221K	4.3	4.3	4.7	4.9	5.4
201K	4.2	4.2	4.6	4.8	5.3
181K	4.1	4.1	4.5	4.7	5.2
151K	4.5	4.5	4.9	5.1	5.6
121K	4.1	4.1	4.5	4.6	5.3
101K	3.9	3.9	4.4	4.5	5.1
820K	3.8	3.8	4.3	4.4	4.9
680K	5.5	5.5	6.0	6.1	6.1
560K	5.0	5.0	5.5	5.6	5.6
470K	5.0	5.0	5.5	5.6	5.6
390K	4.7	4.7	5.1	5.2	5.4
330K	4.7	4.7	5.1	5.2	5.4
270K	4.7	4.7	5.1	5.2	5.4
220K	4.5	4.5	4.9	5.0	5.3
180L	4.5	4.5	4.9	5.0	5.2



TM

Micro Commercial Components

**\*\*\*IMPORTANT NOTICE\*\*\***

*Micro Commercial Components Corp.* reserves the right to make changes without further notice to any product herein to make corrections, modifications, enhancements, improvements, or other changes. *Micro Commercial Components Corp.* does not assume any liability arising out of the application or use of any product described herein; neither does it convey any license under its patent rights, nor the rights of others. The user of products in such applications shall assume all risks of such use and will agree to hold *Micro Commercial Components Corp.* and all the companies whose products are represented on our website, harmless against all damages.

**\*\*\*APPLICATIONS DISCLAIMER\*\*\***

Products offer by *Micro Commercial Components Corp.* are not intended for use in Medical, Aerospace or Military Applications.

EEPW.com.cn  
电子世界