

DESCRIPTION:

The KW1-501 series is 0.50 inch (12.70mm) height single digit display with right DP designed for viewing distances of up to six meters. This series is suitable for use in instruments, point of sales terminals and electrical appliances. All devices are available as either common anode or common cathode.

ABSOLUTE MAXIMUM RATINGS: (Ta=25°C)

Parameter	Max
Reverse Voltage per segment	5 V
Reverse Current per segment (Vr = 5V)	100μA
Derating Linear from 25°C per segment	0.4mA/ °C
Operating Temperature Range	-40°C To 85°C
Storage Temperature Range	-40°C To 100°C
Soldering Temperature 1.6mm(1/16") from body for 5 sec. at 260°C	

- NOTES : 1. All dimensions are in millimeters (inches).
 2. Tolerance is ±0.25mm(0.010) unless otherwise specified.
 3. Specifications are subject to change without notice.
 4. NP: No Pin.
 5. NC: No Connect.

TESTING CONDITION FOR EACH PARAMETER :

Parameter	Symbol	Unit	Test Condition
Forward Voltage	Vf	V	If=20mA
Peak Emission Wave Length	λp	nm	If=20mA
Spectral Line Half-Width	Δλ	nm	If=20mA
Reverse Current	Ir	μA	Vr=5V
Average Luminous Intensity	Iv	μcd	If=10mA

PACKAGE DIMENSIONS

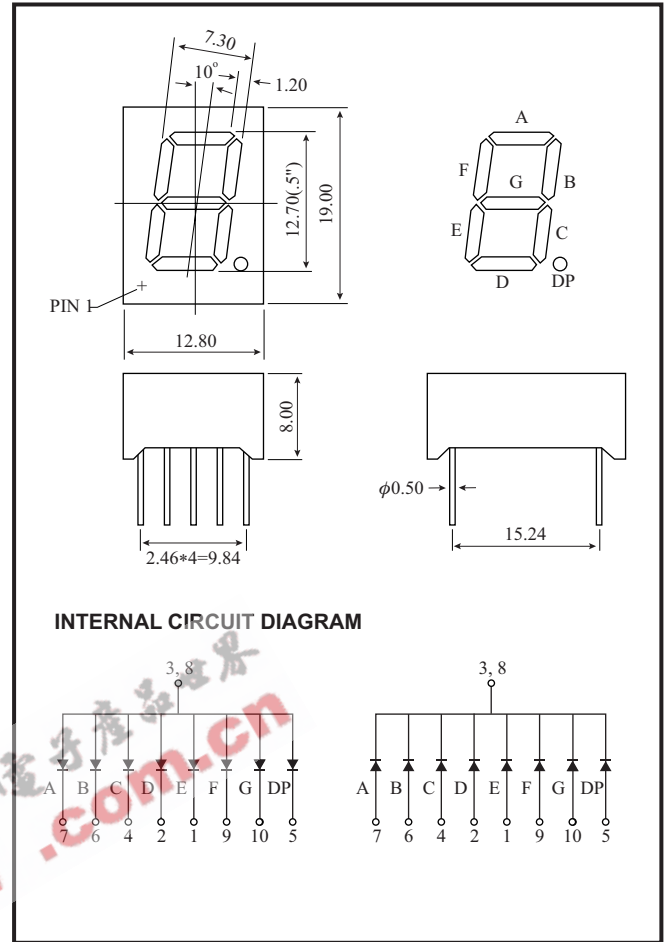

PART NO. SELECTION AND APPLICATION INFORMATION (RATINGS AT 25°C AMBIENT)

Part No.	Chip		C.C or C.A	Wave Length λp (nm)	Absolute Maximum Ratings				Electro-optical Data(at 10mA)					
	Raw Material	Emitted Color			Δλ (nm)	Pd (mW)	If (mA)	If (Peak) (mA)	Vf (V) Per Segment			If (Rec) (mA)	Iv (μcd) Per Segment	
									Min.	Typ.	Max.		Min.	Typ.
KW1-501A3	GaAsP/GaP	Hi-Eff. Red	Common Anode	635	45	100	50	100	1.7	1.9	2.6	10-20	700	2000
KW1-501AS	GaAlAs	Super Red		660	20	100	50	100	1.5	1.9	2.6	10-20	5600	21000
KW1-501A2	GaP	Green		565	30	100	50	100	1.7	2.2	2.6	10-20	750	2000
KW1-501AG	GaP	Super Green		570	30	100	50	100	1.7	2.2	2.6	10-20	850	2200
KW1-501A6	GaAsP/GaP	Yellow		585	30	100	50	100	1.7	1.9	2.6	10-20	700	1600
KW1-501C3	GaAsP/GaP	Hi-Eff Red	Common Cathode	635	45	100	50	100	1.7	1.9	2.6	10-20	750	2000
KW1-501CS	GaAlAs	Super Red		660	20	100	50	100	1.5	1.9	2.6	10-20	5600	21000
KW1-501C2	GaP	Green		565	30	100	50	100	1.7	2.2	2.6	10-20	750	2000
KW1-501CG	GaP	Super Green		570	30	100	50	100	1.7	2.2	2.6	10-20	850	2200
KW1-501C6	GaAsP/GaP	Yellow		585	30	100	50	100	1.7	1.9	2.6	10-20	700	1600

- REMARKS : 1. The average luminous intensity is obtained by summing the luminous intensity of each segment and dividing by the total number of segments.
 2. Luminous intensity is measured with a light sensor and filter combination that approximates the CIE (International Commission on Illumination) eye-response curve.
 3. Clean only by pure water, isopropanol, ethanol, Freon TF (or equivalent).