

1.5SMCJ SERIES

SURFACE MOUNT TRANSIENT VOLTAGE SUPPRESSOR VOLTAGE – 5.0-170 Volts Peak Pulse Power-1500 Watts

FEATURES

- For surface mounted applications in order to optimize board space
- Low profile package
- Built-in strain relief
- Glass passivated junction
- Excellent clamping capability
- Low inductance
- Repetition Rate (duty cycle): 0.05%
- Fast response time: typically less than 1.0ps from 0 volts to BV min.
- Typical I_b less than $1\mu A$ above 10V
- High temperature soldering:
260°C/10 seconds at terminals
- Plastic package has Underwriters Laboratory Flammability Classification 94V-0

SMC/DO-214AB

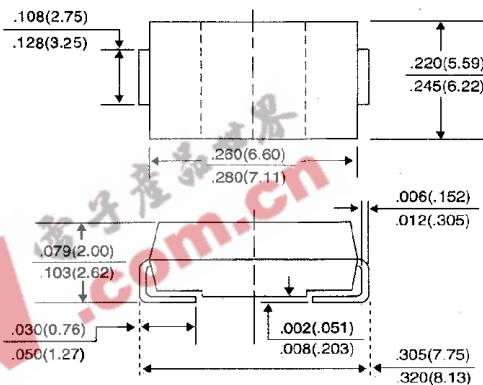

Dimensions in inches and (millimeters)

MECHANICAL DATA

Case: JEDEC DO-214AB molded plastic over passivated junction
 Terminals: Solder plated, solderable per MIL-STD-750, Method 2026
 Polarity: Color band denotes positive end (cathode) except bi-directional types
 Standard Packaging: 16mm tape (EIA-481)
 Weight: .007 ounces, 0.21 gram

MAXIMUM RATINGS AND ELECTRICAL CHARACTERISTICS

Ratings at 25°C ambient temperature unless otherwise specified.

	SYMBOLS	VALUE	UNITS
Peak Pulse Power Dissipation on 10/1000 μs waveform (Notes 1, 2, Fig. 1)	P_{PPM}	Minimum 1500	Watts
Peak Pulse Current on 10/1000 μs waveform (Note 1, Fig. 3)	I_{PPM}	See Table 1	Amps
Peak forward Surge Current 8.3ms single half sine-wave superimposed on rated load (JEDEC Method) (NOTES 2,3)	I_{FSM}	100.0	Amps
Operating Junction and Storage Temperature Range	T_J, T_{STG}	-55 to +150	°C

NOTES:

1. Non-repetitive current pulse, per Fig.3 and derated above $T_A = 25^\circ C$ per Fig. 2.
2. Mounted on 8.0mm² copper pads to each terminal.
3. 8.3ms single half sine-wave, or equivalent square wave, duty cycle = 4 pulses per minutes maximum.

RATING AND CHARACTERISTIC CURVES 1.5SMCJ SERIES



FIG. 2-PULSE RATING CURVE



FIG. 3-PULSE WAVEFORM



FIG. 4-TYPICAL JUNCTION CAPACITANCE



FIG. 5-MAXIMUM NON-REPETITIVE
PEAK FORWARD SURGE CURRENT



UNI-DIRECTIONAL 1500 Watt Surface Mount TVS

UNI-DIRECTIONAL PART NUMBER	DEVICE MARKING CODE	REVERSE STAND-OFF VOLTAGE VRWM (V)	BREAKDOWN VOLTAGE VBR (V) MIN. @ IT	BREAKDOWN VOLTAGE VBR (V) MAX. @ IT	TEST CURRENT IT (mA)	MAXIMUM CLAMPING VOLTAGE @Ipp Vc (V)	PEAK PULSE CURRENT Ipp (A)	REVERSE LEAKAGE @VRWM IR (uA)
1.5SMCJ5.0	GDD	5.0	6.40	7.55	10	9.6	156.2	1000
1.5SMCJ5.0A	GDE	5.0	6.40	7.25	10	9.2	163.0	1000
1.5SMCJ6.0	GDF	6.0	6.67	8.45	10	11.4	131.6	1000
1.5SMCJ6.0A	GDG	6.0	6.67	7.67	10	10.3	145.6	1000
1.5SMCJ6.5	GDH	6.5	7.22	9.14	10	12.3	122.0	500
1.5SMCJ6.5A	GDK	6.5	7.22	8.30	10	11.2	133.9	500
1.5SMCJ7.0	CDL	7.0	7.78	9.86	10	13.3	112.8	200
1.5SMCJ7.0A	GDM	7.0	7.78	8.95	10	12.0	125.0	200
1.5SMCJ7.5	GDN	7.5	8.33	10.67	1	14.3	104.9	100
1.5SMCJ7.5A	GDP	7.5	8.33	9.58	1	12.9	116.3	100
1.5SMCJ8.0	GDO	8.0	8.89	11.30	1	15.0	100.0	50
1.5SMCJ8.0A	GDR	8.0	8.89	10.23	1	13.6	110.3	50
1.5SMCJ8.5	GDS	8.5	9.44	11.92	1	15.9	94.3	25
1.5SMCJ8.5A	GDT	8.5	9.44	10.82	1	14.4	104.2	20
1.5SMCJ9.0	GDU	9.0	10.00	12.60	1	16.9	88.7	10
1.5SMCJ9.0A	GDV	9.0	10.00	11.50	1	15.4	97.4	10
1.5SMCJ10	GDW	10.0	11.10	14.10	1	18.8	79.8	5
1.5SMCJ10A	GDX	10.0	11.10	12.80	1	17.0	88.2	5
1.5SMCJ11	GDY	11.0	12.20	15.40	1	20.1	74.6	5
1.5SMCJ11A	GDZ	11.0	12.20	14.00	1	18.2	82.4	5
1.5SMCJ12	GED	12.0	13.30	16.90	1	22.0	68.2	5
1.5SMCJ12A	GEE	12.0	13.30	15.30	1	19.9	75.3	5
1.5SMCJ13	GEF	13.0	14.40	18.20	1	23.8	63.0	5
1.5SMCJ13A	GEG	13.0	14.40	16.50	1	21.5	69.7	5
1.5SMCJ14	GEH	14.0	15.60	19.80	1	25.8	58.7	5
1.5SMCJ14A	GEK	14.0	15.60	17.90	1	23.2	64.7	5
1.5SMCJ15	GEL	15.0	16.70	21.10	1	29.9	55.8	5
1.5SMCJ15A	GEM	15.0	16.70	19.20	1	24.4	61.5	5
1.5SMCJ16	GEN	16.0	17.80	22.60	1	28.4	52.1	5
1.5SMCJ16A	GEP	16.0	17.80	20.50	1	26.0	57.7	5
1.5SMCJ17	GEQ	17.0	18.90	23.90	1	30.5	49.2	5
1.5SMCJ17A	GER	17.0	18.90	21.70	1	27.6	53.3	5
1.5SMCJ18	GES	18.0	20.00	25.30	1	32.2	46.6	5
1.5SMCJ18A	GET	18.0	20.00	23.30	1	29.2	51.4	5
1.5SMCJ20	GEU	20.0	22.20	28.10	1	35.8	41.9	5
1.5SMCJ20A	GEV	20.0	22.20	25.50	1	32.4	46.3	5
1.5SMCJ22	GEW	22.0	24.40	30.90	1	39.4	38.1	5
1.5SMCJ22A	GEX	22.0	24.40	28.00	1	35.5	42.2	5
1.5SMCJ24	GEY	24.0	26.70	33.80	1	43.0	34.9	5
1.5SMCJ24A	GEZ	24.0	26.70	30.70	1	38.9	38.8	5
1.5SMCJ26	GFD	26.0	28.90	36.60	1	46.6	32.2	5
1.5SMCJ26A	GFE	26.0	28.90	33.20	1	42.1	35.6	5
1.5SMCJ28	GFF	28.0	31.10	39.40	1	50.0	30.0	5
1.5SMCJ28A	GFG	28.0	31.10	35.80	1	45.4	33.0	5
1.5SMCJ30	GFH	30.0	33.30	42.20	1	53.5	28.0	5
1.5SMCJ30A	GFK	30.0	33.30	38.30	1	48.4	31.0	5
1.5SMCJ33	GFL	33.0	36.70	46.50	1	59.0	25.2	5
1.5SMCJ33A	GFM	33.0	36.70	42.20	1	53.3	28.1	5
1.5SMCJ36	GFN	36.0	40.00	50.70	1	64.3	23.3	5
1.5SMCJ36A	GFP	36.0	40.00	46.00	1	58.1	25.8	5
1.5SMCJ40	GFQ	40.0	44.40	56.30	1	71.4	21.0	5
1.5SMCJ40A	GFR	40.0	44.40	51.10	1	64.5	23.2	5
1.5SMCJ43	GFS	43.0	47.80	60.50	1	76.7	19.6	5
1.5SMCJ43A	GFT	43.0	47.80	54.90	1	69.4	21.6	5
1.5SMCJ45	GFU	45.0	50.00	63.30	1	80.3	18.7	5
1.5SMCJ45A	GFV	45.0	50.00	57.50	1	72.7	20.6	5
1.5SMCJ48	GFW	48.0	53.30	67.50	1	85.5	17.6	5
1.5SMCJ48A	GFX	48.0	53.30	61.30	1	77.4	19.4	5
1.5SMCJ51	GFY	51.0	56.70	71.80	1	91.1	15.5	5
1.5SMCJ51A	GFZ	51.0	56.70	65.20	1	82.4	18.2	5
1.5SMCJ54	GGD	54.0	60.00	76.00	1	96.3	15.6	5
1.5SMCJ54A	GGE	54.0	60.00	69.00	1	87.1	17.2	5
1.5SMCJ58	GGF	58.0	64.40	81.60	1	103.0	14.6	5
1.5SMCJ58A	GGG	58.0	64.40	74.10	1	93.6	16.0	5
1.5SMCJ60	GGH	60.0	66.70	84.50	1	107.0	14.0	5
1.5SMCJ60A	GGK	60.0	66.70	76.70	1	96.8	15.5	5
1.5SMCJ64	GGL	64.0	71.10	90.10	1	114.0	13.2	5
1.5SMCJ64A	GGM	64.0	71.10	81.80	1	103.0	14.6	5
1.5SMCJ70	GGN	70.0	77.80	98.60	1	125.0	12.0	5
1.5SMCJ70A	GGP	70.0	77.80	89.50	1	115.0	13.3	5
1.5SMCJ75	GGQ	75.0	83.30	105.70	1	134.0	11.2	5
1.5SMCJ75A	GGR	75.0	83.30	95.80	1	121.0	12.4	5
1.5SMCJ78	GGS	78.0	86.70	109.80	1	139.0	10.8	5
1.5SMCJ78A	GGT	78.0	86.70	99.70	1	126.0	11.4	5
1.5SMCJ85	GGU	85.0	94.40	119.20	1	151.0	9.9	5
1.5SMCJ85A	GGV	85.0	94.40	108.20	1	137.0	10.4	5
1.5SMCJ90	GGW	90.0	100.00	126.50	1	160.0	9.4	5
1.5SMCJ90A	GGX	90.0	100.00	115.50	1	146.0	10.3	5
1.5SMCJ100	GGY	100.0	111.00	141.00	1	179.0	8.4	5
1.5SMCJ100A	GGZ	100.0	111.00	128.00	1	162.0	9.3	5
1.5SMCJ110	GHD	110.0	122.00	154.50	1	196.0	7.7	5
1.5SMCJ110A	GHE	110.0	122.00	140.50	1	177.0	8.4	5
1.5SMCJ120	GHF	120.0	133.00	169.00	1	214.0	7.0	5
1.5SMCJ120A	GHG	120.0	133.00	153.00	1	193.0	7.9	5
1.5SMCJ130	GHH	130.0	144.00	182.50	1	231.0	6.5	5
1.5SMCJ130A	GHK	130.0	144.00	165.50	1	209.0	7.2	5
1.5SMCJ150	GHL	150.0	167.00	211.50	1	268.0	5.6	5
1.5SMCJ150A	GHM	150.0	167.00	192.50	1	243.0	6.2	5
1.5SMCJ160	GHN	160.0	178.00	226.00	1	287.0	5.2	5
1.5SMCJ160A	GHP	160.0	178.00	205.00	1	269.0	5.8	5
1.5SMCJ170	GHQ	170.0	189.00	239.50	1	304.0	4.9	5
1.5SMCJ170A	GHR	170.0	189.00	217.50	1	275.0	5.5	5



BI-DIRECTIONAL 1500 Watt Surface Mount TVS

BI-DIRECTIONAL PART NUMBER	DEVICE MARKING CODE	REVERSE STAND-OFF VOLTAGE VRWM (V)	BREAKDOWN VOLTAGE VBR (V) MIN. @ IT	BREAKDOWN VOLTAGE VBR (V) MAX. @ IT	TEST CURRENT IT (mA)	MAXIMUM CLAMPING VOLTAGE @Ipp Vc (V)	PEAK PULSE CURRENT Ipp (A)	REVERSE LEAKAGE @VRWM IR (uA)
1.5SMCJ5.0C	BDD	5.0	6.40	7.55	10	9.6	156.2	2000
1.5SMCJ5.0CA	BDE	5.0	6.40	7.25	10	9.2	163.0	2000
1.5SMCJ6.0C	BDF	6.0	6.67	8.45	10	11.4	131.6	2000
1.5SMCJ6.0CA	BDG	6.0	6.67	7.67	10	10.3	145.6	2000
1.5SMCJ6.5C	BDH	6.5	7.22	9.14	10	12.3	122.0	1000
1.5SMCJ6.5CA	BDK	6.5	7.22	8.30	10	11.2	133.9	1000
1.5SMCJ7.0C	BDL	7.0	7.78	9.86	10	13.3	112.8	400
1.5SMCJ7.0CA	BDM	7.0	7.78	8.95	10	12.0	125.0	400
1.5SMCJ7.5C	BDN	7.5	8.33	10.67	1	14.3	104.9	200
1.5SMCJ7.5CA	BDP	7.5	8.33	9.58	1	12.9	116.3	200
1.5SMCJ8.0C	BDQ	8.0	8.89	11.30	1	15.0	100.0	100
1.5SMCJ8.0CA	BDR	8.0	8.89	10.23	1	13.6	110.3	100
1.5SMCJ8.5C	BDS	8.5	9.44	11.92	1	15.9	94.3	50
1.5SMCJ8.5CA	BDT	8.5	9.44	10.82	1	14.4	104.2	50
1.5SMCJ9.0C	BDU	9.0	10.00	12.60	1	16.9	88.7	20
1.5SMCJ9.0CA	BDV	9.0	10.00	11.50	1	15.4	97.4	20
1.5SMCJ10C	BDW	10.0	11.10	14.10	1	18.8	79.8	5
1.5SMCJ10CA	BDX	10.0	11.10	12.80	1	17.0	88.2	5
1.5SMCJ11C	BDY	11.0	12.20	15.40	1	20.1	74.6	5
1.5SMCJ11CA	BDZ	11.0	12.20	14.00	1	18.2	82.4	5
1.5SMCJ12C	BED	12.0	13.30	16.90	1	22.0	66.2	5
1.5SMCJ12CA	BEE	12.0	13.30	15.30	1	19.9	75.3	5
1.5SMCJ13C	BEF	13.0	14.40	18.20	1	23.8	63.0	5
1.5SMCJ13CA	BEG	13.0	14.40	16.50	1	21.5	69.7	5
1.5SMCJ14C	BEH	14.0	15.60	19.80	1	25.8	58.1	5
1.5SMCJ14CA	BEK	14.0	15.60	17.90	1	23.2	64.7	5
1.5SMCJ15C	BEL	15.0	16.70	21.10	1	26.9	55.8	5
1.5SMCJ15CA	BEM	15.0	16.70	19.20	1	24.4	61.5	5
1.5SMCJ16C	BEN	16.0	17.80	22.60	1	28.8	52.1	5
1.5SMCJ16CA	BEP	16.0	17.80	20.50	1	26.0	57.7	5
1.5SMCJ17C	BEQ	17.0	18.90	23.90	1	30.5	49.2	5
1.5SMCJ17CA	BER	17.0	18.90	21.70	1	27.6	53.3	5
1.5SMCJ18C	BES	18.0	20.00	25.30	1	32.2	46.6	5
1.5SMCJ18CA	BET	18.0	20.00	23.30	1	29.2	51.4	5
1.5SMCJ20C	BEU	20.0	22.20	28.10	1	35.8	41.9	5
1.5SMCJ20CA	BEV	20.0	22.20	25.50	1	32.4	46.3	5
1.5SMCJ22C	BEW	22.0	24.40	30.90	1	39.4	38.1	5
1.5SMCJ22CA	BFX	22.0	24.40	28.00	1	35.5	42.2	5
1.5SMCJ24C	BEY	24.0	26.70	33.80	1	43.0	34.9	5
1.5SMCJ24CA	BEZ	24.0	26.70	30.70	1	38.9	38.6	5
1.5SMCJ26C	BFD	26.0	28.90	36.60	1	46.6	32.2	5
1.5SMCJ26CA	BFE	26.0	28.90	33.20	1	42.1	35.6	5
1.5SMCJ28C	BFF	28.0	31.10	39.40	1	50.0	30.0	5
1.5SMCJ28CA	BFG	28.0	31.10	35.80	1	45.4	33.0	5
1.5SMCJ30C	BFH	30.0	33.30	42.20	1	53.5	28.0	5
1.5SMCJ30CA	BFK	30.0	33.30	38.30	1	48.4	31.0	5
1.5SMCJ33C	BFL	33.0	36.70	46.50	1	59.0	25.2	5
1.5SMCJ33CA	BFM	33.0	36.70	42.20	1	53.3	28.1	5
1.5SMCJ36C	BFN	36.0	40.00	50.70	1	64.3	23.3	5
1.5SMCJ36CA	BFP	36.0	40.00	46.00	1	58.1	25.8	5
1.5SMCJ40C	BFQ	40.0	44.40	56.30	1	71.4	21.0	5
1.5SMCJ40CA	BFR	40.0	44.40	51.10	1	64.5	23.2	5
1.5SMCJ43C	BFS	43.0	47.80	60.50	1	76.7	19.6	5
1.5SMCJ43CA	BFT	43.0	47.80	54.90	1	69.4	21.6	5
1.5SMCJ45C	BFU	45.0	50.00	63.30	1	80.3	18.7	5
1.5SMCJ45CA	BFV	45.0	50.00	57.50	1	72.7	20.6	5
1.5SMCJ48C	BFW	48.0	53.30	67.50	1	85.5	17.5	5
1.5SMCJ48CA	BFX	48.0	53.30	61.30	1	77.4	19.4	5
1.5SMCJ51C	BFY	51.0	56.70	71.80	1	91.1	18.5	5
1.5SMCJ51CA	BFZ	51.0	56.70	65.20	1	82.4	18.2	5
1.5SMCJ54C	BGD	54.0	60.00	76.00	1	96.3	15.6	5
1.5SMCJ54CA	BGE	54.0	60.00	69.00	1	87.1	17.2	5
1.5SMCJ58C	BGF	58.0	64.40	81.60	1	103.0	14.6	5
1.5SMCJ58CA	BGG	58.0	64.40	74.10	1	93.6	16.0	5
1.5SMCJ60C	BGH	60.0	66.70	84.50	1	107.0	14.0	5
1.5SMCJ60CA	BGK	60.0	66.70	76.70	1	96.8	15.5	5
1.5SMCJ64C	BGL	64.0	71.10	90.10	1	114.0	13.2	5
1.5SMCJ64CA	BGM	64.0	71.10	81.80	1	103.0	14.6	5
1.5SMCJ70C	BGN	70.0	77.80	98.60	1	125.0	12.0	5
1.5SMCJ70CA	BGP	70.0	77.80	89.50	1	113.0	13.3	5
1.5SMCJ75C	BGQ	75.0	83.30	105.70	1	134.0	11.2	5
1.5SMCJ75CA	BGR	75.0	83.30	95.80	1	121.0	12.4	5
1.5SMCJ78C	BGS	78.0	86.70	109.80	1	139.0	10.8	5
1.5SMCJ78CA	BGT	78.0	86.70	99.70	1	126.0	11.4	5
1.5SMCJ85C	BGU	85.0	94.40	119.20	1	151.0	9.9	5
1.5SMCJ85CA	BGV	85.0	94.40	108.20	1	137.0	10.4	5
1.5SMCJ90C	BGW	90.0	100.00	126.50	1	160.0	9.4	5
1.5SMCJ90CA	BGX	90.0	100.00	115.50	1	146.0	10.3	5
1.5SMCJ100C	BGY	100.0	111.00	141.00	1	179.0	8.4	5
1.5SMCJ100CA	BGZ	100.0	111.00	128.00	1	162.0	9.3	5
1.5SMCJ110C	BHD	110.0	122.00	154.50	1	196.0	7.7	5
1.5SMCJ110CA	BHE	110.0	122.00	140.50	1	177.0	8.4	5
1.5SMCJ120C	BHF	120.0	133.00	169.00	1	214.0	7.0	5
1.5SMCJ120CA	BHG	120.0	133.00	153.00	1	193.0	7.9	5
1.5SMCJ130C	BHH	130.0	144.00	182.50	1	231.0	6.5	5
1.5SMCJ130CA	BHK	130.0	144.00	165.50	1	209.0	7.2	5
1.5SMCJ150C	BHL	150.0	167.00	211.50	1	268.0	5.6	5
1.5SMCJ150CA	BHM	150.0	167.00	192.50	1	243.0	6.2	5
1.5SMCJ160C	BHN	160.0	178.00	228.00	1	287.0	5.2	5
1.5SMCJ160CA	BHP	160.0	178.00	205.00	1	259.0	5.8	5
1.5SMCJ170C	BHQ	170.0	189.00	239.50	1	304.0	4.9	5
1.5SMCJ170CA	BHR	170.0	189.00	217.50	1	275.0	5.5	5