

0.8 – 6 GHz 3 V Downconverter

Technical Data

IAM-91563

Features

- +0 dBm Input IP₃ at 1.9 GHz
- Single +3V Supply
- 8.5 dB SSB Noise Figure at 1.9 GHz
- 9.0 dB Conversion Gain at 1.9 GHz
- Ultra-miniature Package

Applications

- Downconverter for PCS, PHS, ISM, WLL, and other Wireless Applications

Surface Mount Package SOT-363 (SC-70)

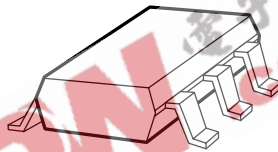

Pin Connections and Package Marking

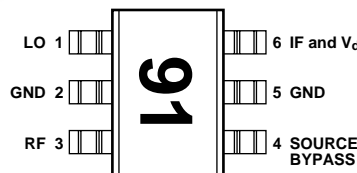

Note:

1. Package marking provides orientation and identification.

Simplified Schematic

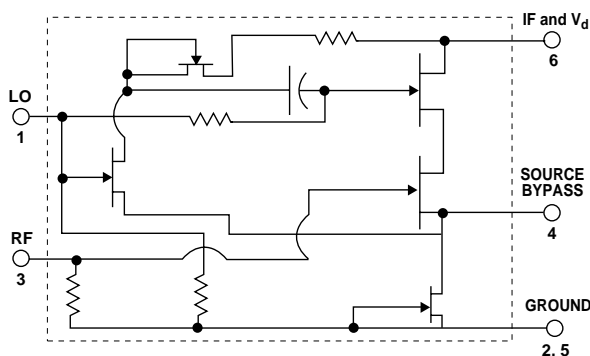

Description

Hewlett-Packard's IAM-91563 is an economical 3V GaAs MMIC mixer used for frequency down-conversion. RF frequency coverage is from 0.8 to 6 GHz and IF coverage is from 50 to 700 MHz. Packaged in the SOT-363 package, this 4.0 sq. mm. package requires half the board space of a SOT-143 and only 15% the board space of an SO-8 package.

At 1.9 GHz, the IAM-91563 provides 9 dB of conversion gain, thus eliminating an RF or IF gain stage normally needed with a lossy mixer. LO drive power is nominally only -5 dBm, eliminating an LO buffer amplifier. The 8.5 dB noise figure is low enough to allow the system to use a low cost LNA. The -6 dBm Input IP₃ provides adequate system linearity for most commercial applications, but is adjustable to 0 dBm.

The circuit uses GaAs PHEMT technology with proven reliability, and uniformity. The MMIC consists of a cascode FET structure that provides unbalanced gm modulation type mixing. An on-chip LO buffer amp drives the mixer while bias circuitry allows a single +3V supply (through a choked IF port). The LO port is internally matched to 50 Ω. The RF and IF ports are high impedance and require external matching networks.

IAM-91563 Absolute Maximum Ratings

Symbol	Parameter	Units	Absolute Maximum ^[1]
V _d	Device Voltage, RF output to ground	V	6.0
V _{RF} , V _{LO}	RF voltage or LO voltage to ground	V	+0.5, -1.0
P _{in}	CW RF Input Power	dBm	+13
T _{ch}	Channel Temperature	°C	150
T _{STG}	Storage Temperature	°C	-65 to 150

Thermal Resistance^[2]:

$$\theta_{ch-c} = 310^{\circ}\text{C/W}$$

Notes:

- Permanent damage may occur if any of these limits are exceeded.
- T_C = 25°C (T_C is defined to be the temperature at the package pins where contact is made to the circuit board).

IAM-91563 Electrical Specifications, T_C = 25°C, V_d = 3V

Symbol	Parameters and Test Conditions	Units	Min.	Typ.	Max.	Std Dev ^[2]
G _{test}	Gain in test circuit ^[1] RF=1890 GHz, IF=250 MHz	dB	4.0	9.0		
NF _{test}	Noise Figure in test circuit ^[1] RF=1890 GHz, IF=250 MHz	dB		8.5	11.0	
I _d	Device Current	mA	6.0	9.0	12.0	
NF	Noise Figure (RF & IF with external matching, IF=250 MHz, LO power=-5 dBm)	dB		7.0 8.5 11.0 16.5 18.0		0.5
G _c	Conversion gain (RF and IF with external matching, IF=250 MHz, LO power=-5 dBm)	dB		11.0 9.0 7.7 4.6 1.7		1.5
P _{1 dB}	Output power @ 1 dB compression (RF and IF with external matching, IF=250 MHz, LO power=-5 dBm)	dBm		-6.7 -8.0 -8.7 -15.0 -17.8		1.3
RL _{RF}	RF port return loss	dB		-1.7		0.2
RL _{LO}	LO port return loss	dB		-9.4		0.3
RL _{IF}	IF port return loss	dB		-3.7		0.2
IP ₃	Input Third Order Intercept Point I _d = 9.0 mA, LO power = -5 dBm	dBm		-6.0		1.3
IP ₃	Input Third Order Intercept Point I _d = 15 mA, LO power = -2 dBm	dBm		0		1.1
ISOL _{L-R}	LO-RF Isolation	dB		18		
ISOL _{R-I}	RF-IF Isolation (No Match)	dB		2		
ISOL _{L-I}	LO-IF Isolation (No Match)	dB		4		

Notes:

- Guaranteed specifications are 100% tested in the circuit in Figure 18 in the Applications Information section.
- Standard deviation number is based on measurement of at least 500 parts from three non-consecutive wafer lots during the initial characterization of this product, and is intended to be used as an estimate for distribution of the typical specification.

IAM-91563 Typical Performance, $T_C = 25^\circ\text{C}$, $V_d = 3.0\text{V}$, $R_F = 1890\text{MHz}$, $LO = -5\text{dBm}$, $IF = 250\text{MHz}$, unless otherwise stated.

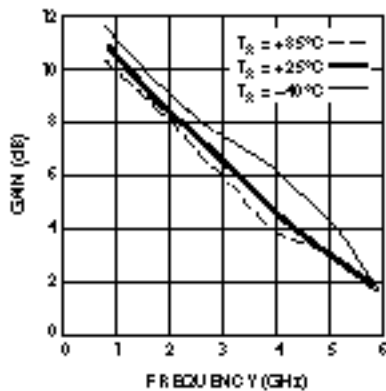

Figure 1. Available Conversion Gain vs. Frequency and Temperature.

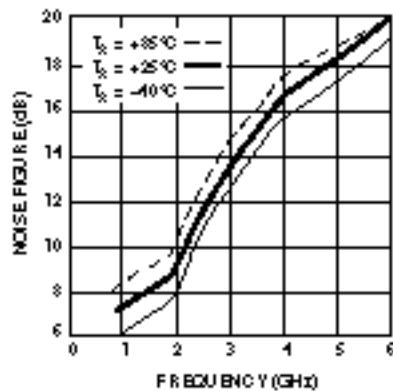

Figure 2. Noise Figure (into 50 Ω) vs. Frequency and Temperature.

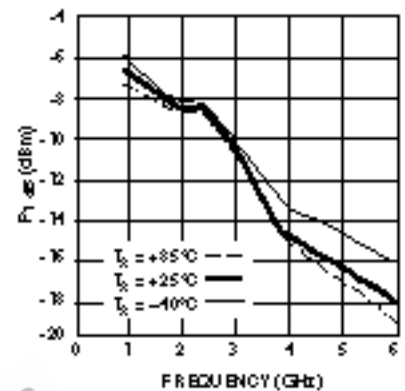

Figure 3. Output Power (⊕ 1 dB Compression) vs. Frequency and Temperature.

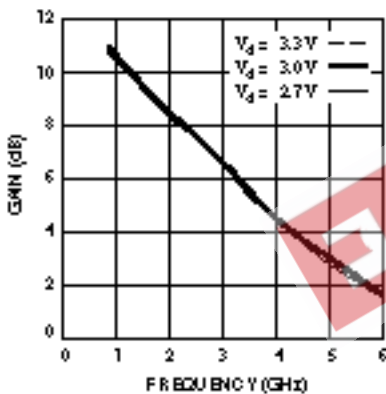

Figure 4. Available Conversion Gain vs. Frequency and Voltage.

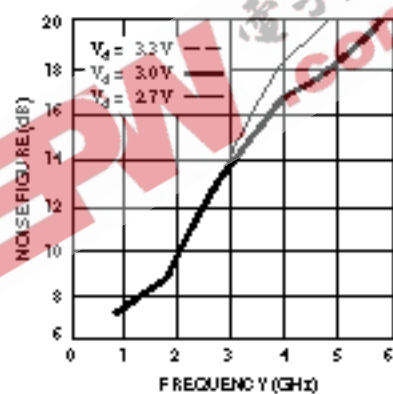

Figure 5. Noise Figure (into 50 Ω) vs. Frequency and Supply Voltage.

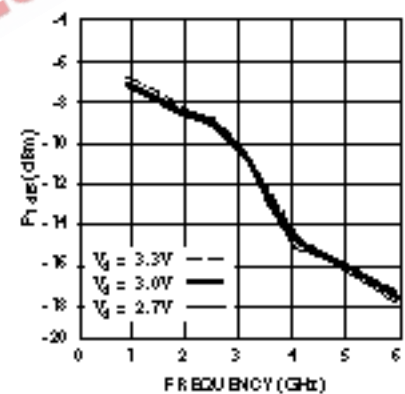

Figure 6. Output Power (⊕ 1 dB Compression) vs. Frequency and Voltage.

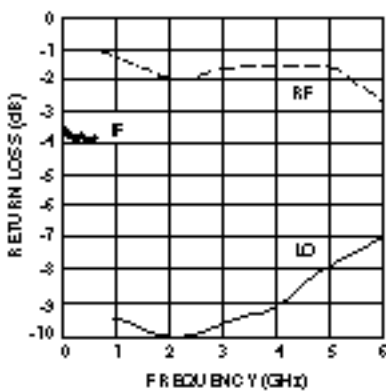

Figure 7. RF, LO, and IF Return Loss vs. Frequency.

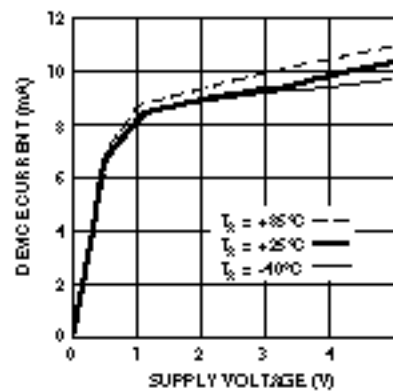

Figure 8. Device Current vs. Supply Voltage and Temperature.

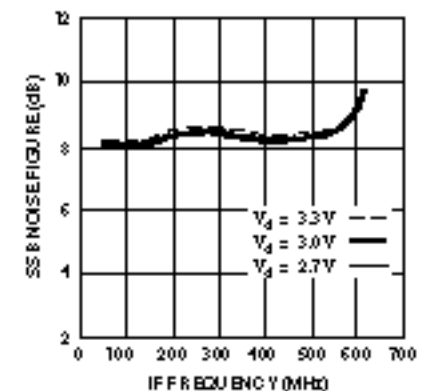

Figure 9. SSB Noise Figure vs. Frequency and Supply Voltage.

IAM-91563 Typical Performance, $T_C = 25^\circ\text{C}$, $V_d = 3.0\text{V}$, $\text{RF} = 1890\text{MHz}$, $\text{LO} = -5\text{dBm}$, $\text{IF} = 250\text{MHz}$, unless otherwise stated.

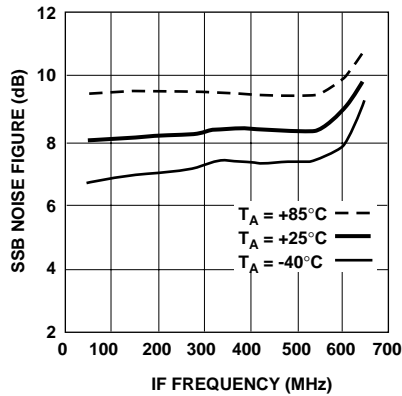

Figure 10. SSB Noise Figure vs. Frequency and Temperature.

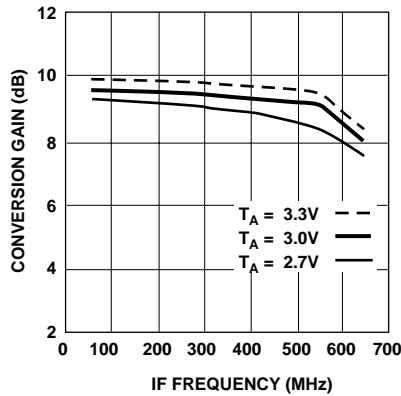

Figure 11. Conversion Gain vs. Frequency and Supply Voltage.

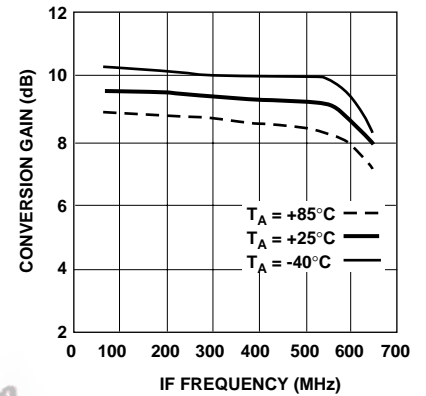

Figure 12. Conversion Gain vs. Frequency and Temperature.

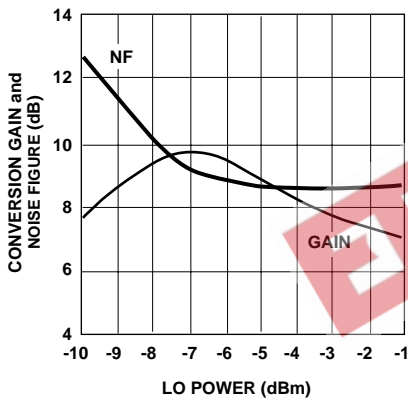

Figure 13. Available Conversion Gain and Noise Figure vs. LO Drive Power.

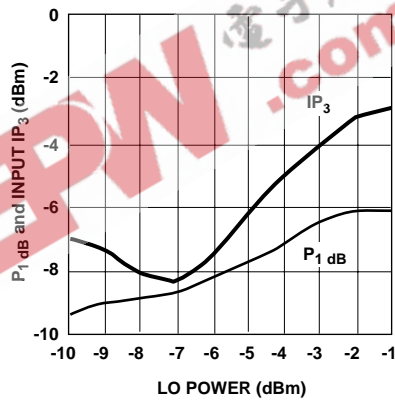

Figure 14. One dB Compression and Input Third Order Intercept vs. LO Drive Power.

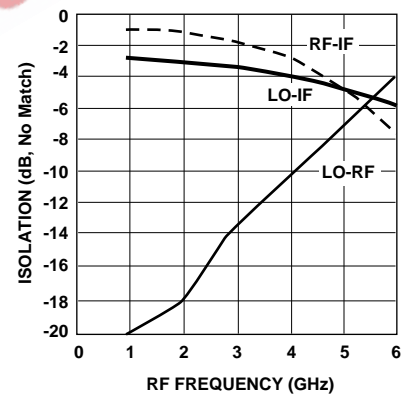

Figure 15. Isolation (LO-RF, RF-IF, LO-IF) vs. Frequency with no RF and IF Matching Networks.

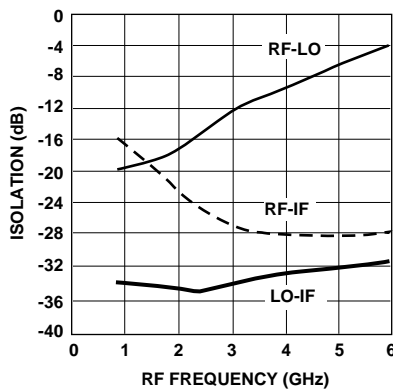

Figure 16. Isolation (RF-LO, RF-IF, LO-IF) vs. Frequency with RF and IF Matching Networks.

IAM-91563 Typical Reflection Coefficients, $T_C = 25^\circ\text{C}$, $Z_0 = 50\ \Omega$, $V_d = 3\ \text{V}$

Frequency (GHz)	RF (Mag)	RF (Ang)	LO (Mag)	LO (Ang)	IF (Mag)	IF (Ang)
0.1			0.43	-1	0.64	-8
0.2			0.39	-6	0.63	-9
0.3			0.39	-8	0.63	-10
0.4			0.39	-9	0.63	-10
0.5			0.39	-10	0.62	-11
0.6			0.39	-11	0.62	-12
0.7			0.40	-14	0.62	-13
0.8	0.91	-18	0.39	-14		
0.9	0.91	-21	0.39	-16		
1	0.91	-23	0.38	-17		
1.1	0.92	-25	0.39	-17		
1.2	0.91	-28	0.39	-19		
1.3	0.88	-29	0.40	-22		
1.4	0.87	-32	0.39	-22		
1.5	0.85	-33	0.39	-24		
1.6	0.84	-34	0.39	-25		
1.7	0.83	-35	0.39	-26		
1.8	0.82	-37	0.39	-27		
1.9	0.82	-37	0.38	-29		
2	0.81	-39	0.39	-29		
2.1	0.81	-40	0.38	-31		
2.2	0.81	-41	0.38	-31		
2.3	0.81	-42	0.37	-32		
2.4	0.81	-44	0.37	-33		
2.5	0.80	-45	0.36	-34		
2.6	0.80	-45	0.36	-35		
2.7	0.81	-46	0.35	-36		
2.8	0.81	-48	0.35	-36		
2.9	0.81	-50	0.34	-37		
3	0.82	-51	0.34	-37		
3.1	0.83	-53	0.33	-38		
3.2	0.83	-55	0.33	-39		
3.3	0.83	-56	0.32	-39		
3.4	0.85	-59	0.32	-40		
3.5	0.86	-61	0.31	-40		
3.6	0.87	-64	0.32	-42		
3.7	0.85	-67	0.31	-42		
3.8	0.83	-71	0.30	-45		
3.9	0.83	-71	0.30	-43		
4	0.82	-73	0.29	-46		
4.1	0.83	-76	0.29	-45		
4.2	0.83	-79	0.28	-47		
4.3	0.84	-82	0.29	-48		
4.4	0.84	-85	0.27	-49		
4.5	0.84	-87	0.28	-50		
4.6	0.85	-91	0.26	-51		
4.7	0.84	-95	0.28	-52		
4.8	0.85	-97	0.25	-52		
4.9	0.85	-100	0.27	-54		
5	0.85	-103	0.25	-54		
5.1	0.86	-106	0.27	-57		
5.2	0.85	-108	0.25	-56		
5.3	0.84	-113	0.27	-58		
5.4	0.84	-115	0.25	-58		
5.5	0.84	-117	0.27	-61		
5.6	0.83	-121	0.25	-61		
5.7	0.83	-123	0.27	-64		
5.8	0.81	-125	0.25	-65		
5.9	0.81	-128	0.26	-67		
6	0.80	-130	0.24	-65		

IAM-91563 Applications Information

Introduction

The IAM-91563 is a miniature downconverter developed for use in superheterodyne receivers for commercial wireless applications with RF bands from 800 MHz to 6 GHz. Operating from only 3 volts, the IAM-91563 is an excellent choice for use in low current applications such as: 1.9 GHz Personal Communication Systems (PCS) & Personal Handy System (PHS), 2 GHz Digital European Cordless Telephone (DECT), and 800 MHz cellular telephones (e.g., GSM, NADC, JDC). Combined with Hewlett-Packard's other RFICs and discrete components housed in the same ultra-miniature SOT-363 package, the IAM-91563 also provides flexible, building-block solutions for WLAN's and wireless datacomm such as PCMCIA RF modems as well as many Industrial, Scientific and Medical (ISM) systems operating at 900 MHz, 2.5 GHz, and 5.8 GHz.

The IAM-91563 is a 3-port, downconverting RFIC mixer of the cascode (common source - common gate) type that uses a low level (-5 dBm) local oscillator (LO) to convert an RF signal in the 800 MHz to 6 GHz range to an IF between 50 and 700 MHz. The basic mixing function takes place in a cascode connected pair of FETs as shown in Figure 17.

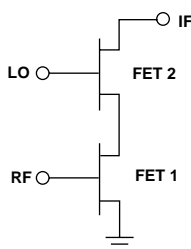

Figure 17. Cascode FET Mixer.

The received RF signal is connected to the gate of FET1 and the LO is applied to the gate of FET2. The purpose of FET2 is to vary the transconductance of FET1 over a highly nonlinear region at the rate of the LO frequency. This produces the nonlinearity required for frequency mixing to take place. This type of mixer is also known as a "transconductance mixer." The IF is taken from the drain of FET2.

An advantage of the cascode type of design is the inherent isolation between the gates of the two FETs which results in very good LO-to-RF isolation. An integrated buffer amplifier between the LO input and the gate of FET2 not only increases the LO-RF isolation but also reduces the amount of LO input power required by the mixer.

The IAM-91563 uses an innovative bias regulation circuit that realizes several benefits to the designer. First, the IAM-91563 operates with a single, positive device voltage from 1.5 to 5 volts with stable performance over a wide temperature range. Second, a unique feature of the IAM-91563 allows the device current to be easily increased by adding an external resistor to boost device current and increase linearity.

Using a minimum of external components with a standard bias of 3 volts/9 mA and LO power of -5 dBm, the IAM-91563 mixer achieves an RF to IF conversion gain of 9 dB at 1.9 GHz with a noise figure of 8.5 dB and an input third order intercept point of -6 dBm. LO-to-IF isolation is greater than 35 dB. Setting the bias for the higher linearity/higher current mode (approximately 16 mA) along with an LO drive

level of -2 dBm will boost the input IP_3 to approximately 0 dBm.

Test Circuit

The circuit shown in Figure 18 is used for 100% RF and DC testing. The test circuit is impedance matched for an RF of 1890 MHz and an IF of 250 MHz. The LO is set at 1640 MHz and -5 dBm for low side conversion. (High side conversion with an LO of 2240 MHz would produce similar performance.) The RF choke at the IF port is used to provide DC bias. Tests in this circuit are used to guarantee the G_{test} , NF_{test} , and Device Current (I_d) parameters shown in the table of Electrical Specifications.

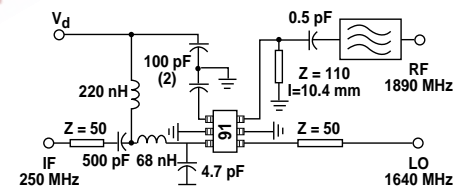

Figure 18. Test Circuit.

Specifications and Statistical Parameters

Several categories of parameters appear within this data sheet. Parameters may be described with values that are either "minimum or maximum," "typical," or "standard deviations."

The values for parameters are based on comprehensive product characterization data, in which automated measurements are made on a minimum of 500 parts taken from 3 non-consecutive process lots of semiconductor wafers. The data derived from product characterization tends to be normally distributed, e.g., fits the standard "bell curve."

Parameters considered to be the most important to system performance are bounded by *minimum*

or *maximum* values. For the IAM-91563, these parameters are: Conversion Gain (G_{test}), Noise Figure (NF_{test}), and Device Current (I_d). Each of these guaranteed parameters is 100% tested.

Values for most of the parameters in the table of Electrical Specifications that are described by *typical* data are the mathematical mean (μ), of the normal distribution taken from the characterization data. For parameters where measurements or mathematical averaging may not be practical, such as the Typical Reflection Coefficients table or performance curves, the data represents a nominal part taken from the “center” of the characterization distribution. Typical values are intended to be used as a basis for electrical design.

To assist designers in optimizing not only the immediate circuit using the IAM-91563, but to also optimize and evaluate trade-offs that affect a complete wireless system, the *standard deviation* (σ) is provided for many of the Electrical Specifications parameters (at 25°) in addition to the mean. The standard deviation is a measure of the variability about the mean. It will be recalled that a normal distribution is completely described by the mean and standard deviation.

Standard statistics tables or calculations provide the probability of a parameter falling between any two values, usually symmetrically located about the mean. Referring to Figure 12 for example, the probability of a parameter being between $\pm 1\sigma$ is 68.3%; between $\pm 2\sigma$ is 95.4%; and between $\pm 3\sigma$ is 99.7%.

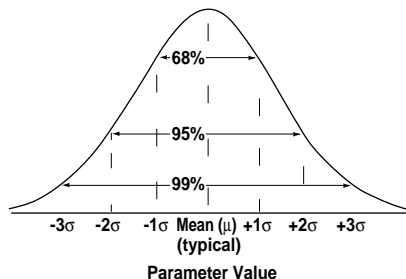

Figure 19. Normal Distribution.

Phase Reference Planes

The positions of the reference planes used to specify Reflection Coefficients for this device are shown in Figure 20. As seen in the illustration, the reference planes are located at the point where the package leads contact the test circuit.

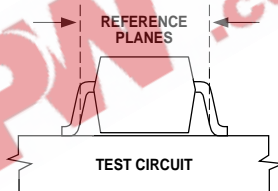

Figure 20. Phase Reference Planes.

RF Layout

An RF layout similar to the one in Figure 21 is suggested as a starting point for microstripline designs using the IAM-91563 mixer. This layout shows the capacitor for the Source Bypass pin and the optional resistor used to increase bias current. Adequate grounding is important to obtain maximum performance and to maintain stability. Both of the ground pins of the MMIC should be connected to the RF groundplane on the backside of the PCB by means of plated through holes (vias) that are placed near the package terminals. As a minimum, one via should be located next to each of the ground pins to ensure good RF grounding. It is a good practice to

use multiple vias to further minimize ground path inductance.

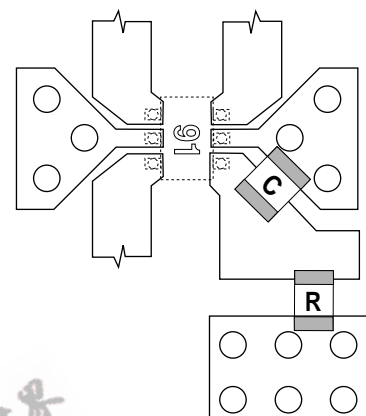

Figure 21. RFLayout.

It is recommended that the PCB pads for the ground pins *not* be connected together underneath the body of the package. PCB traces hidden under the package cannot be adequately inspected for SMT solder quality.

PCB Material

FR-4 or G-10 printed circuit board materials are a good choice for most low cost wireless applications. Typical board thickness is 0.020 to 0.031 inches. Thicknesses greater than 0.031 inch began to introduce excessive inductance in the ground vias. The width of the 50 Ω microstriplines on PC boards in this thickness range is also very convenient for mounting chip components such as the series inductor at the input or DC blocking and bypass capacitors.

For applications using higher frequencies such as the 5.8 GHz ISM band, the additional cost of PTFE/glass dielectric materials may be warranted to minimize transmission line loss at the mixer’s RF input. An additional consideration of using lower cost

materials at higher frequencies is the degradation in the Q's of transmission lines used for impedance matching.

Biasing

The IAM-91563 is a voltage-biased device and is designed to operate in the “normal mode” from a single, +3 volt power supply with a typical current drain of only 9 mA. The internal current regulation circuit allows the mixer to be operated with voltages as high as +5 volts or as low as +1.5 volt.

The device current can be increased up to 20 mA by adding an external resistor from the Source Bypass pin to ground. This feature makes it possible to operate the IAM-91563 in the “high power mode” to achieve greater linearity. Refer to the section titled “High Linearity Mode” for information on applications and performance when using this feature.

Application Guidelines

Several design considerations should be taken into account to ensure that maximum performance is obtained from the IAM-91563 downconverter. The RF and IF ports must be impedance matched at their respective frequencies to the circuits to which they are connected. This is typically 50 ohms when the mixer is used as a building block component in a 50-ohm system. These ports have been left untuned on the MMIC to allow the mixer to be used over a wide range of RF and IF bands. The LO port is already sufficiently well matched (less than 1 dB of mismatch loss) for most applications.

As with most mixers, appropriate filters must be placed at the RF port and IF port such as in

Figure 22. The filter in front of the RF port eliminates interference from the image frequency and the IF filter prevents RF and LO signal leakage into the IF signal processing circuitry.

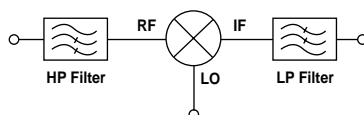

Figure 22. Image and IF Filters.

Additional design considerations relate to the use of higher bias current where greater linearity is required, bypassing of the Source Bypass pin, bias injection, and DC blocking and bypassing.

Each of these design factors will be discussed in greater detail in the following sections.

RF Port

A well matched RF port is especially important to maximize the conversion gain of the IAM-91563 mixer. Matching is also necessary to realize the specified noise figure and RF-to-LO isolation. The amount the conversion gain can be increased by impedance matching is equal to the mismatch loss at the RF port. The impedance of the RF port is characterized by the measured reflection coefficients shown in Typical Reflection Coefficients Table. The maximum “mismatch gain” that results from eliminating the mismatch loss is expressed in dB as a function of the reflection coefficient as:

$$G_{RF, mm} = 10 \log_{10} \left(\frac{1}{1 - |\Gamma_{RF}|^2} \right) \quad (1)$$

For wireless bands in the 800 MHz to 6 GHz range, the magnitude of the reflection coefficient of the RF port varies from 0.91 to 0.80, which corresponds to a mismatch gain of 7.6 to 4.4 dB.

The impedance of the RF port is capacitive, and for frequencies from 800 MHz to 2.4 GHz, falls very near the R=1 circle of a Smith chart. While these impedances could be easily matched to 50 ohms with a simple series inductor, it is advantageous to use a 2-element matching network of the series C, shunt L type as shown in Figure 23 instead. There are two main reasons for this choice. The first is to incorporate a high pass filter characteristic into the matching circuit. Second, the series C, shunt L combination will match the entire range of RF port impedances to 50 Ω. Most wireless communication bands are sufficiently narrow that a single (mid-band) frequency approach to impedance matching is adequate.

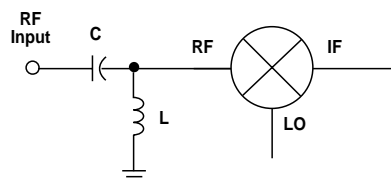

Figure 23. RF Input HPF Matching.

Impedance matching can be accomplished with lumped element components, transmission lines, or a combination of both. The use of surface mount inductors and capacitors is convenient for lower frequencies to minimize printed circuit board space. The use of high impedance transmission lines works well for higher frequencies where lumped element inductors may have excessive parasitics and/or self-resonances.

If other types of matching networks are used, it should be noted that while the RF input terminal of the IAM-91563 is at ground potential, it should not be used as a current sink. If the input is

connected directly to a preceding stage that has a voltage present, a DC blocking capacitor should be used.

IF port

The IAM-91563 can be used for downconversion to intermediate frequencies in the 50 to 700 MHz range. Similar to the RF port, the reflection coefficient at the IF is fairly high and Equation 1 can be used to predict a mismatch gain of up to 2.2 dB by impedance matching. A well matched IF port will also provide the optimum output power and LO-to-IF isolation. Reflection coefficients for the IF port are shown in the Typical Reflection Coefficients Table.

The IF port impedance matching network should be of the low pass filter type to reflect RF and LO power back into the mixer while allowing the IF to pass through. The shunt C, series L type of network in Figure 24 is a very practical choice that will meet the low pass filter requirement while matching any IF impedances over the 50 - 700 MHz range to 50 ohms.

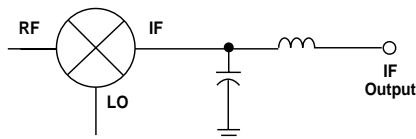

Figure 24. IF Output LPF Matching.

The DC bias is also applied to the mixer through the IF port. Figure 25 shows how an inductor (RFC) is used to isolate the IF from the DC supply. The bias line is bypassed to ground with a capacitor to keep RF off of the DC supply lines and to prevent dips or peaks in the response of the mixer.

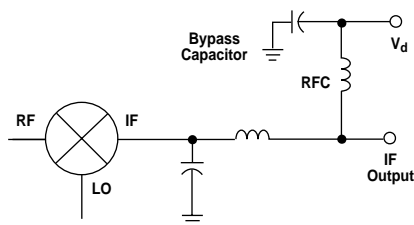

Figure 25. Bias Connection.

LO Port

The LO input port is internally matched to 50 Ω within a 2.2:1 VSWR over the entire operating frequency range. Additional matching will normally not be needed. However, if desired, a small series inductor can be used to provide some improvement in the LO match and thus reduce the LO drive level requirement by up to 0.7 dB. Reflection coefficients for the LO port are shown in the table of Typical Reflection Coefficients.

Source Bypass Pin

The Source Bypass pin should be RF bypassed to ground at both the RF and LO frequencies as well as the IF. Many capacitors with values large enough to adequately bypass lower intermediate frequencies contain parasitics that may have resonances in the RF band. It is often practical to use two capacitors in parallel for this purpose instead of one. A small value, high quality capacitor is used to bypass the RF/LO frequencies and a large value capacitor for the IF. When biased in the high linearity mode, a resistor is added from the Source Bypass pin to ground.

High Linearity Mode

The IAM-91563 has a feature that allows the user to place an external resistor from the Source Bypass pin to ground and increase the device current from a nominal

9 mA to as high as 20 mA. The additional current increases mixer linearity (IP_3) and output power (P_{1dB}). Mixer performance at higher device current is shown in Figures 26 and 27.

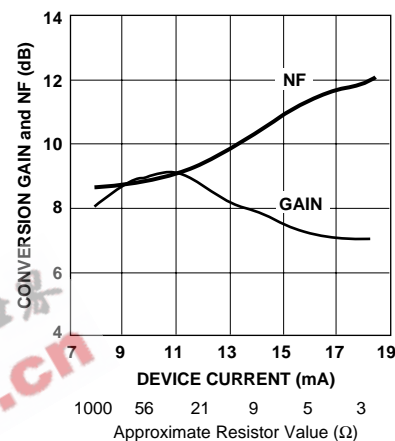

Figure 26. Available Conversion Gain and SSB Noise Figure vs. Device Current (Source Resistor).

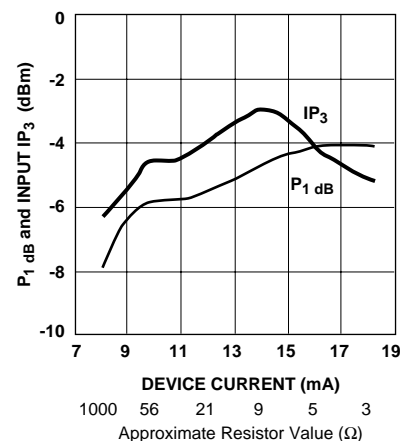

Figure 27. One dB Compression and Input Third Order Intercept Point vs. Device Current (Resistor).

As an example of improved linearity, the use of a 15 Ω resistor at the Source Bypass pin increases the device current to 14 mA. At 1.9 GHz, the input IP_3 is increased from -6.5 dBm to -3 dBm. Increasing the LO drive level from -5 dBm to -1 dBm further increases the input IP_3 to 0 dBm.

Application Example

The printed circuit layout in Figure 28 is a general purpose layout that will accommodate components for using the IAM-91563 for RF inputs from 800 MHz to 6 GHz. This layout is a microstripline design (solid groundplane on the backside of the circuit board) with 50 Ω interfaces for the RF input, IF output, and LO input. The circuit is fabricated on 0.031-inch thick FR-4 dielectric material. Plated through holes (vias) are used to bring the ground to the top side of the circuit where needed. Multiple vias are used to reduce the inductance of the paths to ground.

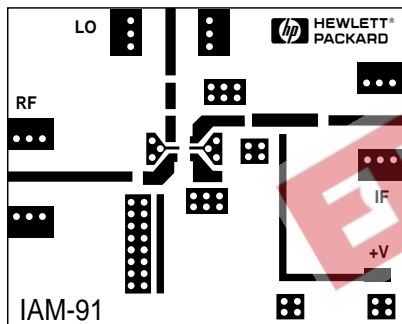

Figure 28. PCB Layout.

1.9 GHz Design Example

To illustrate a design approach for using the IAM-91563, a PCS band downconverter with an RF of 1.9 GHz and IF of 110 MHz is presented. The PCB layout above was used to assemble the mixer and verify performance.

A schematic diagram of the 1.9 GHz circuit is shown in Figure 29.

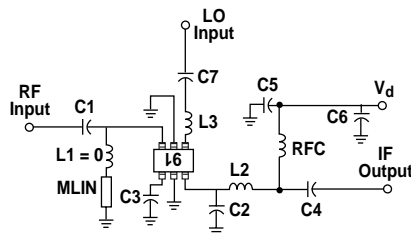

Figure 29. Schematic of Example Application Circuit.

At the RF input port, series capacitor C1 and transmission line MLIN form the input matching network and high pass filter. (Note: The PCB layout above has provision for an inductor, L1, in series with MLIN. Inductor L1 is not used in this design.)

Referring to the table of Reflection Coefficients, the RF input port $\Gamma_{RF} = 0.82 \angle -37^\circ$ at 1.9 GHz. This point is plotted as Point A on the Smith chart in Figure 30. For reasons previously discussed in the “RF Port” section above, a series C - shunt L network (from the 50 Ω source to Γ_{RF}) will be used to match Γ_{RF} to 50 Ω. Addition of a 6.5 nH shunt inductance moves the impedance trajectory from Point A to Point B. The match to 50 Ω is completed with a 0.6 pF series capacitance, C1, that moves the match to Point C, the center of the Smith chart.

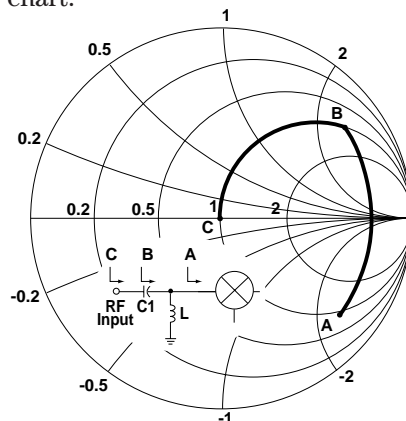

Figure 30. RF Input Impedance Match.

For this example, the shunt inductor was realized with the transmission line, MLIN in Figure 29 ($Z_0 = 90 \Omega$, length = 0.35 in.). A high quality capacitor should be selected for C1 to minimize the effects of the capacitor’s parasitic inductance and resistance. Series capacitor C1 also serves to block any DC that may be present at the output of the stage preceding the mixer.

At the IF output, the low pass filter and impedance match is formed by shunt capacitor C2 and series inductor L2. Referring again to the table of Reflection Coefficients, the IF output port $\Gamma_{IF} = 0.64 \angle -8^\circ$ at 100 MHz, which is the frequency point closest to the desired IF of 110 MHz. Γ_{IF} is plotted as Point A in Figure 31.

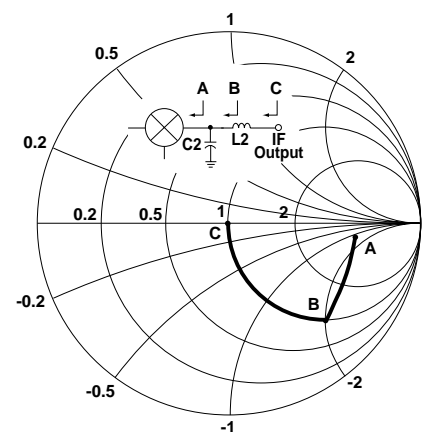

Figure 31. IF Input Impedance Match.

Adding a shunt capacitance (C2) of 11.3 pF brings the impedance to Point B. The match to Point C at the center of the chart is completed with a series inductance (L2) of 150 nH.

Although not necessary for many applications, the match at the LO port can be improved by the addition of series inductor L3 with a value of approximately 8 nH. Design information (Γ_{LO}) for matching the LO port is obtained

Designs for Other Frequencies

The same design methodology described above can be applied to other wireless frequency bands. Design examples and measurement results for the 900 MHz and 2.4 GHz bands are shown in Figures 33 and 34.

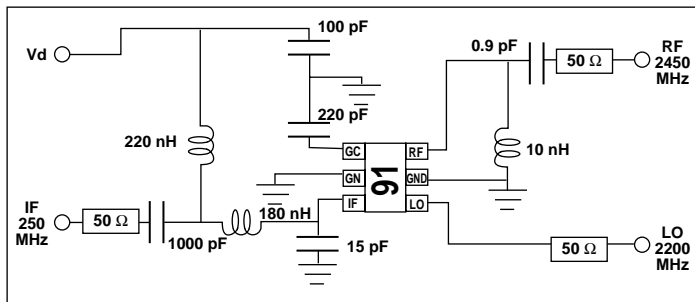

Measured results:

Conversion Gain = 10.6 dB
 SSB Noise Figure = 7.1 dB
 1 dB Compression = -7.0 dB
 P3 (Input) = -7 dBm

LO-RF Isolation = 21 dB
 LO-IF Isolation = 33 dB
 RF-IF Isolation = 17 dB

Operating conditions:

RF Frequency = 900 MHz
 IF Frequency = 80 MHz
 LO Frequency = 980 MHz

LO Drive Level = -5 dBm
 DC Power = 3.0V @ 9 mA

Figure 33. 800-900 MHz Cellular and ISM Band Mixer.

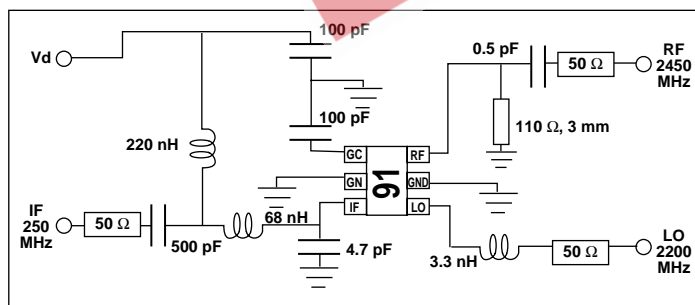

Measured results:

Conversion Gain = 7.7 dB
 SSB Noise Figure = 11 dB
 1 dB Compression = -8.7 dB
 IP3 (Input) = -7 dBm

LO-RF Isolation = 16 dB
 LO-IF Isolation = 35 dB
 RF-IF Isolation = 27 dB

Operating conditions:

RF Frequency = 2.45 GHz
 IF Frequency = 250 MHz
 LO Frequency = 2.2 GHz

LO Drive Level = -5 dBm
 DC Power = 3.0V @ 9 mA

Figure 34. 2.4 GHz ISM Band Mixer.

SOT-363 PCB Footprint

A recommended PCB pad layout for the miniature SOT-363 (SC-70) package used by the IAM-91563 is shown in Figure 35 (dimensions are in inches). This layout provides ample allowance for package placement by automated assembly equipment without adding parasitics that could impair the high frequency RF performance of the IAM-91563. The layout is shown with a nominal SOT-363 package footprint superimposed on the PCB pads.

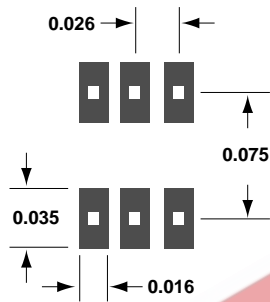

Figure 35. PCB Pad Layout (dimensions in inches).

SMT Assembly

Reliable assembly of surface mount components is a complex process that involves many material, process, and equipment factors, including: method of heating (e.g., IR or vapor phase reflow, wave soldering, etc.) circuit board material, conductor thickness and pattern, type of solder alloy, and the thermal conductivity and thermal mass of components. Components with a low mass, such as the SOT-363 package, will reach solder reflow temperatures faster than those with a greater mass.

The IAM-91563 is has been qualified to the time-temperature profile shown in Figure 36. This profile is representative of an IR reflow type of surface mount assembly process.

After ramping up from room temperature, the circuit board with components attached to it (held in place with solder paste)

passes through one or more preheat zones. The preheat zones increase the temperature of the board and components to prevent thermal shock and begin evaporating solvents from the solder paste. The reflow zone briefly elevates the temperature sufficiently to produce a reflow of the solder.

The rates of change of temperature for the ramp-up and cool-down zones are chosen to be low enough to not cause deformation of the board or damage to components due to thermal shock. The maximum temperature in the reflow zone (T_{MAX}) should not exceed 235 °C.

These parameters are typical for a surface mount assembly process for the IAM-91563. As a general guideline, the circuit board and components should be exposed only to the minimum temperatures and times necessary to achieve a uniform reflow of solder.

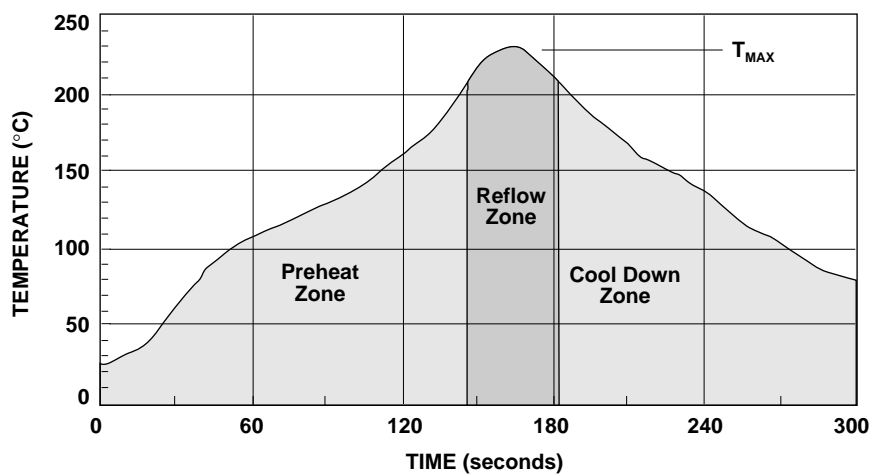

Figure 36. Surface Mount Assembly Profile.

Electrostatic Sensitivity

GaAs MMICs are electrostatic discharge (ESD) sensitive devices. Although the IAM-91563 is robust in design, permanent damage may occur to these devices if they are subjected to high energy electrostatic discharges. Electrostatic charges as high as several thousand volts (which readily accumulate on the human body and on test equipment) can discharge without detection and may result in degradation in performance or failure. The IAM-91563 is a ESD Class 1 device. Therefore, proper ESD precautions are recommended when handling, inspecting, and assembling these devices to avoid damage.



EEPW 电子产品世界 .com.cn

Package Dimensions
Outline 63 (SOT-363/SC-70)

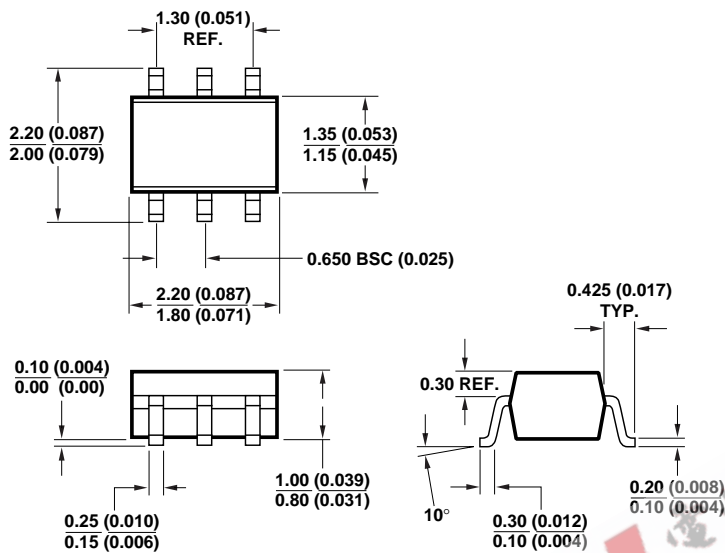

DIMENSIONS ARE IN MILLIMETERS (INCHES)

Part Number Ordering Information

Part Number	No. of Devices	Container
IAM-91563-TR1	3000	7" Reel
IAM-91563-BLK	100	antistatic bag

Device Orientation

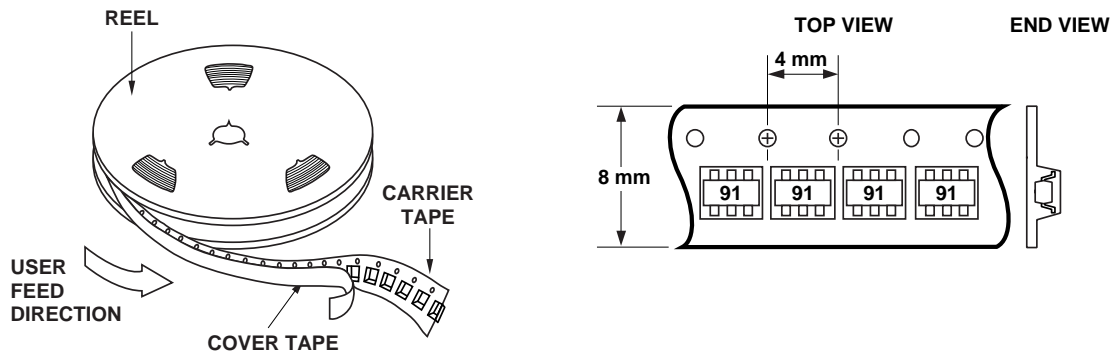

Tape Dimensions and Product Orientation For Outline 63

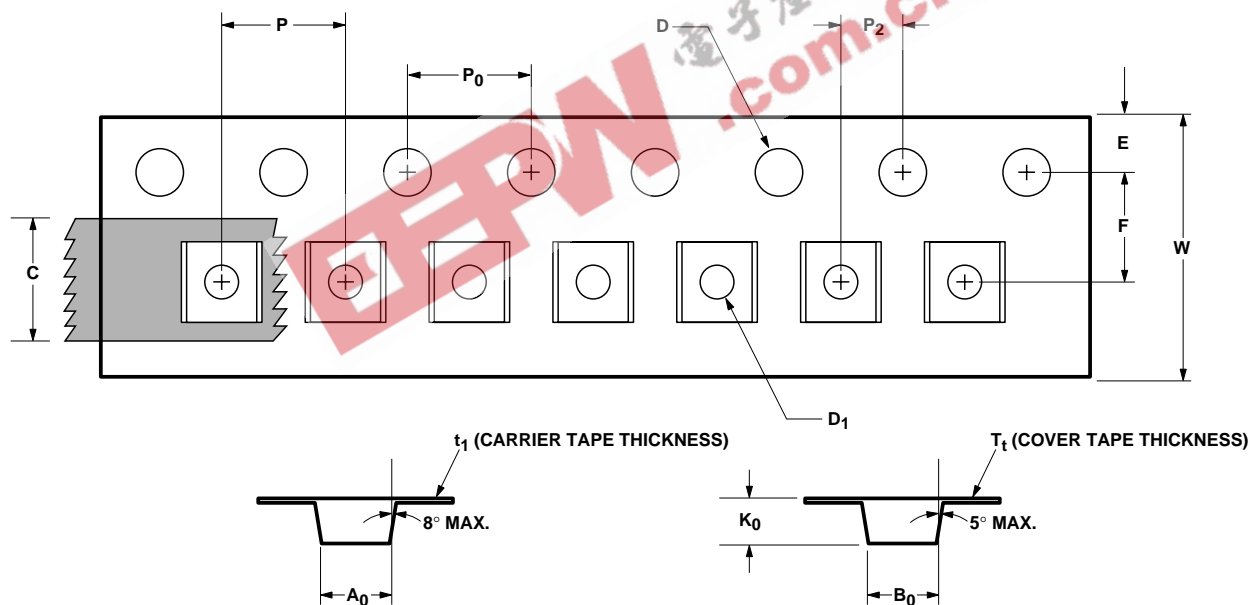

DESCRIPTION		SYMBOL	SIZE (mm)	SIZE (INCHES)
CAVITY	LENGTH	A ₀	2.24 ± 0.10	0.088 ± 0.004
	WIDTH	B ₀	2.34 ± 0.10	0.092 ± 0.004
	DEPTH	K ₀	1.22 ± 0.10	0.048 ± 0.004
	PITCH	P	4.00 ± 0.10	0.157 ± 0.004
	BOTTOM HOLE DIAMETER	D ₁	1.00 + 0.25	0.039 + 0.010
	PERFORATION	DIAMETER	D	1.55 ± 0.05
	PITCH	P ₀	4.00 ± 0.10	0.157 ± 0.004
	POSITION	E	1.75 ± 0.10	0.069 ± 0.004
CARRIER TAPE	WIDTH	W	8.00 ± 0.30	0.315 ± 0.012
	THICKNESS	t ₁	0.255 ± 0.013	0.010 ± 0.0005
COVER TAPE	WIDTH	C	5.4 ± 0.10	0.205 ± 0.004
	TAPE THICKNESS	T _t	0.062 ± 0.001	0.0025 ± 0.00004
DISTANCE	CAVITY TO PERFORATION (WIDTH DIRECTION)	F	3.50 ± 0.05	0.138 ± 0.002
	CAVITY TO PERFORATION (LENGTH DIRECTION)	P ₂	2.00 ± 0.05	0.079 ± 0.002