

MAIN FEATURES:

Symbol	Value	Unit
$I_{T(RMS)}$	0.8	A
V_{DRM}/V_{RRM}	400 and 600	V
I_{GT}	5 to 200	μA

DESCRIPTION

Thanks to highly sensitive triggering levels, the P01 SCR series is suitable for all applications where available gate current is limited, such as ground fault circuit interruptors, pilot circuits in solid state relays, stand-by mode power supplies, smoke and alarm detectors.

Available in through-hole or surface mount packages, the voltage capability of this series has been upgraded since its introduction, to reach 600 V.

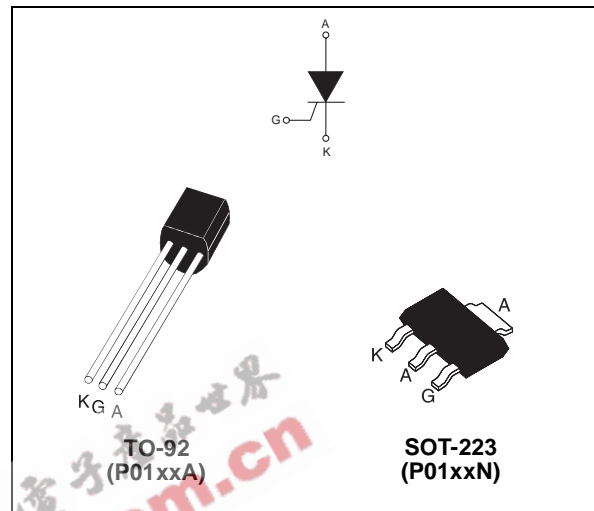
ABSOLUTE RATINGS (limiting values)

Symbol	Parameter			Value	Unit
$I_{T(RMS)}$	RMS on-state current (180° conduction angle)	TO-92	$T_I = 55^\circ C$	0.8	A
		SOT-223	$T_{amb} = 70^\circ C$		
$I_{T(AV)}$	Average on-state current (180° conduction angle)	TO-92	$T_I = 55^\circ C$	0.5	A
		SOT-223	$T_{amb} = 70^\circ C$		
I_{TSM}	Non repetitive surge peak on-state current	$t_p = 8.3 \text{ ms}$	$T_j = 25^\circ C$	8	A
		$t_p = 10 \text{ ms}$		7	
$I^2 t$	$I^2 t$ Value for fusing	$t_p = 10 \text{ ms}$	$T_j = 25^\circ C$	0.24	$A^2 s$
di/dt	Critical rate of rise of on-state current $I_G = 2 \times I_{GT}$, $t_r \leq 100 \text{ ns}$	$F = 60 \text{ Hz}$	$T_j = 125^\circ C$	50	$A/\mu s$
I_{GM}	Peak gate current	$t_p = 20 \mu s$	$T_j = 125^\circ C$	1	A
$P_{G(AV)}$	Average gate power dissipation		$T_j = 125^\circ C$	0.1	W
T_{stg} T_j	Storage junction temperature range Operating junction temperature range			- 40 to + 150 - 40 to + 125	$^\circ C$

P01 Series

ELECTRICAL CHARACTERISTICS (T_j = 25°C, unless otherwise specified)

Symbol	Test Conditions		P01xx			Unit		
			02	11	18			
I _{GT}	V _D = 12 V	R _L = 140 Ω	MIN.	-	4	0.5	μA	
			MAX.	200	25	5		
V _{GT}			MAX.	0.8		V		
V _{GD}	V _D = V _{DRM}	R _L = 3.3 kΩ	R _{GK} = 1 kΩ	T _j = 125°C	MIN.	0.1	V	
V _{RG}	I _{RG} = 10 μA		MIN.	8		V		
I _H	I _T = 50 mA		R _{GK} = 1 kΩ	MAX.	5		mA	
I _L	I _G = 1 mA		R _{GK} = 1 kΩ	MAX.	6		mA	
dV/dt	V _D = 67 % V _{DRM}	R _{GK} = 1 kΩ	T _j = 125°C	MIN.	75	80	75	V/μs
V _{TM}	I _{TM} = 1.6 A	tp = 380 μs	T _j = 25°C	MAX.	1.95		V	
V _{t0}	Threshold voltage		T _j = 125°C	MAX.	0.95		V	
R _d	Dynamic resistance		T _j = 125°C	MAX.	600		mΩ	
I _{DRM}	V _{DRM} = V _{RDM} = 400 V		R _{GK} = 1 kΩ	T _j = 25°C	MAX.		1	μA
	V _{DRM} = V _{RDM} = 600 V		R _{GK} = 1 kΩ				10	μA
	V _{DRM} = V _{RDM}		R _{GK} = 1 kΩ	T _j = 125°C	MAX.	100		μA

THERMAL RESISTANCES

Symbol	Parameter	Value	Unit	
R _{th(j-i)}	Junction to case (DC)	TO-92	80	°C/W
R _{th(j-t)}	Junction to tab (DC)	SOT-223	30	°C/W
R _{th(j-a)}	Junction to ambient	TO-92	150	
		S = 5 cm ²	SOT-223	

S = Copper surface under tab

PRODUCT SELECTOR

Part Number	Voltage		Sensitivity	Package
	400 V	600 V		
P0102DA	X		200 μA	TO-92
P0102DN	X		200 μA	SOT-223
P0102MA		X	200 μA	TO-92
P0102MN		X	200 μA	SOT-223
P0111DA	X		25 μA	TO-92
P0111DN	X		25 μA	SOT-223
P0111MA		X	25 μA	TO-92
P0111MN		X	25 μA	SOT-223
P0118DA	X		5 μA	TO-92
P0118DN	X		5 μA	SOT-223
P0118MA		X	5 μA	TO-92
P0118MN		X	5 μA	SOT-223

ORDERING INFORMATION

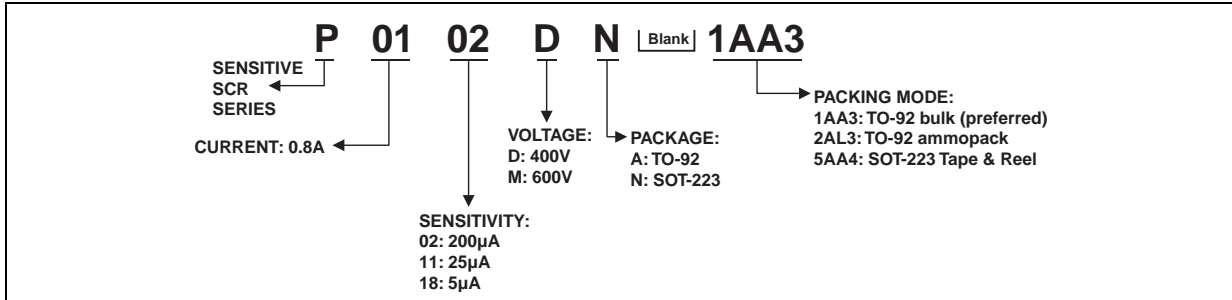

OTHER INFORMATION

Part Number	Marking	Weight	Base Quantity	Packing mode
P01xyA 1AA3	P01xyA	0.2 g	2500	Bulk
P01xyA 2AL3	P01xyA	0.2 g	2000	Ampmpack
P0102yN 5AA4	P2y	0.12 g	1000	Tape & reel
P0111yN 5AA4	P1y	0.12 g	1000	Tape & reel
P0118yN 5AA4	P8y	0.12 g	1000	Tape & reel

Note: xx = sensitivity, y = voltage

Fig. 1: Maximum average power dissipation versus average on-state current.

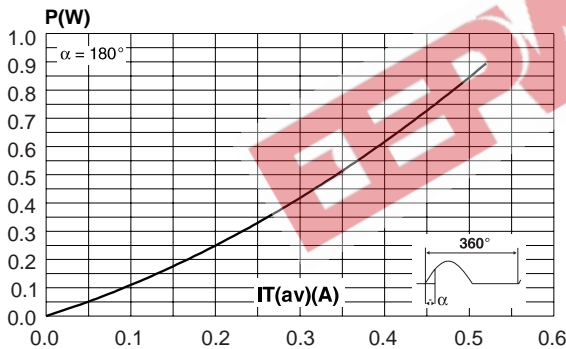

Fig. 2-2: Average and D.C. on-state current versus ambient temperature (device mounted on FR4 with recommended pad layout for SOT-223).

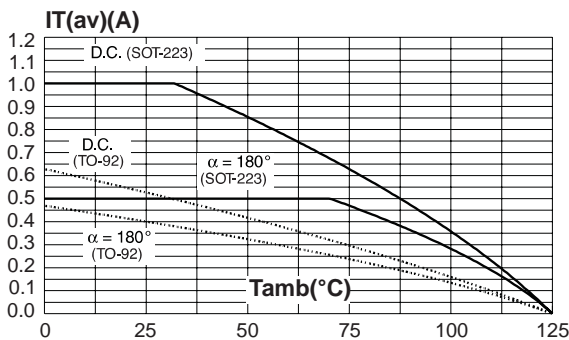

Fig. 2-1: Average and D.C. on-state current versus lead temperature.

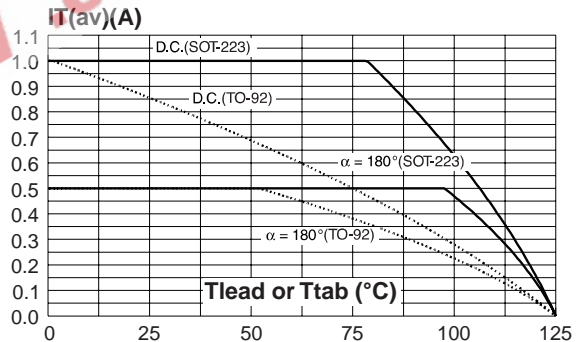

Fig. 3: Relative variation of thermal impedance junction to ambient versus pulse duration.

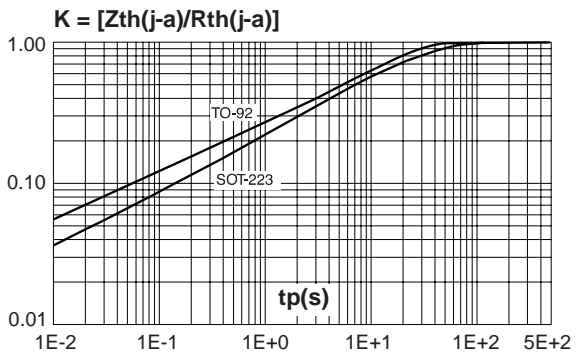

Fig. 4: Relative variation of gate trigger current, holding current and latching current versus junction temperature (typical values).

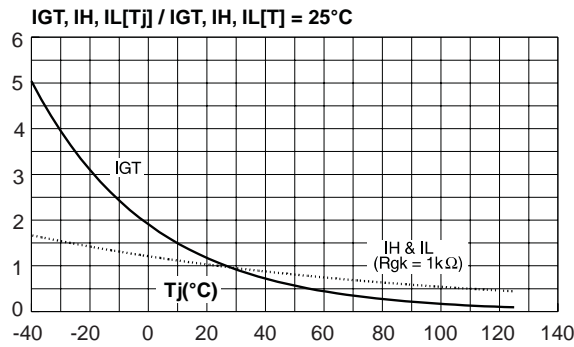

Fig. 6: Relative variation of dV/dt immunity versus gate-cathode resistance (typical values).

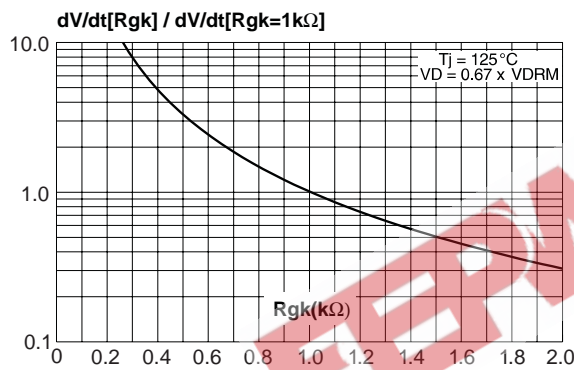

Fig. 8: Surge peak on-state current versus number of cycles.

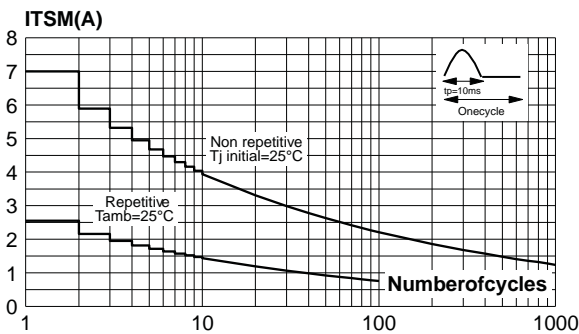

Fig. 5: Relative variation of holding current versus gate-cathode resistance (typical values).

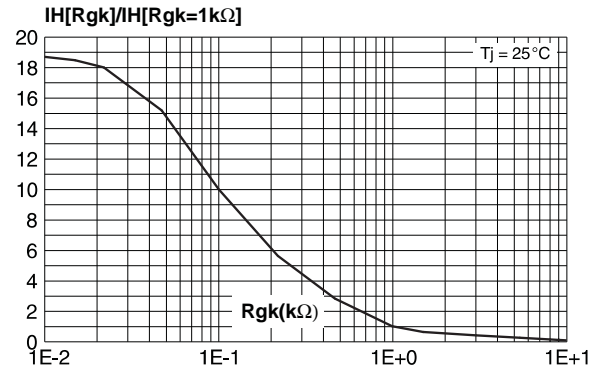

Fig. 7: Relative variation of dV/dt immunity versus gate-cathode capacitance (typical values).

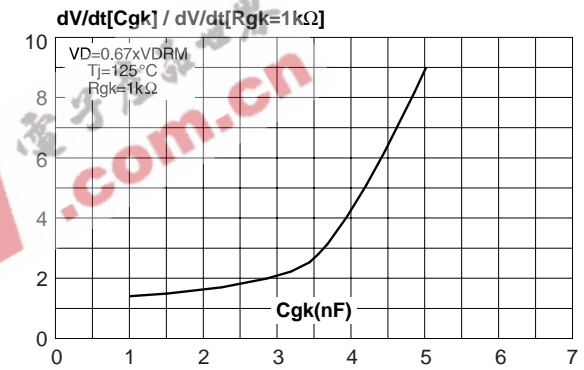

Fig. 9: Non-repetitive surge peak on-state current for a sinusoidal pulse with width tp < 10 ms, and corresponding value of I²t.

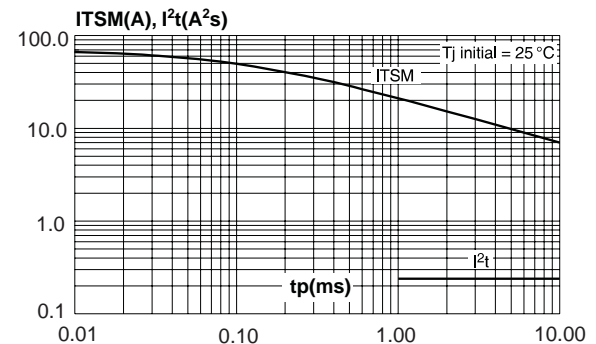

Fig. 10: On-state characteristics (maximum values).

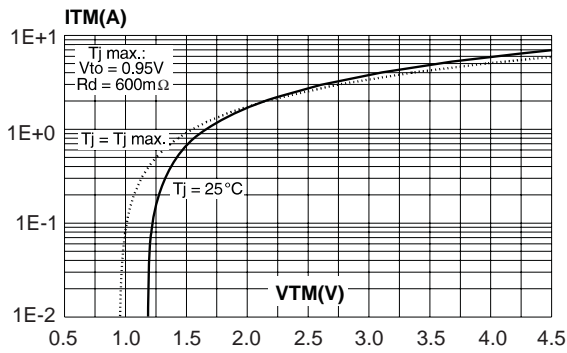
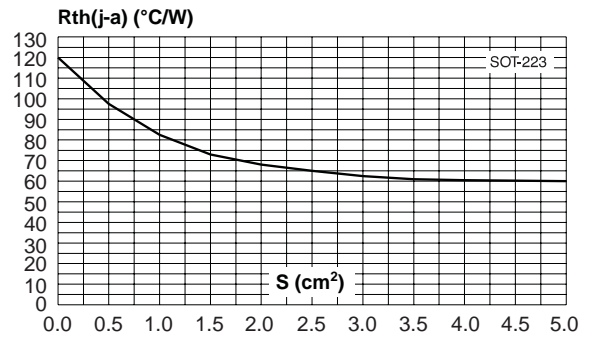

Fig. 11: SOT-223 Thermal resistance junction to ambient versus copper surface under tab (Epoxy printed circuit board FR4, copper thickness: 35 μm).



PACKAGE MECHANICAL DATA

TO-92 (Plastic)

REF.	DIMENSIONS					
	Millimeters			Inches		
	Min.	Typ.	Max.	Min.	Typ.	Max.
A		1.35			0.053	
B			4.70			0.185
C		2.54			0.100	
D	4.40			0.173		
E	12.70			0.500		
F			3.70			0.146
a			0.50			0.019

PACKAGE MECHANICAL DATA

SOT-223 (Plastic)

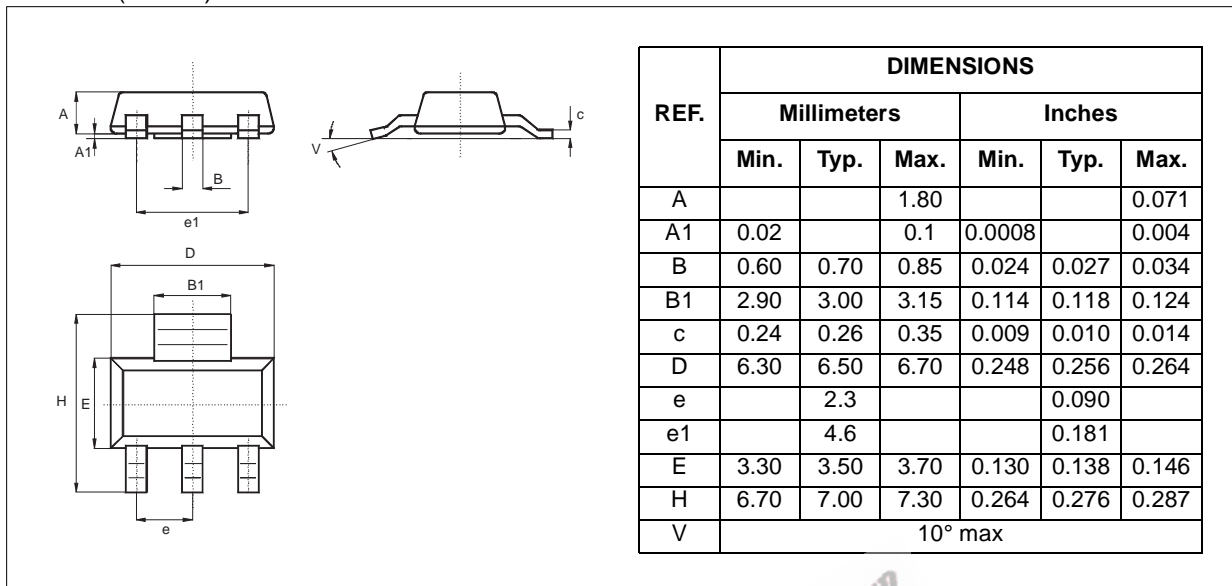

FOOTPRINT DIMENSIONS (in millimeters)

SOT-223 (Plastic)

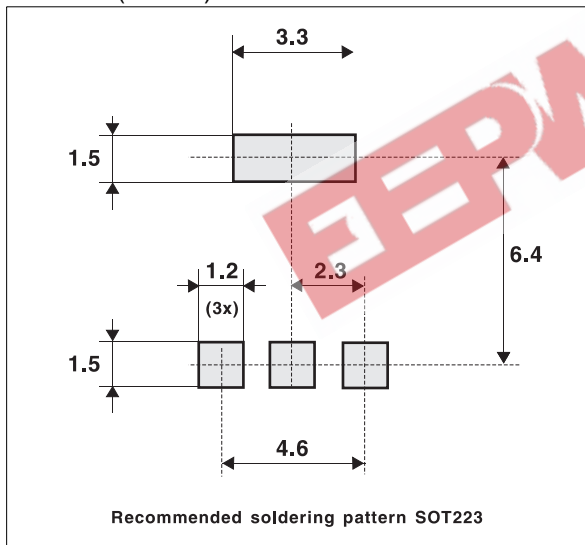

Information furnished is believed to be accurate and reliable. However, STMicroelectronics assumes no responsibility for the consequences of use of such information nor for any infringement of patents or other rights of third parties which may result from its use. No license is granted by implication or otherwise under any patent or patent rights of STMicroelectronics. Specifications mentioned in this publication are subject to change without notice. This publication supersedes and replaces all information previously supplied. STMicroelectronics products are not authorized for use as critical components in life support devices or systems without express written approval of STMicroelectronics.

© The ST logo is a registered trademark of STMicroelectronics

© 2000 STMicroelectronics - Printed in Italy - All Rights Reserved

STMicroelectronics GROUP OF COMPANIES
 Australia - Brazil - China - Finland - France - Germany - Hong Kong - India - Italy - Japan - Malaysia - Malta - Morocco
 Singapore - Spain - Sweden - Switzerland - United Kingdom