

CS2001

1.2 A Switching Regulator, and 5.0 V, 100 mA Linear Regulator with RESET

The CS2001 is a smart power supply ASIC utilized in automotive airbag systems. It contains a current-mode switching regulator with a 1.2 A on-chip switch and a 5.0 V, 100 mA linear regulator. The linear output capacitor must be 3.3 μ F or greater with an ESR in the range of 100 m Ω to 1.0 Ω . If the ESR of the cap is less than 100 m Ω , a series resistor must be used. The switcher can be configured in either a boost or flyback topology. The boost topology produces energy reserve voltage VER which is externally adjustable (25 V maximum) through the resistor divider connected to the V_{FB} pin. In the event of fault conditions that produce V_{FB} either open or shorted, the switcher is shut down.

Under normal operating conditions (V_{BAT} > 8.0 V), the current loading on the linear regulator is directed through V_{BAT}. A low battery or loss of battery condition switches the supply for the linear regulator from V_{BAT} to VER and shuts down the switcher using the ASIC's internal "smartswitch." This switchover feature minimizes the power dissipation in both the linear and switcher output devices and saves the cost of using a larger inductor.

The NERD (No Energy Reserve Detected) pin is a dual function output. If V_{OUT} is not in regulation, it provides a Power On Reset function whose time interval is externally adjustable with the capacitor. This interval can be seen on the RESETB pin, which allows for clean power-up and power-down of the microprocessor. Once V_{OUT} is in regulation, the logic level of the NERD output (usually low) indicates to the microprocessor whether or not the VER pin is connected.

A switched-capacitor voltage tripler accepts input voltage VER and produces output voltage V_{CHG} (typically VER + 8.0 V). This voltage is used in the system to drive high-side FETs.

This part is capable of withstanding a 50 V peak transient voltage. The linear regulator will not shut down during this event.

Features

- Linear Regulator 5.0 V \pm 2% @ 100 mA
- Switching Regulator 1.2 A Peak Internal Switch
- Voltage Tripler
- Smart Functions
 - Smartswitch
 - RESET
 - Energy Reserve Status
- Protection
 - Overtemperature
 - Current Limit
 - 50 V Peak Transient Capability
- Internally Fused Leads in SO-20L Package



ON Semiconductor™

<http://onsemi.com>

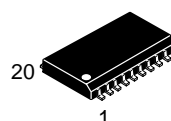

SO-20L
DWF SUFFIX
CASE 751D

MARKING DIAGRAM

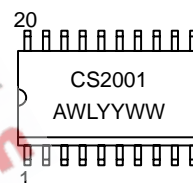

A = Assembly Location
WL, L = Wafer Lot
YY, Y = Year
WW, W = Work Week

PIN CONNECTIONS

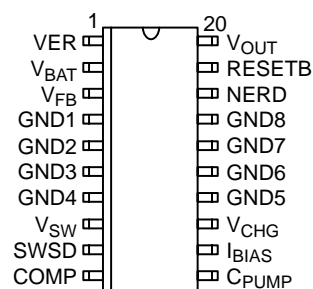

ORDERING INFORMATION

Device	Package	Shipping
CS2001YDWF20	SO-20L	37 Units/Rail
CS2001YDWFR20	SO-20L	1000 Tape & Reel

CS2001

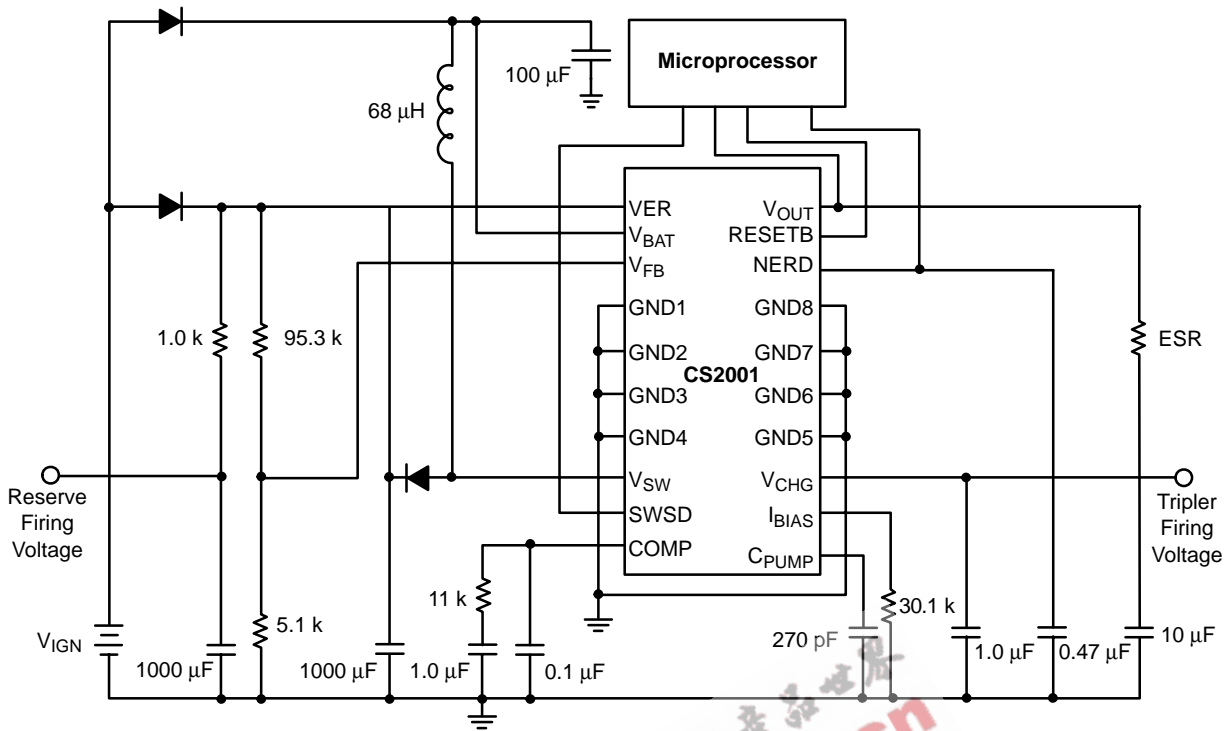

Figure 1. Application Diagram

ABSOLUTE MAXIMUM RATINGS*

Rating	Value	Unit	
V _{BAT}	-0.5 to 25	V	
VER	-0.5 to 25	V	
V _{OUT}	-0.5 to 7.0	V	
Digital Input/Output Voltage	-0.5 to 7.0	V	
Peak Transient Voltage (36 V Load Dump @ 14 V Battery Voltage)	50	V	
Storage Temperature Range	-55 to 150	°C	
Junction to Free Air Thermal Impedance	55	°C/W	
ESD Susceptibility (Human Body Model)	4.0	kV	
Lead Temperature Soldering:	Reflow: (SMD styles only) (Note 1.)	230 peak	°C
T _A	-40 to 85	°C	
T _J	-40 to 150	°C	

1. 60 second maximum above 183°C.

*The maximum package power dissipation must be observed.

CS2001

ELECTRICAL CHARACTERISTICS (8.0 V ≤ V_{BAT} ≤ 16 V, 8.0 V ≤ V_{ER} ≤ 25 V, 1.0 mA ≤ I_{V(OUT)} ≤ 100 mA, T_{TEST} = -40°C to 125°C; unless otherwise specified.)

Characteristic	Test Conditions	Min	Typ	Max	Unit
Linear Regulator					
Output Voltage	Output Driven from V _{BAT} , V _{ER} = 25 V Output Driven from V _{ER} , V _{BAT} = 0 V	4.9 4.9	- -	5.1 5.1	V V
Regulator Bias Current (from V _{BAT})	I _{V(BAT)} @ I _{V(OUT)} = -100 mA, SWSD = 4.0 V, V _{BAT} = 16 V, V _{ER} = 25 V T = -40°C T = 25°C T = 125°C	- - -	- - -	8.0 7.0 6.0	mA mA mA
Regulator Bias Current (from V _{ER})	I _{V(ER)} @ I _{V(OUT)} = -100 mA, SWSD = 4.0 V, V _{BAT} = 0 V, V _{ER} = 25 V T = -40°C T = 25°C T = 125°C	- - -	- - -	11 9.0 8.0	mA mA mA
Dropout Voltage V _{BAT} - V _{OUT}	V _{ER} = 25 V, I _{V(OUT)} = -100 mA (Probe Only)	-	-	1.5	V
Dropout Voltage V _{ER} - V _{OUT}	V _{BAT} = 0 V, I _{V(OUT)} = -100 mA	-	-	1.5	V
Smart Switch Threshold V _{BAT} to V _{ER}	V _{ER} = 25 V, I _{V(OUT)} = -50 mA	6.5	-	8.0	V
Smart Switch Threshold Hysteresis	V _{ER} = 25 V, I _{V(OUT)} = -50 mA	0.5	-	1.0	V
V _{OUT} Output Noise	V _{BAT} = 16 V, V _{ER} = 25 V, I _{V(OUT)} = -1.0 mA, C = 10 μF, ESR = 0.5 Ω	-	-	0.05	V
Line Regulation	-	-	-	0.025	V
Load Regulation	-	-	-	0.025	V
Output Current Limit	-	120	-	-	mA
Switching Regulator V _{ER} = 25V, I _{V(OUT)} = -1.0 mA					
Switching Frequency	C _{PUMP} 270 pF, R _{I(BIAS)} = 30.1 kΩ	135	150	165	kHz
Pump Drive Current	ΔI _{V(BAT)} for 0 A ≤ I _{V(SW)} ≤ 1.2 A	-	-	50	mA
Switch Saturation Voltage	I _{V(SW)} = 1.2 A	-	-	1.6	V
Output Current Limit	-	1.2	-	2.4	A
V _{FB} Regulation	-	1.238	1.27	1.303	V
V _{FB} Input Current	V _{FB} Above Short Low Detection Level	-	-	1.0	μA
V _{FB} Input Shorted Low Detection Level	-	200	250	300	mV
C _{PUMP} Short Detection Threshold	-	200	250	300	mV
Maximum Duty Cycle	-	80	-	95	%
V _{SW} Leakage Current	I _{V(SW)} @ V _{SW} = 50 V, SWSD = V _{OUT}	-	-	100	μA
Voltage Tripler V _{BAT} = 16 V, I _{V(OUT)} = -1.0 mA, C _{CHG} = 1.5 μF					
Output Voltage Clamp V _{CHG} - V _{ER}	V _{ER} = 8.0 V, I _{V(CHG)} = -30 μA V _{ER} = 12 V, I _{V(CHG)} = -90 μA	6.25 6.25	8.0 8.0	13 13	V V
Initial Charge Time	C _{CHG} = 0.15 μF, V _{ER} = 8.0 V, V _{CHG} = 14.25 V	-	-	30	ms
Maximum Output Voltage Clamp V _{CHG}	-	25	32.5	40	V
Output Voltage Clamp V _{CHG}	V _{ER} = 28 V, I _{V(CHG)} = 0 μA	25	32.5	40	V
Short Circuit Path Current Limit V _{ER} to V _{CHG}	-	-	-	3.0	mA

CS2001

ELECTRICAL CHARACTERISTICS (continued) ($8.0\text{ V} \leq V_{\text{BAT}} \leq 16\text{ V}$, $8.0\text{ V} \leq V_{\text{ER}} \leq 25\text{ V}$, $1.0\text{ mA} \leq I_{\text{V(OUT)}} \leq 100\text{ mA}$, $T_{\text{TEST}} = -40^{\circ}\text{C}$ to 125°C ; unless otherwise specified.)

Characteristic	Test Conditions	Min	Typ	Max	Unit
RESETB OUTPUT		$V_{\text{BAT}} = 0\text{ V}$			
High Threshold	V_{OUT} Increasing	4.525	4.75	4.85	V
Low Threshold	V_{OUT} Decreasing	4.5	4.65	4.825	V
Hysteresis	–	25	100	200	mV
Output Low Voltage	$V_{\text{OUT}} = 1.0\text{ V}$, $I_{\text{RESETB}} = 100\text{ }\mu\text{A}$ $I_{\text{RESETB}} = 1.0\text{ mA}$, $V_{\text{OUT}} = 4.5\text{ V}$	–	–	0.5	V
Pull-Up Resistor	RESETB = 1.0 V	25	50	100	k Ω
SWSD Input		$V_{\text{BAT}} = 16\text{ V}$, $V_{\text{ER}} = 25\text{ V}$, $I_{\text{V(OUT)}} = -1.0\text{ mA}$			
High Threshold	–	–	–	$0.7 \times V_{\text{OUT}}$	V
Low Threshold	–	$0.3 \times V_{\text{OUT}}$	–	–	V
Input Impedance	Referenced to Ground	10	20	40	k Ω
NERD OUTPUT		$V_{\text{BAT}} = 16\text{ V}$, $I_{\text{V(OUT)}} = -1.0\text{ mA}$, $C_{\text{NERD}} = 0.47\text{ }\mu\text{F}$			
VER Detection Voltage	–	1.5	–	6.5	V
Output Low Voltage	$I_{\text{NERD}} = 1.0\text{ mA}$, $V_{\text{OUT}} = 4.5\text{ V}$	–	–	0.5	V
Pull-Up Current	NERD = 0.5 V	30	40	50	μA
Power On Delay	–	6.25	8.5	11	ms
Clamping Voltage (Low)	VER Present	1.0	1.25	1.5	V
Clamping Voltage (High)	VER Not Present	3.5	3.75	4.0	V
General					
VER Load Current	$V_{\text{ER}} = 25\text{ V}$, $V_{\text{BAT}} = 16\text{ V}$, $I_{\text{V(OUT)}} = -100\text{ mA}$ $T = -40^{\circ}\text{C}$ $T = 25^{\circ}\text{C}$ $T = 125^{\circ}\text{C}$	–	–	5.0	mA
Thermal Shutdown	(Guaranteed by Design)	160	–	210	$^{\circ}\text{C}$

PACKAGE PIN DESCRIPTION

PACKAGE PIN #	PIN SYMBOL	FUNCTION
SO-20L		
1	VER	Energy reserve input.
2	V_{BAT}	Battery input.
3	V_{FB}	Charge PUMP control voltage input.
4	GND1	Ground.
5	GND2	Ground.
6	GND3	Ground.
7	GND4	Ground.
8	V_{SW}	Charge PUMP switch collector.
9	SWSD	Charge PUMP shutdown input.
10	COMP	Charge PUMP compensation pin.
11	C_{PUMP}	Charge PUMP timing cap input.
12	I_{BIAS}	Reference current resistor pin.

CS2001

PACKAGE PIN DESCRIPTION (continued)

PACKAGE PIN #		
SO-20L	PIN SYMBOL	FUNCTION
13	V _{CHG}	Switched cap voltage tripler output.
14	GND5	Ground.
15	GND6	Ground.
16	GND7	Ground.
17	GND8	Ground.
18	NERD	No energy reserve detected output.
19	RESETB	Reset output.
20	V _{OUT}	Linear regulator output.

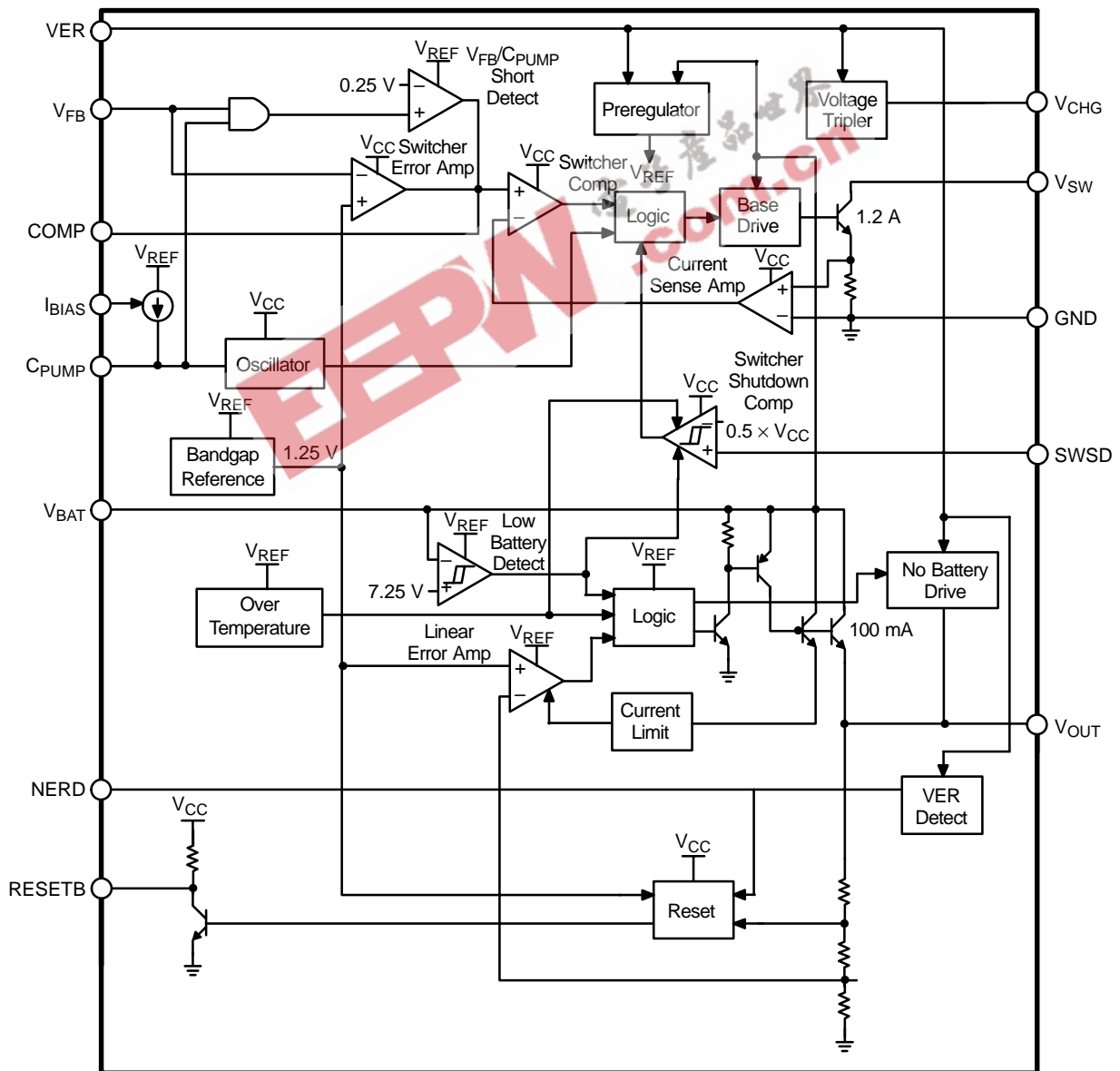

Figure 2. Block Diagram

CS2001

CIRCUIT DESCRIPTION

Figure 3 is an oscilloscope waveform showing the charge pump collector voltage, collector current and the charge pump timing capacitor during normal operation with $I_{VER} = 30\text{mA}$.

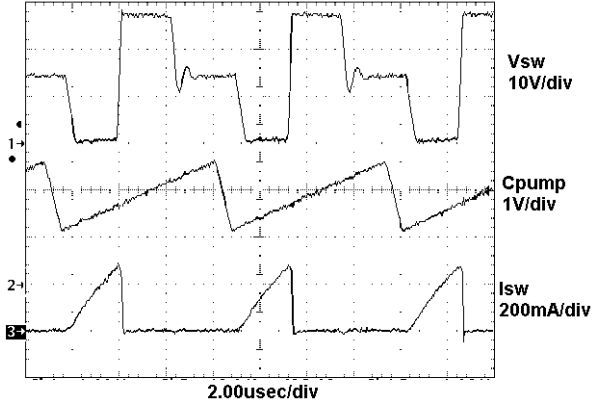

Figure 3. Typical Operation with $I_{VER} = 30\text{ mA}$

Figure 4 is an oscilloscope waveform showing the voltage tripler output and the energy reserve input during power up.

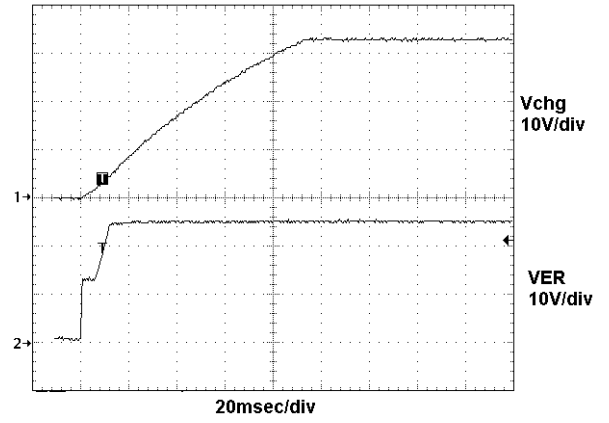

Figure 4. Startup with $R_{V(CHG)} = 510\text{ k}$

EEPW 电子产品世界 .com.cn

CS2001

PACKAGE DIMENSIONS

SO-20L
DWF SUFFIX
CASE 751D-05
ISSUE F

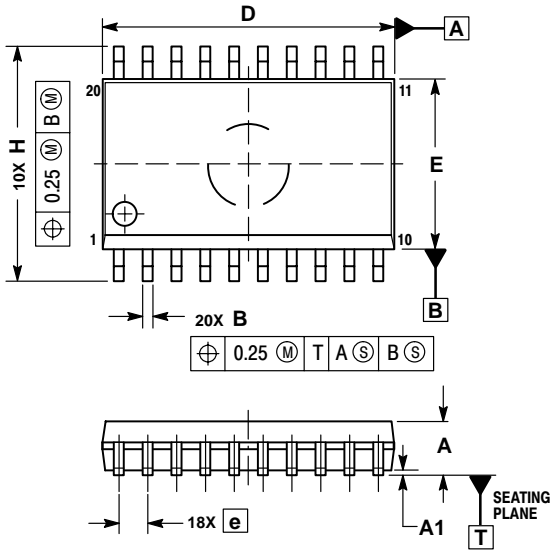

NOTES:

1. DIMENSIONS ARE IN MILLIMETERS.
2. INTERPRET DIMENSIONS AND TOLERANCES PER ASME Y14.5M, 1994.
3. DIMENSIONS D AND E DO NOT INCLUDE MOLD PROTRUSION.
4. MAXIMUM MOLD PROTRUSION 0.15 PER SIDE.
5. DIMENSION B DOES NOT INCLUDE DAMBAR PROTRUSION. ALLOWABLE PROTRUSION SHALL BE 0.13 TOTAL IN EXCESS OF B DIMENSION AT MAXIMUM MATERIAL CONDITION.

DIM	MILLIMETERS	
	MIN	MAX
A	2.35	2.65
A1	0.10	0.25
B	0.35	0.49
C	0.23	0.32
D	12.65	12.95
E	7.40	7.60
e	1.27 BSC	
H	10.05	10.55
h	0.25	0.75
L	0.50	0.90
θ	0°	7°

PACKAGE THERMAL DATA

Parameter		SO-20L	Unit
R _{θJC}	Typical	9	°C/W
R _{θJA}	Typical	55	°C/W

CS2001

EEPW 电子产品世界 .com.cn

ON Semiconductor and  are trademarks of Semiconductor Components Industries, LLC (SCILLC). SCILLC reserves the right to make changes without further notice to any products herein. SCILLC makes no warranty, representation or guarantee regarding the suitability of its products for any particular purpose, nor does SCILLC assume any liability arising out of the application or use of any product or circuit, and specifically disclaims any and all liability, including without limitation special, consequential or incidental damages. "Typical" parameters which may be provided in SCILLC data sheets and/or specifications can and do vary in different applications and actual performance may vary over time. All operating parameters, including "Typicals" must be validated for each customer application by customer's technical experts. SCILLC does not convey any license under its patent rights nor the rights of others. SCILLC products are not designed, intended, or authorized for use as components in systems intended for surgical implant into the body, or other applications intended to support or sustain life, or for any other application in which the failure of the SCILLC product could create a situation where personal injury or death may occur. Should Buyer purchase or use SCILLC products for any such unintended or unauthorized application, Buyer shall indemnify and hold SCILLC and its officers, employees, subsidiaries, affiliates, and distributors harmless against all claims, costs, damages, and expenses, and reasonable attorney fees arising out of, directly or indirectly, any claim of personal injury or death associated with such unintended or unauthorized use, even if such claim alleges that SCILLC was negligent regarding the design or manufacture of the part. SCILLC is an Equal Opportunity/Affirmative Action Employer.

PUBLICATION ORDERING INFORMATION

NORTH AMERICA Literature Fulfillment:

Literature Distribution Center for ON Semiconductor
P.O. Box 5163, Denver, Colorado 80217 USA
Phone: 303-675-2175 or 800-344-3860 Toll Free USA/Canada
Fax: 303-675-2176 or 800-344-3867 Toll Free USA/Canada
Email: ONlit@hibbertco.com
Fax Response Line: 303-675-2167 or 800-344-3810 Toll Free USA/Canada

N. American Technical Support: 800-282-9855 Toll Free USA/Canada

EUROPE: LDC for ON Semiconductor – European Support

German Phone: (+1) 303-308-7140 (Mon–Fri 2:30pm to 7:00pm CET)
Email: ONlit-german@hibbertco.com
French Phone: (+1) 303-308-7141 (Mon–Fri 2:00pm to 7:00pm CET)
Email: ONlit-french@hibbertco.com
English Phone: (+1) 303-308-7142 (Mon–Fri 12:00pm to 5:00pm GMT)
Email: ONlit@hibbertco.com

EUROPEAN TOLL-FREE ACCESS*: 00-800-4422-3781

*Available from Germany, France, Italy, UK, Ireland

CENTRAL/SOUTH AMERICA:

Spanish Phone: 303-308-7143 (Mon–Fri 8:00am to 5:00pm MST)
Email: ONlit-spanish@hibbertco.com

ASIA/PACIFIC: LDC for ON Semiconductor – Asia Support

Phone: 303-675-2121 (Tue–Fri 9:00am to 1:00pm, Hong Kong Time)
Toll Free from Hong Kong & Singapore:
001-800-4422-3781
Email: ONlit-asia@hibbertco.com

JAPAN: ON Semiconductor, Japan Customer Focus Center
4-32-1 Nishi-Gotanda, Shinagawa-ku, Tokyo, Japan 141-0031
Phone: 81-3-5740-2745
Email: r14525@onsemi.com

ON Semiconductor Website: <http://onsemi.com>

For additional information, please contact your local Sales Representative.