

## SS12 - S100

### Features

- Glass passivated junctions.
- High current capability, low  $V_F$ .
- For use in low voltage, high frequency inverters free wheeling, and polarity protection applications.

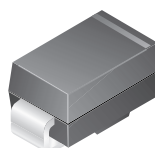

**SMA/DO-214AC**  
COLOR BAND DENOTES CATHODE

## 1.0 Ampere Schottky Barrier Rectifiers

### Absolute Maximum Ratings\*

$T_A = 25^\circ\text{C}$  unless otherwise noted

| Symbol          | Parameter  | Value       | Units                     |
|-----------------|--|-------------|---------------------------|
| $I_{F(AV)}$     | Average Rectified Current<br>.375" lead length @ $T_A = 75^\circ\text{C}$  | 1.0         | A                         |
| $I_{FSM}$       | Non-repetitive Peak Forward Surge Current<br>8.3 ms single half-sine-wave<br>Superimposed on rated load (JEDEC method) | 40          | A                         |
| $P_D$           | Total Device Dissipation<br>Derate above $25^\circ\text{C}$  | 1.1<br>11   | W<br>mW/ $^\circ\text{C}$ |
| $R_{\theta JA}$ | Thermal Resistance, Junction to Ambient **   | 88          | $^\circ\text{C}/\text{W}$ |
| $T_{stg}$       | Storage Temperature Range  | -65 to +150 | $^\circ\text{C}$          |
| $T_J$           | Operating Junction Temperature   | -65 to +125 | $^\circ\text{C}$          |

\*These ratings are limiting values above which the serviceability of any semiconductor device may be impaired.

\*\*Device mounted on FR-4 PCB 0.013 mm.

### Electrical Characteristics

$T_A = 25^\circ\text{C}$  unless otherwise noted

| Symbol    | Parameter   | Device    |    |     |    |     |    |    |     | Units    |
|-----------|---|-----------|----|-----|----|-----|----|----|-----|----------|
|           |   | 12        | 13 | 14  | 15 | 16  | 18 | 19 | 100 |          |
| $V_{RRM}$ | Maximum Repetitive Reverse Voltage  | 20        | 30 | 40  | 50 | 60  | 80 | 90 | 100 | V        |
| $V_{RMS}$ | Maximum RMS Voltage   | 14        | 21 | 28  | 35 | 42  | 56 | 64 | 71  | V        |
| $V_R$     | DC Reverse Voltage (Rated $V_R$ )   | 20        | 30 | 40  | 50 | 60  | 80 | 90 | 100 | V        |
| $I_{RM}$  | Maximum Instantaneous Reverse Current<br>$T_A = 25^\circ\text{C}$ (Note 1) @ rated $V_R$<br>$T_A = 100^\circ\text{C}$ | 0.2<br>10 |    |     |    |     |    |    |     | mA<br>mA |
| $V_{FM}$  | Maximum Instantaneous Forward Voltage @ 1.0 A   | 500       |    | 700 |    | 850 |    |    | mV  |          |

Note: Pulse Test: Pulse Width  $\leq 300 \mu\text{s}$ , Duty Cycle  $\leq 2.0\%$

# Schottky Barrier Rectifiers

(continued)

SS12-S100

## Typical Characteristics

Forward Current Derating Curve

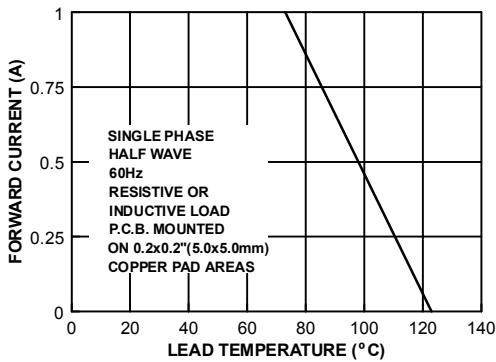

Forward Characteristics

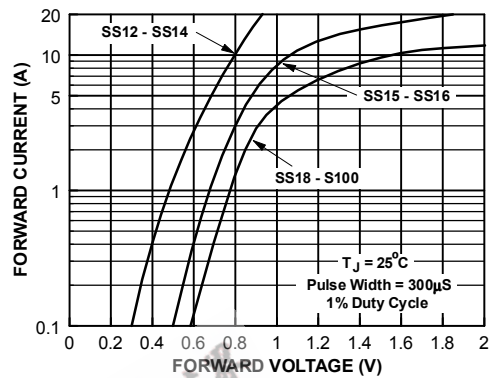

Non-Repetitive Surge Current

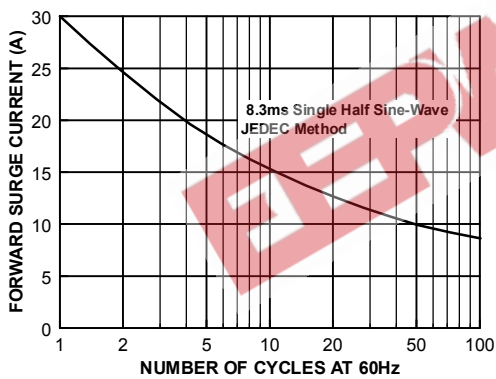

Junction Capacitance

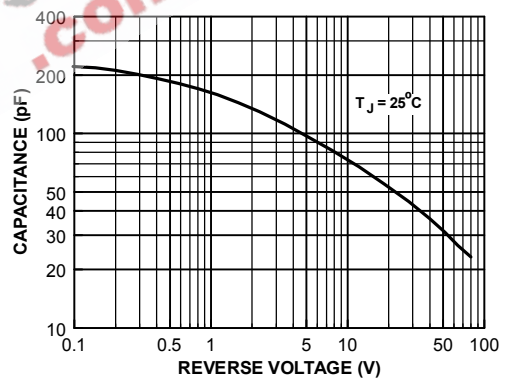

# DO-214AC(SMA) Tape and Reel Data



## DO-214AC(SMA) Packaging Configuration: Figure 1.0

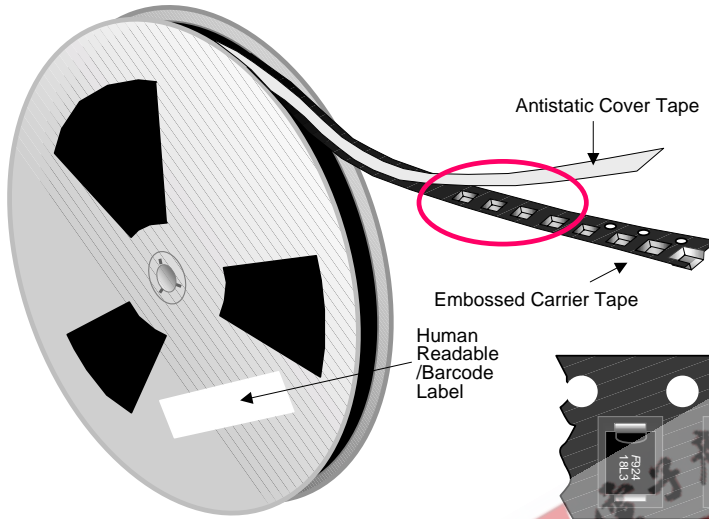

### Packaging Description:

DO-214AC(SMA) parts are shipped in tape. The carrier tape is made from a dissipative (carbon filled) polycarbonate resin. Alternate carrier tape is made of anti-static plastic. The cover tape is a multilayer film (Heat Activated Adhesive in nature) primarily composed of polyester film, adhesive layer, sealant, and anti-static sprayed agent. These reeled parts in standard option are shipped with 7,500 units per 13" or 330cm diameter reel. The reel comes in plastic or carton which is made of polystyrene plastic (anti-static coated) and thick white paper respectively. Further information is described in the Packaging Information table.

These full reels are individually labeled and placed inside a bleach box (illustrated in figure 1.0) made of recyclable carton paper with a Fairchild logo printing. One box contains two reels maximum. Certain number of these boxes are placed inside shipping box which comes in different sizes depending on the number of parts shipped.



DO-214AC(SMA) unit orientation

| DO-214AC(SMA) Packaging Information |                       |                       |
|-------------------------------------|-----------------------|-----------------------|
| Packaging Option                    | Under package code P5 | Under package code MA |
| Packaging type                      | TNR                   | TNR                   |
| Qty per Reel/Tube/Bag               | 7,500                 | 5,000                 |
| Reel Size (inch diameter)           | 13                    | 13                    |
| Box Dimension (mm)                  | 336X336X38            | 340X350X340           |
| Max qty per Box                     | 15,000                | 10,000                |
| Weight per unit (gm)                | 0.064                 | 0.064                 |
| Weight per Reel (kg)                | 0.860                 | 0.750                 |
| Note/Comments                       | Human readable label  | Barcode label         |

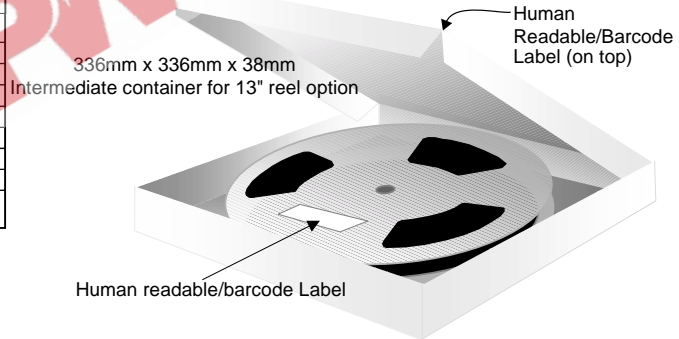

### Human Readable Label sample



### F63TNR Label sample



## DO-214AC(SMA) Tape Leader and Trailer Configuration: Figure 2.0

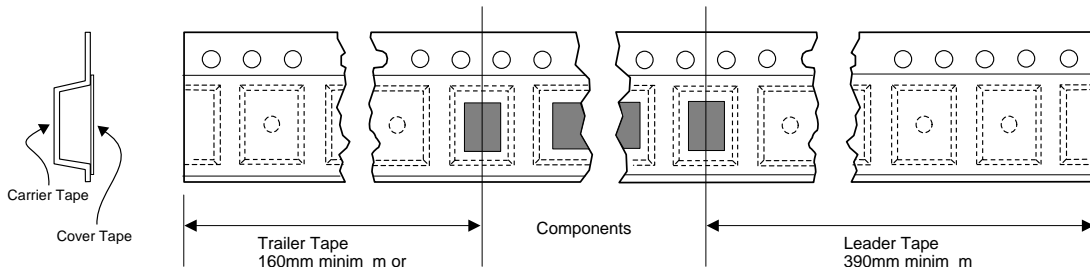

## DO-214AC(SMA) Tape and Reel Data, continued

### DO-214AC(SMA) Embossed Carrier Tape Configuration: Figure 3.0

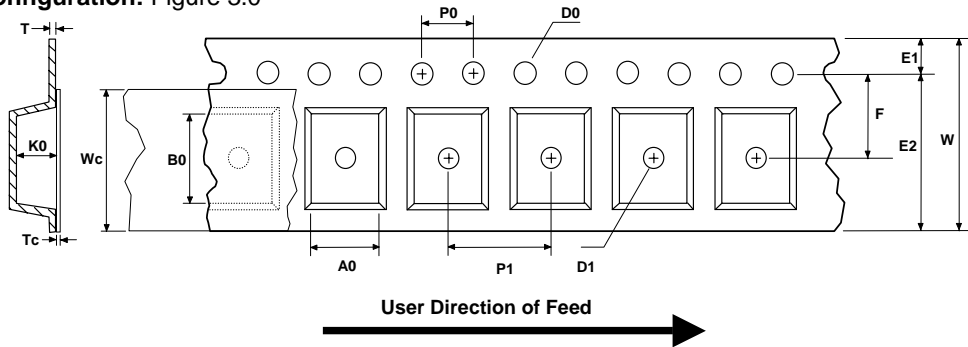

| Dimensions are in millimeter |                 |                 |                |                 |                   |                 |              |                |               |               |                 |                 |                 |                 |
|------------------------------|-----------------|-----------------|----------------|-----------------|-------------------|-----------------|--------------|----------------|---------------|---------------|-----------------|-----------------|-----------------|-----------------|
| Pkg type                     | A0              | B0              | W              | D0              | D1                | E1              | E2           | F              | P1            | P0            | K0              | T               | Wc              | Tc              |
| DO-214AC(SMA)<br>(12mm)      | 2.72<br>+/-0.10 | 5.25<br>+/-0.10 | 12.0<br>+/-0.3 | 1.55<br>+/-0.05 | 1.125<br>+/-0.125 | 1.75<br>+/-0.10 | 10.25<br>min | 5.5<br>+/-0.05 | 4.0<br>+/-0.1 | 4.0<br>+/-0.1 | 2.45<br>+/-0.10 | 0.23<br>+/-0.10 | 9.3<br>+/-0.025 | 0.06<br>+/-0.02 |

Notes: A0, B0, and K0 dimensions are determined with respect to the EIA/Jedec RS-481 rotational and lateral movement requirements (see sketches A, B, and C).

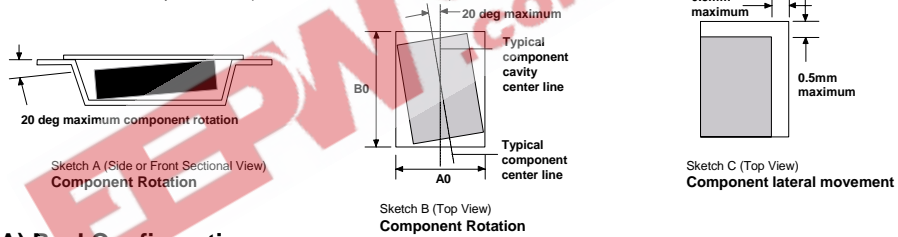

### DO-214AC(SMA) Reel Configuration: Figure 4.0

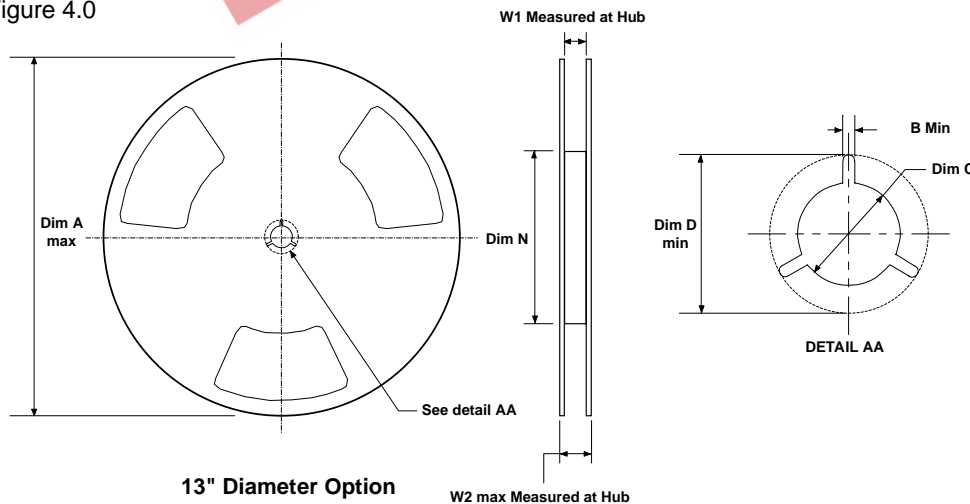

| Dimensions are in inches and millimeters |             |             |              |                                   |               |                |                                   |               |
|--|-------------|-------------|--------------|-----------------------------------|---------------|----------------|-----------------------------------|---------------|
| Tape Size                                | Reel Option | Dim A       | Dim B        | Dim C                             | Dim D         | Dim N          | Dim W1                            | Dim W2        |
| 12mm                                     | 13" Dia     | 13.0<br>330 | 0.059<br>1.5 | 512 +0.020/-0.008<br>13 +0.5/-0.2 | 0.795<br>20.2 | 1.97<br>50 min | 0.331 +0.059/-0.000<br>8.4 +1.5/0 | 0.567<br>14.4 |

# DO-214AC(SMA) Package Dimensions



## DO-214AC(SMA) (FS PKG Code P5)

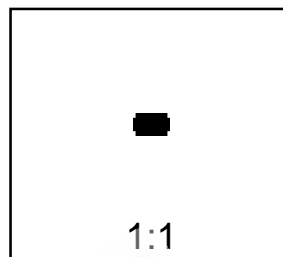
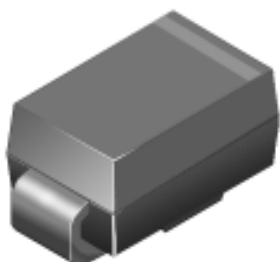

Scale 1:1 on letter size paper

Dimensions shown below are in:  
inches [millimeters]

Part Weight per unit (gram): 0.064

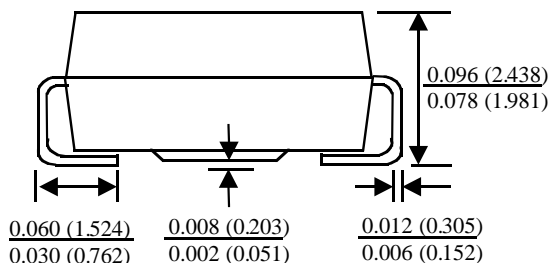
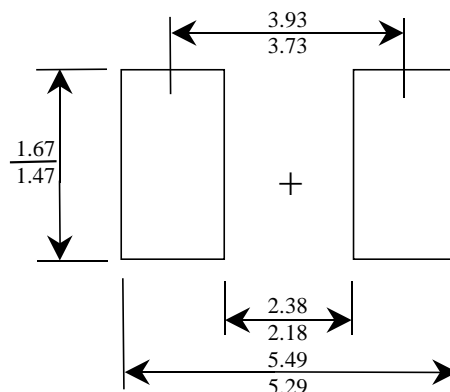
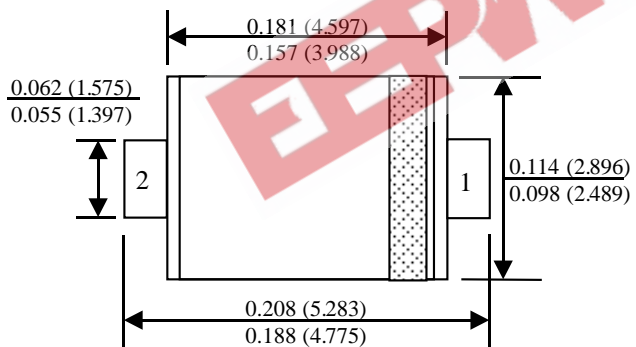

Minimum Recommended Land Pattern

## TRADEMARKS

The following are registered and unregistered trademarks Fairchild Semiconductor owns or is authorized to use and is not intended to be an exhaustive list of all such trademarks.

|                      |                     |                     |            |
|----------------------|---------------------|---------------------|------------|
| ACEx™                | FASTr™              | PowerTrench®        | SyncFET™   |
| Bottomless™          | GlobalOptoisolator™ | QFET™               | TinyLogic™ |
| CoolFET™             | GTO™                | QS™                 | UHC™       |
| CROSSVOLT™           | HiSeC™              | QT Optoelectronics™ | VCX™       |
| DOME™                | ISOPLANAR™          | Quiet Series™       |            |
| E <sup>2</sup> CMOS™ | MICROWIRE™          | SILENT SWITCHER®    |            |
| EnSigna™             | OPTOLOGIC™          | SMART START™        |            |
| FACT™                | OPTOPLANAR™         | SuperSOT™-3         |            |
| FACT Quiet Series™   | PACMAN™             | SuperSOT™-6         |            |
| FAST®                | POP™                | SuperSOT™-8         |            |

## DISCLAIMER

FAIRCHILD SEMICONDUCTOR RESERVES THE RIGHT TO MAKE CHANGES WITHOUT FURTHER NOTICE TO ANY PRODUCTS HEREIN TO IMPROVE RELIABILITY, FUNCTION OR DESIGN. FAIRCHILD DOES NOT ASSUME ANY LIABILITY ARISING OUT OF THE APPLICATION OR USE OF ANY PRODUCT OR CIRCUIT DESCRIBED HEREIN; NEITHER DOES IT CONVEY ANY LICENSE UNDER ITS PATENT RIGHTS, NOR THE RIGHTS OF OTHERS.

## LIFE SUPPORT POLICY

FAIRCHILD'S PRODUCTS ARE NOT AUTHORIZED FOR USE AS CRITICAL COMPONENTS IN LIFE SUPPORT DEVICES OR SYSTEMS WITHOUT THE EXPRESS WRITTEN APPROVAL OF FAIRCHILD SEMICONDUCTOR CORPORATION. As used herein:

1. Life support devices or systems are devices or systems which, (a) are intended for surgical implant into the body, or (b) support or sustain life, or (c) whose failure to perform when properly used in accordance with instructions for use provided in the labeling, can be reasonably expected to result in significant injury to the user.
2. A critical component is any component of a life support device or system whose failure to perform can be reasonably expected to cause the failure of the life support device or system, or to affect its safety or effectiveness.

## PRODUCT STATUS DEFINITIONS

### Definition of Terms

| Datasheet Identification | Product Status         | Definition  |
|--------------------------|------------------------|---|
| Advance Information      | Formative or In Design | This datasheet contains the design specifications for product development. Specifications may change in any manner without notice.  |
| Preliminary              | First Production       | This datasheet contains preliminary data, and supplementary data will be published at a later date. Fairchild Semiconductor reserves the right to make changes at any time without notice in order to improve design. |
| No Identification Needed | Full Production        | This datasheet contains final specifications. Fairchild Semiconductor reserves the right to make changes at any time without notice in order to improve design.   |
| Obsolete                 | Not In Production      | This datasheet contains specifications on a product that has been discontinued by Fairchild semiconductor. The datasheet is printed for reference information only.   |