



STD38NH02L STD38NH02L-1

N-channel 24V - 0.011Ω - 38A - DPAK/IPAK
STripFET™ III Power MOSFET

General features

| Type | V _{DSS} | R _{DS(on)} | I _D |
|--------------|------------------|---------------------|----------------|
| STD38NH02L-1 | 24V | <0.0135Ω | 38A |
| STD38NH02L | 24V | <0.0135Ω | 38A |

- Logic level device
- R_{DS(ON)} * Q_g Industry's benchmark
- Conduction losses reduced
- Switching losses reduced
- Low threshold drive

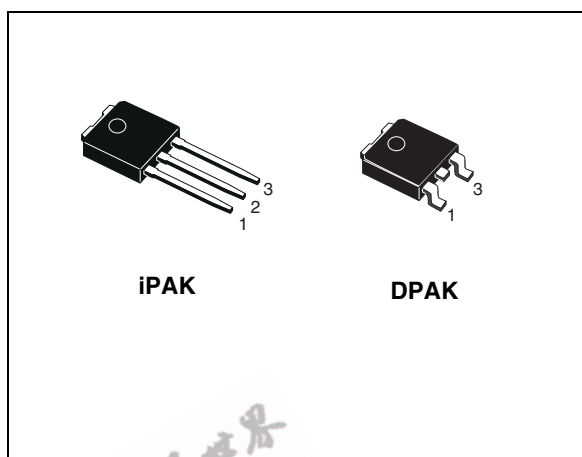

Description

This device utilizes the latest advanced design rules of ST's proprietary STripFET™ technology. This is suitable for the most demanding DC-DC converter application where high efficiency is to be achieved.

Applications

- Switching application

Internal schematic diagram

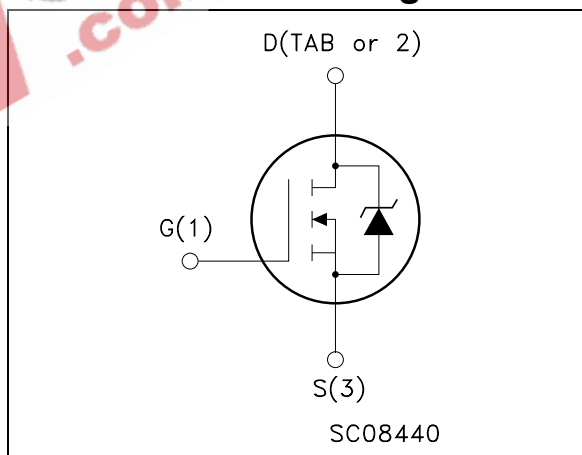

Order codes

| Part number | Marking | Package | Packaging |
|--------------|----------|---------|-------------|
| STD38NH02L-1 | D38NH02L | IPAK | Tube |
| STD38NH02LT4 | D38NH02L | DPAK | Tape & reel |

Contents

| | | |
|-----|---|----|
| 1 | Electrical ratings | 3 |
| 2 | Electrical characteristics | 4 |
| 2.1 | Electrical characteristics (curves) | 6 |
| 3 | Test circuit | 8 |
| 4 | Appendix A | 9 |
| 5 | Package mechanical data | 11 |
| 6 | Packing mechanical data | 14 |
| 7 | Revision history | 15 |



1 Electrical ratings

Table 1. Absolute maximum ratings

| Symbol | Parameter | Value | Unit |
|--------------------------|--|------------|-----------------------|
| $V_{\text{spike}}^{(1)}$ | Drain-source voltage rating | 30 | V |
| V_{DS} | Drain-source voltage ($V_{\text{GS}} = 0$) | 24 | V |
| V_{DGR} | Drain-gate voltage ($R_{\text{GS}} = 20 \text{ k}\Omega$) | 24 | V |
| V_{GS} | Gate- source voltage | ± 20 | V |
| I_{D} | Drain current (continuous) at $T_{\text{C}} = 25^{\circ}\text{C}$ | 38 | A |
| I_{D} | Drain current (continuous) at $T_{\text{C}} = 100^{\circ}\text{C}$ | 27 | A |
| $I_{\text{DM}}^{(2)}$ | Drain current (pulsed) | 152 | A |
| P_{tot} | Total dissipation at $T_{\text{C}} = 25^{\circ}\text{C}$ | 40 | W |
| | Derating Factor | 0.27 | W/ $^{\circ}\text{C}$ |
| $E_{\text{AS}}^{(3)}$ | Single pulse avalanche energy | 250 | mJ |
| T_{stg} | Storage temperature | -55 to 175 | $^{\circ}\text{C}$ |
| T_{j} | Max. operating junction temperature | | |

1. Guaranteed when external $R_{\text{g}}=4.7 \Omega$ and $t_{\text{f}} < t_{\text{fmax}}$.

2. Pulse width limited by safe operating area.

3. Starting $T_{\text{j}} = 25^{\circ}\text{C}$, $I_{\text{D}} = 19\text{A}$, $V_{\text{DD}} = 18\text{V}$

Table 2. Thermal data

| | | | |
|-----------------------|--|------|-----------------------------|
| $R_{\text{thj-case}}$ | Thermal resistance junction-case max | 3.75 | $^{\circ}\text{C}/\text{W}$ |
| $R_{\text{thj-amb}}$ | Thermal resistance junction-ambient max | 100 | $^{\circ}\text{C}/\text{W}$ |
| T_{J} | Maximum lead temperature for soldering purpose | 275 | $^{\circ}\text{C}$ |

2 Electrical characteristics

($T_{CASE}=25^{\circ}C$ unless otherwise specified)

Table 3. On/off states

| Symbol | Parameter | Test conditions | Min. | Typ. | Max. | Unit |
|---------------|--|--|------|----------------|-----------------|----------------------|
| $V_{(BR)DSS}$ | Drain-source breakdown voltage | $I_D = 25mA, V_{GS} = 0$ | 24 | | | V |
| I_{DSS} | Zero gate voltage drain current ($V_{GS} = 0$) | $V_{DS} = 20V$ $V_{DS} = 20V, T_C = 125^{\circ}C$ | | | 1 10 | μA μA |
| I_{GSS} | Gate-body leakage current ($V_{DS} = 0$) | $V_{GS} = \pm 20V$ | | | ± 100 | nA |
| $V_{GS(th)}$ | Gate threshold voltage | $V_{DS} = V_{GS}, I_D = 250\mu A$ | 1 | 1.8 | 2.5 | V |
| $R_{DS(on)}$ | Static drain-source on resistance | $V_{GS} = 10V, I_D = 19A$ $V_{GS} = 5V, I_D = 9.5A$ | | 0.011 0.015 | 0.0135 0.025 | Ω Ω |

Table 4. Dynamic

| Symbol | Parameter | Test conditions | Min. | Typ. | Max. | Unit |
|---|---|--|------|---------------------|------|----------------------|
| $g_{fs}^{(1)}$ | Forward transconductance | $V_{DS} = 10V, I_D = 19A$ | | 19 | | S |
| C_{iss} C_{oss} C_{rss} | Input capacitance Output capacitance Reverse transfer capacitance | $V_{DS} = 25V, f = 1MHz,$ $V_{GS} = 0$ | | 1070 305 45 | | pF pF pF |
| R_G | Gate Input Resistance | f = 1 MHz Gate DC Bias = 0 Test Signal Level = 20 mV Open Drain | | 1 | | Ω |
| $t_{d(on)}$ t_r $t_{d(off)}$ t_f | Turn-on delay time Rise time Turn-off delay time Fall time | $V_{DD} = 10V, I_D = 19A$ $R_G = 4.7\Omega, V_{GS} = 10V$ (see Figure 13) | | 7 62 25 12 | | ns ns ns ns |
| Q_g Q_{gs} Q_{gd} | Total gate charge Gate-source charge Gate-drain charge | $0.44V \leq V_{DD} \leq 10V,$ $I_D = 38A,$ $V_{GS} = 10V, R_G = 4.7\Omega$ (see Figure 14) | | 18 4 2.5 | 24 | nC nC nC |
| $Q_{oss}^{(2)}$ | Output charge | $V_{DS} = 16V, V_{GS} = 0V$ | | 6.5 | | nC |

1. Pulsed: Pulse duration = 300 μs , duty cycle 1.5 %.

2. $Q_{oss} = C_{oss} \cdot \Delta V_{in}$, $C_{oss} = C_{gd} + C_{ds}$. See [Chapter 4: Appendix A](#)

Table 5. Source drain diode

| Symbol | Parameter | Test conditions | Min. | Typ. | Max. | Unit |
|-----------------------------------|--|--|------|-----------------|-----------|---------------|
| I_{SD} $I_{SDM}^{(1)}$ | Source-drain current Source-drain current (pulsed) | | | | 38 152 | A A |
| $V_{SD}^{(2)}$ | Forward on voltage | $I_{SD} = 19A, V_{GS} = 0$ | | | 1.3 | V |
| t_{rr} Q_{rr} I_{RRM} | Reverse recovery time Reverse recovery charge Reverse recovery current | $I_{SD} = 38A, di/dt = 100A/\mu s,$ $V_{DD} = 18V, T_j = 150^\circ C$ (see Figure 15) | | 27 22 1.6 | | ns nC A |

1. Pulse width limited by safe operating area.
2. Pulsed: Pulse duration = 300 μs , duty cycle 1.5 %

EEPW 电子产品世界
.com.cn

2.1 Electrical characteristics (curves)

Figure 1. Safe operating area

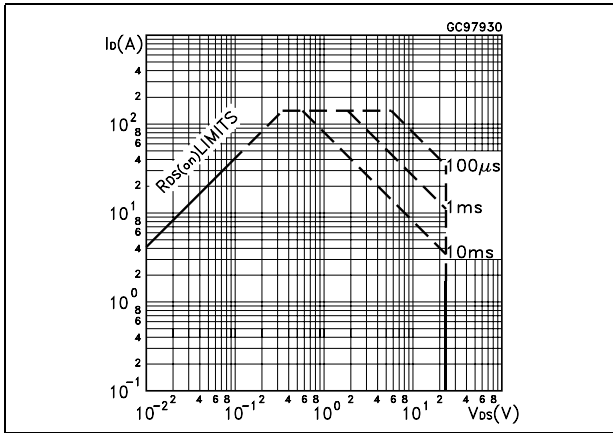

Figure 2. Thermal impedance

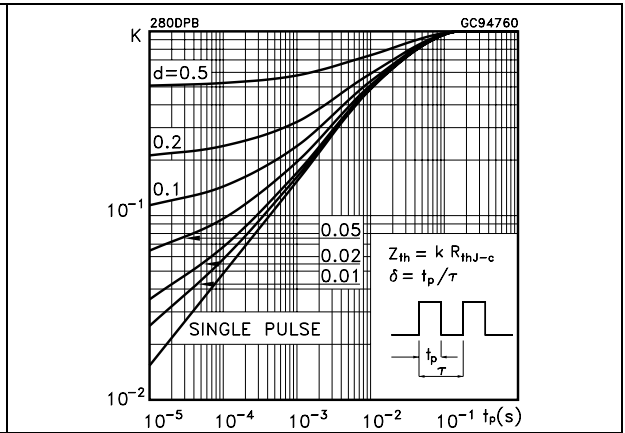

Figure 3. Output characteristics

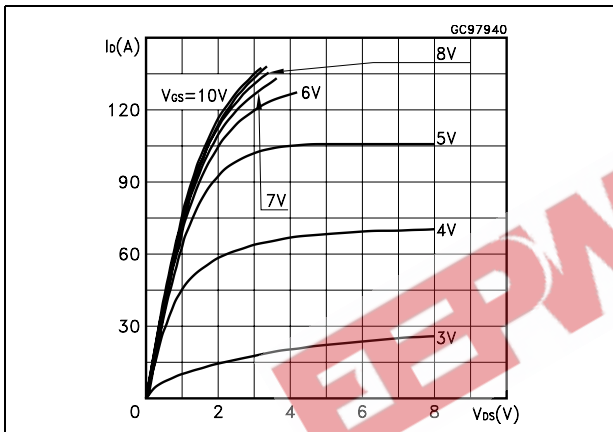

Figure 4. Transfer characteristics

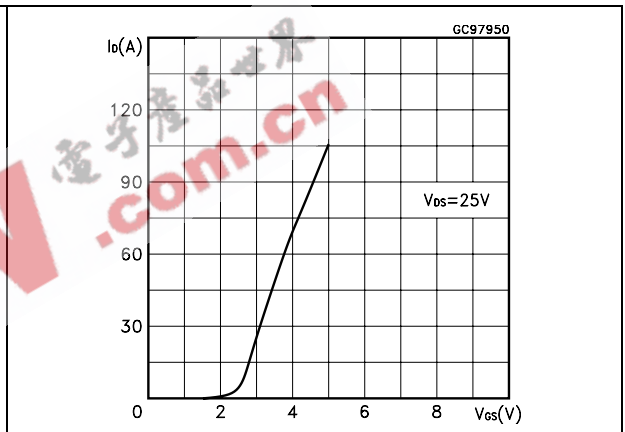

Figure 5. Transconductance

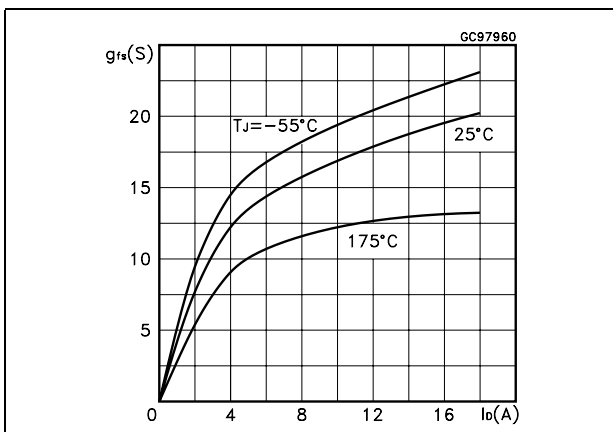

Figure 6. Static drain-source on resistance

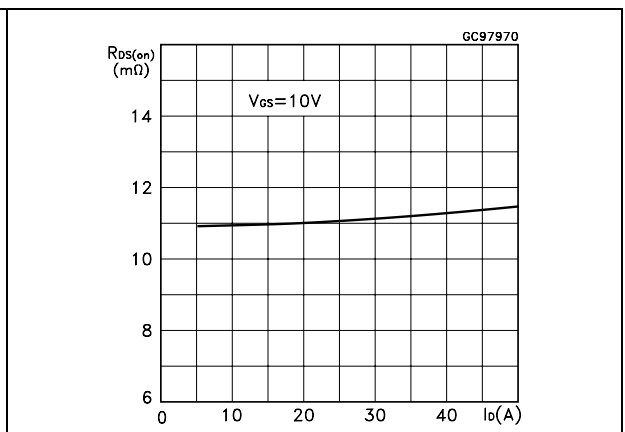

Figure 7. Gate charge vs gate-source voltage Figure 8. Capacitance variations

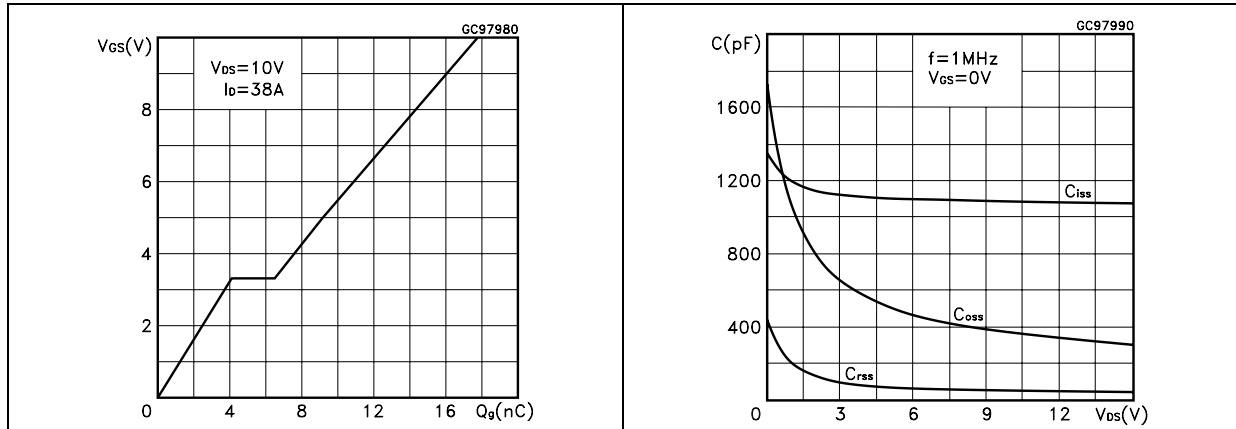

Figure 9. Normalized gate threshold voltage vs temperature Figure 10. Normalized on resistance vs temperature

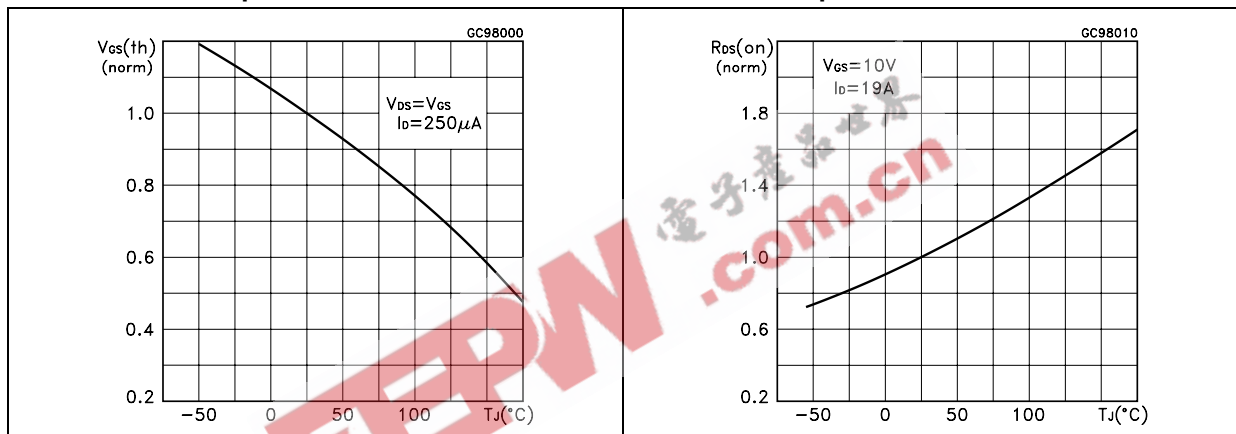
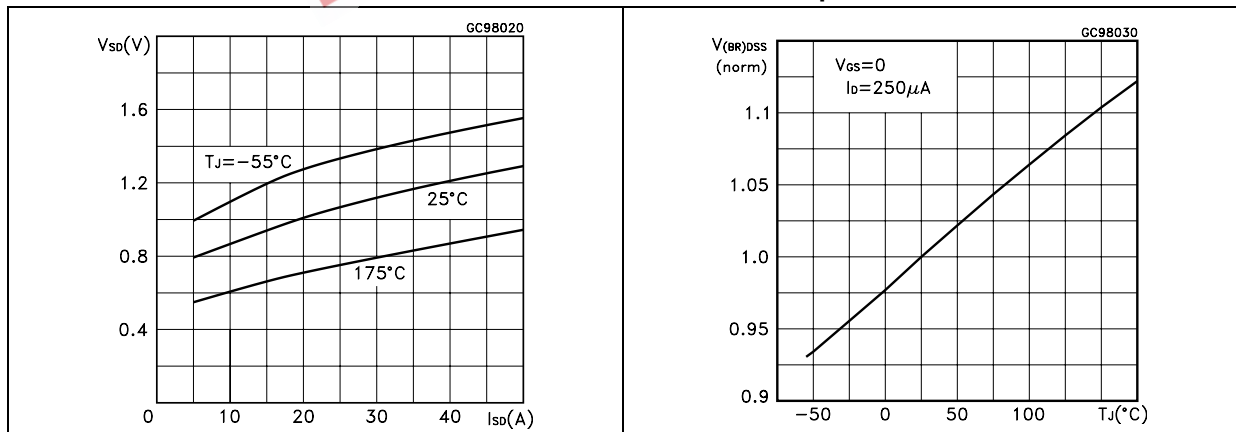

Figure 11. Source-drain diode forward characteristics Figure 12. Normalized breakdown voltage vs temperature



3 Test circuit

Figure 13. Switching times test circuit for resistive load



Figure 14. Gate charge test circuit



Figure 15. Test circuit for inductive load switching and diode recovery times

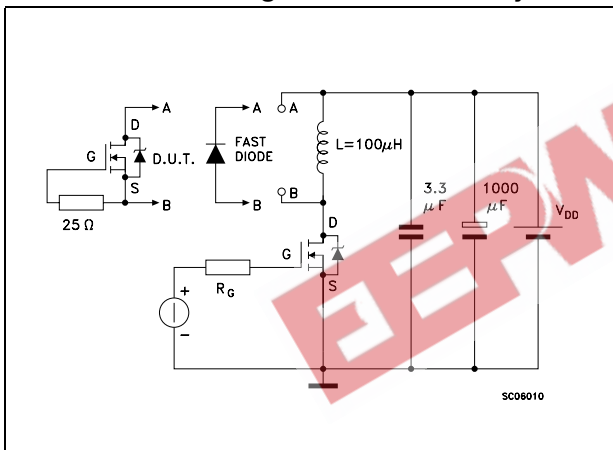

Figure 16. Unclamped Inductive load test circuit

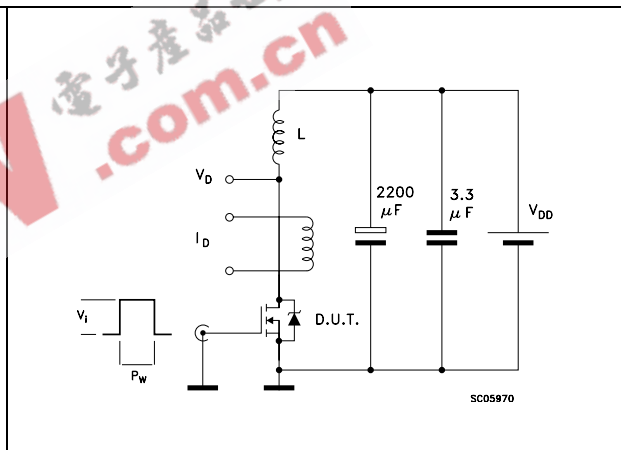
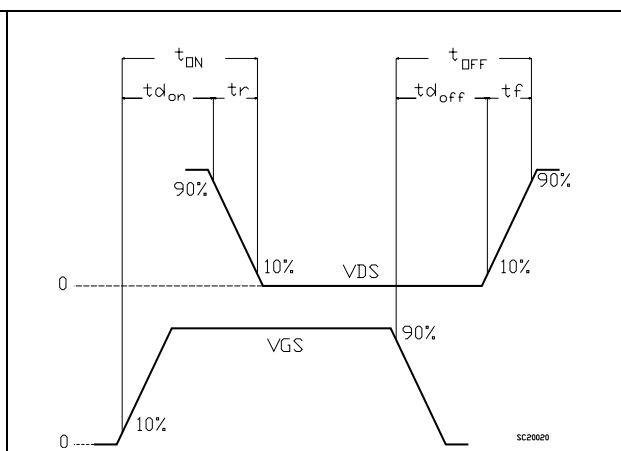

Figure 17. Unclamped inductive waveform

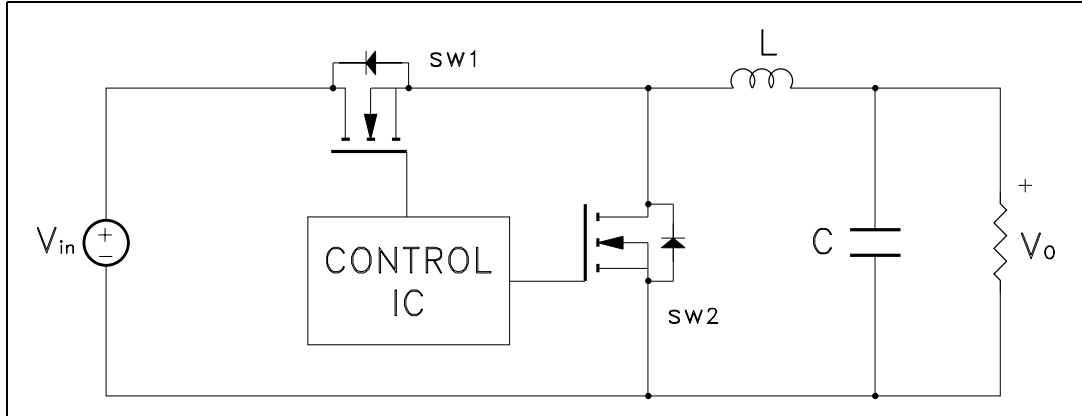

Figure 18. Switching time waveform



4 Appendix A

Figure 19. Buck converter: power losses estimation



The power losses associated with the FETs in a synchronous buck converter can be estimated using the equations shown in the table below. The formulas give a good approximation, for the sake of performance comparison, of how different pairs of devices affect the converter efficiency. However a very important parameter, the working temperature, is not considered. The real device behavior is really dependent on how the heat generated inside the devices is removed to allow for a safer working junction temperature.

- The low side (SW2) device requires:
- Very low $R_{DS(on)}$ to reduce conduction losses
- Small Q_{gl} to reduce the gate charge losses
- Small C_{oss} to reduce losses due to output capacitance
- Small Q_{rr} to reduce losses on SW1 during its turn-on
- The C_{gd}/C_{gs} ratio lower than V_{th}/V_{gg} ratio especially with low drain to source voltage to avoid the cross conduction phenomenon;
- The high side (SW1) device requires:
- Small R_g and L_s to allow higher gate current peak and to limit the voltage feedback on the gate
- Small Q_g to have a faster commutation and to reduce gate charge losses
- Low $R_{DS(on)}$ to reduce the conduction losses.

Table 6. Power losses calculation

| | | High side switching (SW1) | Low side switch (SW2) |
|-------------|--------------|--|--|
| Pconduction | | $R_{DS(on)SW1} * I_L^2 * \delta$ | $R_{DS(on)SW2} * I_L^2 * (1 - \delta)$ |
| Pswitching | | $V_{in} * (Q_{gsth(SW1)} + Q_{gd(SW1)}) * f * \frac{I_L}{I_g}$ | Zero Voltage Switching |
| Pdiode | Recovery (1) | Not applicable | $V_{in} * Q_{rr(SW2)} * f$ |
| | Conduction | Not applicable | $V_{f(SW2)} * I_L * t_{deadtime} * f$ |
| Pgate(QG) | | $Q_{g(SW1)} * V_{gg} * f$ | $Q_{gls(SW2)} * V_{gg} * f$ |
| PQoss | | $\frac{V_{in} * Q_{oss(SW1)} * f}{2}$ | $\frac{V_{in} * Q_{oss(SW2)} * f}{2}$ |

1. Dissipated by SW1 during turn-on

Table 7. Paramiters meaning

| Parameter | Meaning |
|-------------|--|
| d | Duty-cycle |
| Qgsth | Post threshold gate charge |
| Qgls | Third quadrant gate charge |
| Pconduction | On state losses |
| Pswitching | On-off transition losses |
| Pdiode | Conduction and reverse recovery diode losses |
| Pgate | Gate drive losses |
| PQoss | Output capacitance losses |

5 Package mechanical data

In order to meet environmental requirements, ST offers these devices in ECOPACK® packages. These packages have a Lead-free second level interconnect . The category of second level interconnect is marked on the package and on the inner box label, in compliance with JEDEC Standard JESD97. The maximum ratings related to soldering conditions are also marked on the inner box label. ECOPACK is an ST trademark. ECOPACK specifications are available at: www.st.com

EEPW 电子產品世界
.com.cn

TO-251 (IPAK) MECHANICAL DATA

| DIM. | mm | | | inch | | |
|------|------|------|------|-------|-------|-------|
| | MIN. | TYP. | MAX. | MIN. | TYP. | MAX. |
| A | 2.2 | | 2.4 | 0.086 | | 0.094 |
| A1 | 0.9 | | 1.1 | 0.035 | | 0.043 |
| A3 | 0.7 | | 1.3 | 0.027 | | 0.051 |
| B | 0.64 | | 0.9 | 0.025 | | 0.031 |
| B2 | 5.2 | | 5.4 | 0.204 | | 0.212 |
| B3 | | | 0.85 | | | 0.033 |
| B5 | | 0.3 | | | 0.012 | |
| B6 | | | 0.95 | | | 0.037 |
| C | 0.45 | | 0.6 | 0.017 | | 0.023 |
| C2 | 0.48 | | 0.6 | 0.019 | | 0.023 |
| D | 6 | | 6.2 | 0.236 | | 0.244 |
| E | 6.4 | | 6.6 | 0.252 | | 0.260 |
| G | 4.4 | | 4.6 | 0.173 | | 0.181 |
| H | 15.9 | | 16.3 | 0.626 | | 0.641 |
| L | 9 | | 9.4 | 0.354 | | 0.370 |
| L1 | 0.8 | | 1.2 | 0.031 | | 0.047 |
| L2 | | 0.8 | 1 | | 0.031 | 0.039 |

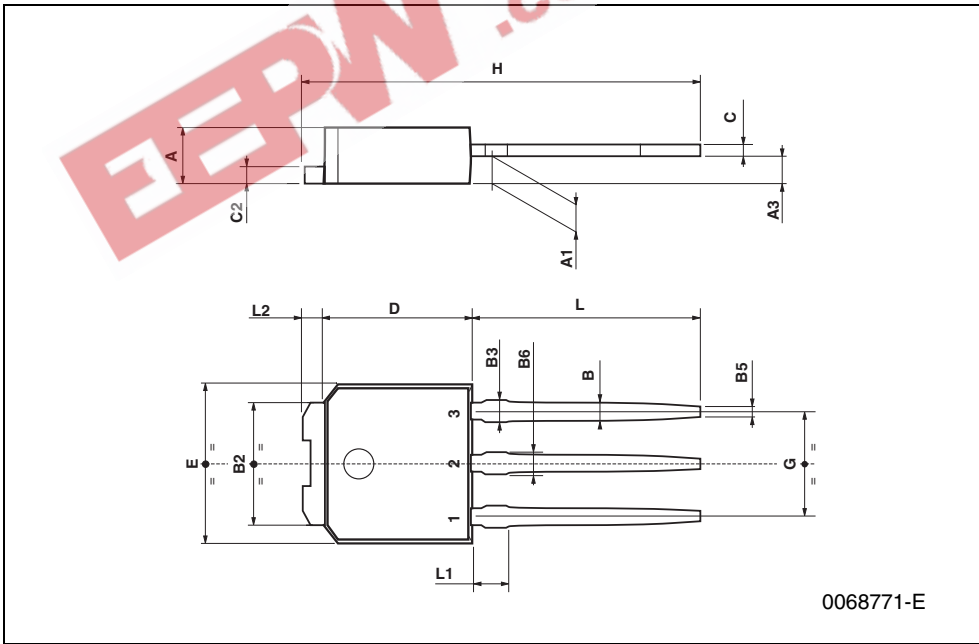

0068771-E

DPAK MECHANICAL DATA

| DIM. | mm. | | | inch | | |
|------|------|------|------|-------|-------|-------|
| | MIN. | TYP. | MAX. | MIN. | TYP. | MAX. |
| A | 2.2 | | 2.4 | 0.086 | | 0.094 |
| A1 | 0.9 | | 1.1 | 0.035 | | 0.043 |
| A2 | 0.03 | | 0.23 | 0.001 | | 0.009 |
| B | 0.64 | | 0.9 | 0.025 | | 0.035 |
| b4 | 5.2 | | 5.4 | 0.204 | | 0.212 |
| C | 0.45 | | 0.6 | 0.017 | | 0.023 |
| C2 | 0.48 | | 0.6 | 0.019 | | 0.023 |
| D | 6 | | 6.2 | 0.236 | | 0.244 |
| D1 | | 5.1 | | | 0.200 | |
| E | 6.4 | | 6.6 | 0.252 | | 0.260 |
| E1 | | 4.7 | | | 0.185 | |
| e | | 2.28 | | | 0.090 | |
| e1 | 4.4 | | 4.6 | 0.173 | | 0.181 |
| H | 9.35 | | 10.1 | 0.368 | | 0.397 |
| L | 1 | | | 0.039 | | |
| (L1) | | 2.8 | | | 0.110 | |
| L2 | | 0.8 | | | 0.031 | |
| L4 | 0.6 | | 1 | 0.023 | | 0.039 |
| R | | 0.2 | | | 0.008 | |
| V2 | 0° | | 8° | 0° | | 8° |

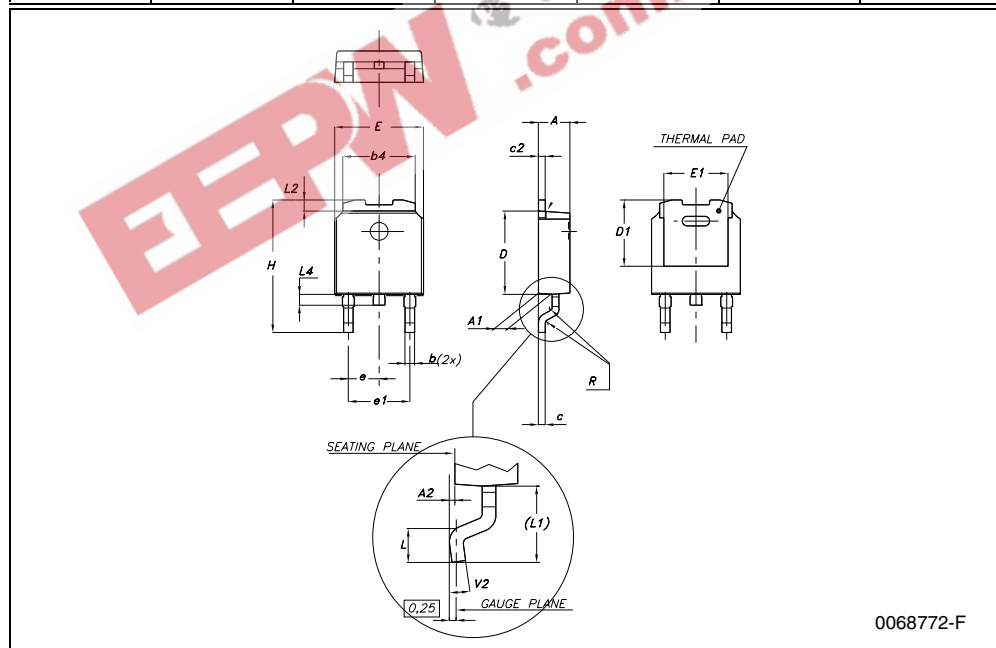

0068772-F

6 Packing mechanical data

DPAK FOOTPRINT

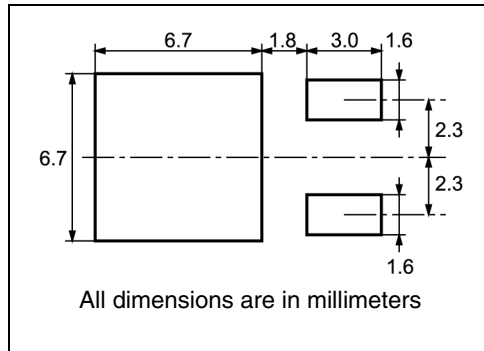

TAPE AND REEL SHIPMENT

40 mm min. Access hole at slot location

Full radius

Tape slot in core for tape start
2.5mm min. width

G measured at hub

REEL MECHANICAL DATA

| DIM. | mm | | inch | |
|------|------|------|-------|--------|
| | MIN. | MAX. | MIN. | MAX. |
| A | | 330 | | 12.992 |
| B | 1.5 | | 0.059 | |
| C | 12.8 | 13.2 | 0.504 | 0.520 |
| D | 20.2 | | 0.795 | |
| G | 16.4 | 18.4 | 0.645 | 0.724 |
| N | 50 | | 1.968 | |
| T | | 22.4 | | 0.881 |

TAPE MECHANICAL DATA

| DIM. | mm | | inch | |
|------|------|------|-------|-------|
| | MIN. | MAX. | MIN. | MAX. |
| A0 | 6.8 | 7 | 0.267 | 0.275 |
| B0 | 10.4 | 10.6 | 0.409 | 0.417 |
| B1 | | 12.1 | | 0.476 |
| D | 1.5 | 1.6 | 0.059 | 0.063 |
| D1 | 1.5 | | 0.059 | |
| E | 1.65 | 1.85 | 0.065 | 0.073 |
| F | 7.4 | 7.6 | 0.291 | 0.299 |
| K0 | 2.55 | 2.75 | 0.100 | 0.108 |
| P0 | 3.9 | 4.1 | 0.153 | 0.161 |
| P1 | 7.9 | 8.1 | 0.311 | 0.319 |
| P2 | 1.9 | 2.1 | 0.075 | 0.082 |
| R | 40 | | 1.574 | |
| W | 15.7 | 16.3 | 0.618 | 0.641 |

TOP COVER TAPE

User Direction of Feed

TRL

FEED DIRECTION

Bending radius R min.

10 pitches cumulative tolerance on tape +/- 0.2 mm

Center line of cavity

For machine ref. only including draft and radii concentric around B0

7 Revision history

Table 8. Revision history

| Date | Revision | Changes |
|-------------|----------|---------------------------------|
| 21-Jun-2004 | 7 | Preliminary version |
| 11-Jul-2006 | 8 | New template, no content change |

EEPW 电子產品世界
.com.cn

Please Read Carefully:

Information in this document is provided solely in connection with ST products. STMicroelectronics NV and its subsidiaries ("ST") reserve the right to make changes, corrections, modifications or improvements, to this document, and the products and services described herein at any time, without notice.

All ST products are sold pursuant to ST's terms and conditions of sale.

Purchasers are solely responsible for the choice, selection and use of the ST products and services described herein, and ST assumes no liability whatsoever relating to the choice, selection or use of the ST products and services described herein.

No license, express or implied, by estoppel or otherwise, to any intellectual property rights is granted under this document. If any part of this document refers to any third party products or services it shall not be deemed a license grant by ST for the use of such third party products or services, or any intellectual property contained therein or considered as a warranty covering the use in any manner whatsoever of such third party products or services or any intellectual property contained therein.

UNLESS OTHERWISE SET FORTH IN ST'S TERMS AND CONDITIONS OF SALE ST DISCLAIMS ANY EXPRESS OR IMPLIED WARRANTY WITH RESPECT TO THE USE AND/OR SALE OF ST PRODUCTS INCLUDING WITHOUT LIMITATION IMPLIED WARRANTIES OF MERCHANTABILITY, FITNESS FOR A PARTICULAR PURPOSE (AND THEIR EQUIVALENTS UNDER THE LAWS OF ANY JURISDICTION), OR INFRINGEMENT OF ANY PATENT, COPYRIGHT OR OTHER INTELLECTUAL PROPERTY RIGHT.

UNLESS EXPRESSLY APPROVED IN WRITING BY AN AUTHORIZED ST REPRESENTATIVE, ST PRODUCTS ARE NOT RECOMMENDED, AUTHORIZED OR WARRANTED FOR USE IN MILITARY, AIR CRAFT, SPACE, LIFE SAVING, OR LIFE SUSTAINING APPLICATIONS, NOR IN PRODUCTS OR SYSTEMS WHERE FAILURE OR MALFUNCTION MAY RESULT IN PERSONAL INJURY, DEATH, OR SEVERE PROPERTY OR ENVIRONMENTAL DAMAGE. ST PRODUCTS WHICH ARE NOT SPECIFIED AS "AUTOMOTIVE GRADE" MAY ONLY BE USED IN AUTOMOTIVE APPLICATIONS AT USER'S OWN RISK.

Resale of ST products with provisions different from the statements and/or technical features set forth in this document shall immediately void any warranty granted by ST for the ST product or service described herein and shall not create or extend in any manner whatsoever, any liability of ST.

ST and the ST logo are trademarks or registered trademarks of ST in various countries.

Information in this document supersedes and replaces all information previously supplied.

The ST logo is a registered trademark of STMicroelectronics. All other names are the property of their respective owners.

© 2006 STMicroelectronics - All rights reserved

STMicroelectronics group of companies

Australia - Belgium - Brazil - Canada - China - Czech Republic - Finland - France - Germany - Hong Kong - India - Israel - Italy - Japan - Malaysia - Malta - Morocco - Singapore - Spain - Sweden - Switzerland - United Kingdom - United States of America

www.st.com