



# STD100N03L-1 STD100N03L

N-CHANNEL 30V - 0.0045Ω - 80A - DPAK - IPAK  
Planar STripFET™ MOSFET

## General features

Type	V <sub>DSSS</sub>	R <sub>DS(on)</sub>	I <sub>D</sub>	P <sub>w</sub>
STD100N03L	30 V	<0.0055 Ω	80 A(1)	110 W
STD100N03L-1	30 V	<0.0055 Ω	80 A(1)	110 W

- 100% AVALANCHE TESTED
- SURFACE-MOUNTING DPAK (TO-252)
- LOGIC LEVEL THRESHOLD

## Description

This MOSFET is the latest refinement of STMicroelectronic unique "Single Feature Size™" strippased process. The resulting transistor shows extremely high packing density for low on-resistance, rugged avalanche characteristics, low gate charge and less critical alignment steps therefore a remarkable manufacturing reproducibility. This new improved device has been specifically designed for Automotive application and DC-DC converters.

## Applications

- HIGH CURRENT, HIGH SWITCHING DC-DC CONVERTER
- AUTOMOTIVE

## Order codes

Sales Type	Marking	Package	Packaging
STD100N03LT4	D100N03L	DPAK	TAPE & REEL
STD100N03L-1	D100N03L-1	IPAK	TUBE

## Package

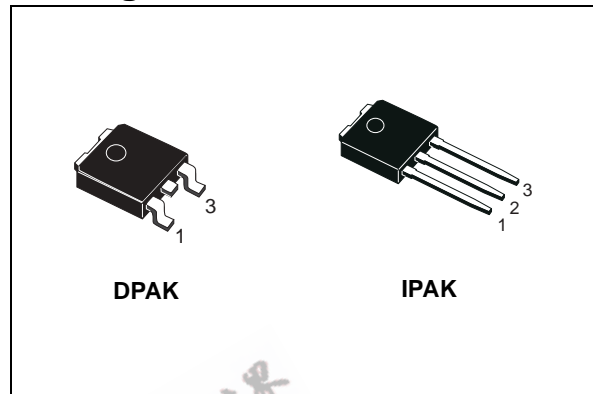

## Internal schematic diagram

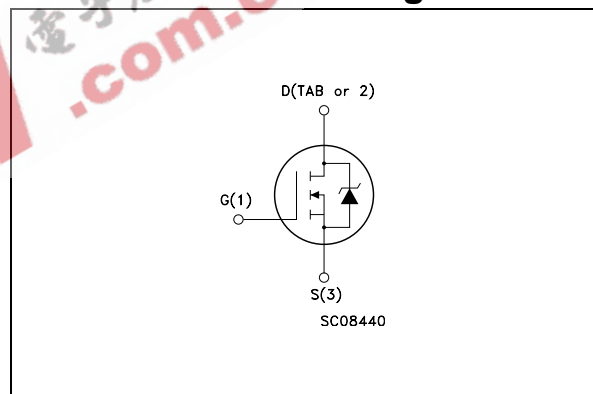

# 1 Electrical ratings

**Table 1. Absolute maximum ratings**

Symbol	Parameter	Value	Unit
$V_{DS}$	Drain-Source Voltage ( $V_{GS} = 0$ )	30	V
$V_{GS}$	Gate-Source Voltage	$\pm 20$	V
$I_D$ <i>Note 1</i>	Drain Current (continuous) at $T_C = 25^\circ\text{C}$	80	A
$I_D$	Drain Current (continuous) at $T_C = 100^\circ\text{C}$	70	A
$I_{DM}$ <i>Note 2</i>	Drain Current (pulsed)	320	A
$P_{TOT}$	Total Dissipation at $T_C = 25^\circ\text{C}$	110	W
	Derating Factor	0.73	W/°C
dv/dt <i>Note 3</i>	Peak Diode Recovery Voltage Slope	3.9	V/ns
$T_j$ $T_{stg}$	Operating Junction Temperature Storage Temperature	-55 to 175	°C

**Table 2. Thermal Data**

Rthj-case	Thermal Resistance Junction-case Max	1.36	°C/W
Rthj-amb	Thermal Resistance Junction-ambient Max	100	°C/W
$T_l$	Maximum Lead Temperature For Soldering Purpose (for 10sec. 1.6 mm from case)	275	°C

**Table 3. Avalanche characteristics**

Symbol	Parameter	Value	Unit
$I_{AV}$	Not-Repetitive Avalanche Current (pulse width limited by $T_j$ max)	40	A
$E_{AS}$	Single pulsed avalanche Energy (starting $T_j=25^\circ\text{C}$ , $I_D=I_{AV}$ , $V_{DD} = 24\text{V}$ )	500	mJ

## 2 Electrical characteristics

(T<sub>CASE</sub> = 25 °C unless otherwise specified)

**Table 4. On/Off states**

Symbol	Parameter	Test Conditions	Min.	Typ.	Max.	Unit
V <sub>(BR)DSS</sub>	Drain-Source Breakdown Voltage	I <sub>D</sub> = 250μA, V <sub>GS</sub> = 0	30			V
I <sub>DSS</sub>	Zero Gate Voltage Drain Current (V <sub>GS</sub> = 0)	V <sub>DS</sub> = Max Rating, V <sub>DS</sub> = Max Rating, T <sub>c</sub> = 125°C			10 100	μA μA
I <sub>GSS</sub>	Gate Body Leakage Current (V <sub>DS</sub> = 0)	V <sub>DS</sub> = ± 20 V			±200	nA
V <sub>GS(th)</sub>	Gate Threshold Voltage	V <sub>DS</sub> = V <sub>GS</sub> , I <sub>D</sub> = 250 μA	1			V
R <sub>DS(on)</sub>	Static Drain-Source On Resistance	V <sub>GS</sub> = 10 V, I <sub>D</sub> = 40 A V <sub>GS</sub> = 5 V, I <sub>D</sub> = 20 A		0.0045 0.008	0.0055 0.01	Ω Ω
R <sub>DS(on)</sub>	Static Drain-Source On Resistance	V <sub>GS</sub> = 10 V, I <sub>D</sub> = 40 A @ 125°C V <sub>GS</sub> = 5 V, I <sub>D</sub> = 20 A @ 125°C		0.0068 0.0146		Ω Ω

**Table 5. Dynamic**

Symbol	Parameter	Test Conditions	Min.	Typ.	Max.	Unit
g <sub>fs</sub> <i>Note 4</i>	Forward Transconductance	V <sub>DS</sub> = 10 V, I <sub>D</sub> = 15 A		31		S
C <sub>iss</sub>	Input Capacitance	V <sub>DS</sub> = 25V, f = 1 MHz, V <sub>GS</sub> = 0		2060		pF
C <sub>oss</sub>	Output Capacitance			728		pF
C <sub>rss</sub>	Reverse Transfer Capacitance			67		pF
Q <sub>g</sub>	Total Gate Charge	V <sub>DD</sub> = 24 V, I <sub>D</sub> = 80 A, V <sub>GS</sub> = 5V (see Figure 15)		20	27	nC
Q <sub>gs</sub>	Gate-Source Charge			7		nC
Q <sub>gd</sub>	Gate-Drain Charge			7.5		nC
R <sub>G</sub>	Gate Input Resistance	f = 1 MHz Gate DC Bias = 0 Test Signal Level = 20mV Open Drain		1.9		Ω

**Table 6. Switching time**

Symbol	Parameter	Test Conditions	Min.	Typ.	Max.	Unit
t <sub>d(on)</sub>	Turn-on Delay Time	V <sub>DD</sub> = 15 V, I <sub>D</sub> = 40 A R <sub>G</sub> = 4.7 Ω, V <sub>GS</sub> = 10V, (see Figure 14)		9		ns
t <sub>r</sub>	Rise Time			205		ns
t <sub>d(off)</sub>	Turn-off Delay Time	V <sub>DD</sub> = 15 V, I <sub>D</sub> = 40 A R <sub>G</sub> = 4.7 Ω, V <sub>GS</sub> = 10V, (see Figure 14)		31		ns
t <sub>f</sub>	Fall Time			35		ns

**Table 7. Source-Drain Diode**

Symbol	Parameter	Test Conditions	Min.	Typ.	Max.	Unit
$I_{SD}$	Source-Drain Current				80	A
$I_{SDM}$ <i>Note 2</i>	Source-Drain Current (pulsed)				320	A
$V_{SD}$ <i>Note 4</i>	Forward On Voltage	$I_{SD} = 40\text{ A}, V_{GS} = 0$			1.3	V
$t_{rr}$	Reverse Recovery Time	$I_{SD} = 80\text{ A}, di/dt = 100\text{ A}/\mu\text{s}$		40		ns
$Q_{rr}$	Reverse Recovery Charge	$V_{DD} = 25\text{ V}, T_j = 150\text{ }^\circ\text{C}$		40		nC
$I_{RRM}$	Reverse Recovery Current	(see Figure 16)		2		A

(1) Current limited by package.

(2) Pulse width limited by safe operating area

(3)  $I_{SD} \leq 80\text{ A}$ ,  $di/dt \leq 360\text{ A}/\mu\text{s}$ ,  $V_{DS} \leq V_{(BR)DSS}$ ,  $T_j \leq T_{jMAX}$

(4) Pulsed: Pulse duration = 300  $\mu\text{s}$ , duty cycle 1.5%

EEPW.com.cn 电子产品世界

## 2.1 Electrical characteristics (curves)

Figure 1. Safe Operating Area

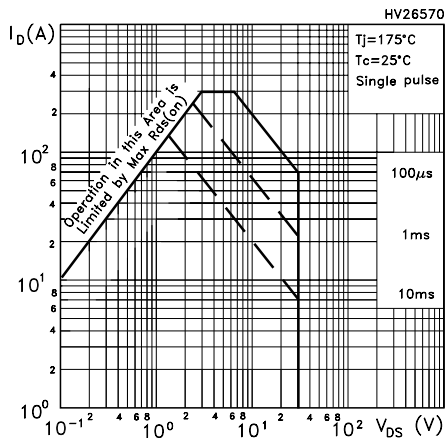

Figure 2. Thermal Impedance

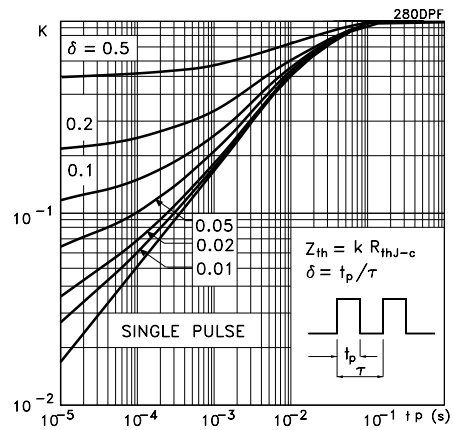

Figure 3. Output Characteristics

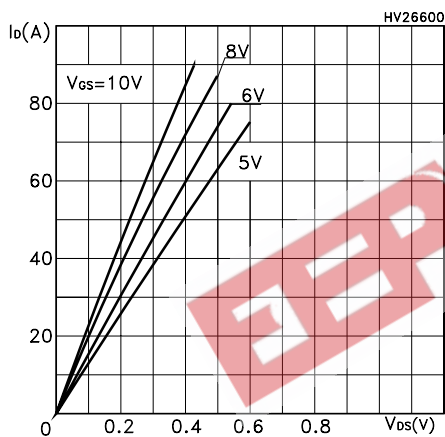

Figure 4. Transfer Characteristics

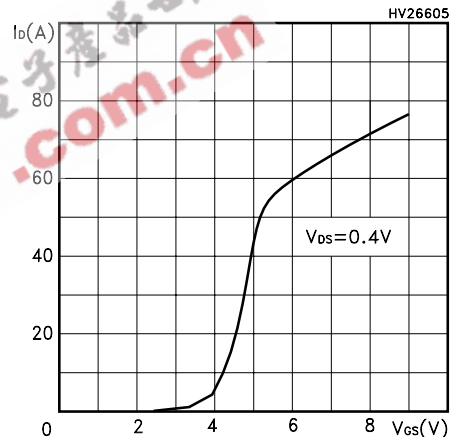

Figure 5. Transconductance

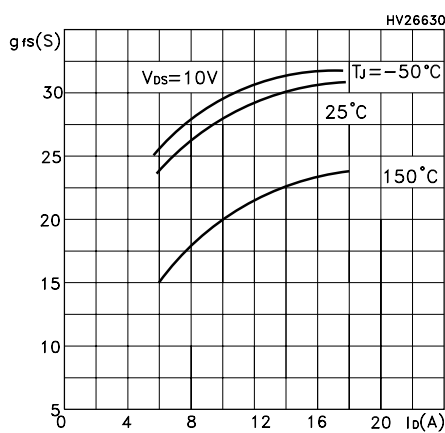
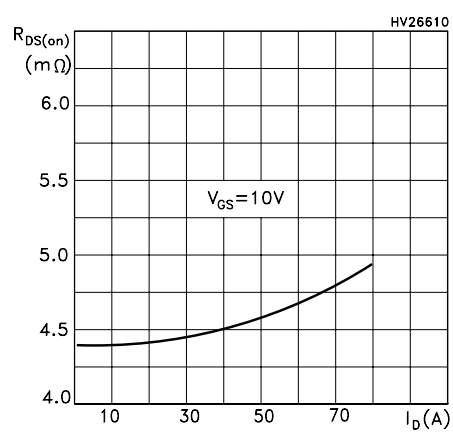
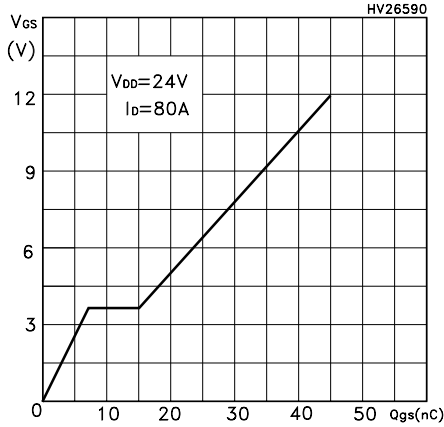

Figure 6. Static Drain-source on Resistance



**Figure 7. Gate Charge vs Gate-source Voltage**



**Figure 8. Capacitance Variation**

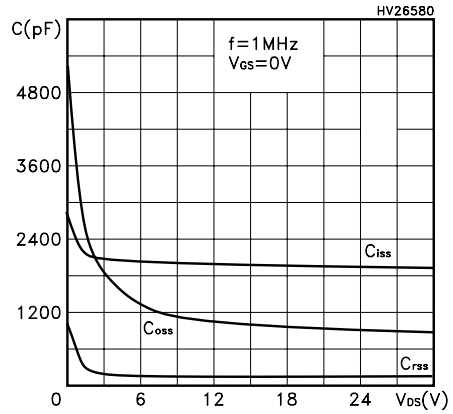

**Figure 9. Normalized Gate Threshold Voltage vs Temperature**

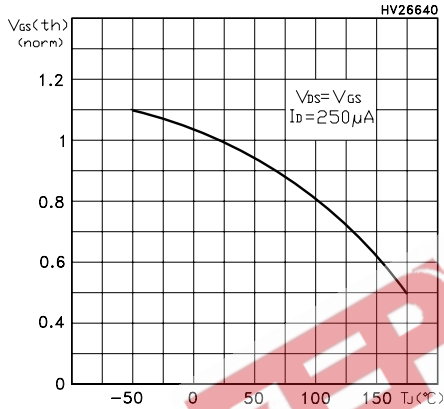

**Figure 10. Normalized BVDSS vs Temperature**

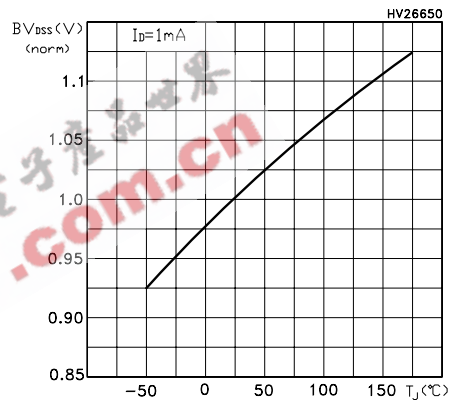

**Figure 11. Normalized on Resistance vs Temperature**

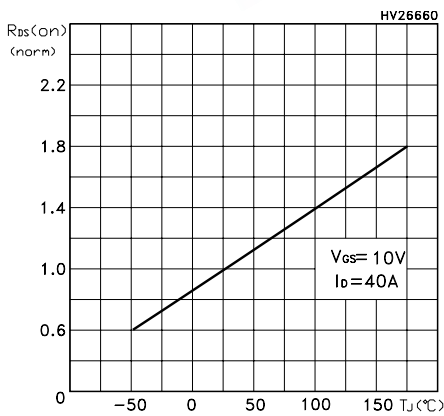

**Figure 12. Source-Drain Diode Forward Characteristics**

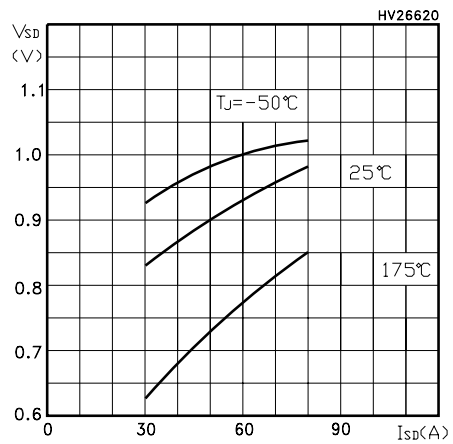
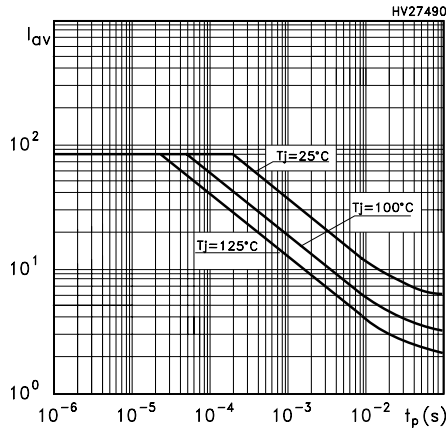

Figure 13. Allowable I<sub>AV</sub> vs. Time in Avalanche



The previous curve gives the single pulse safe operating area for unclamped inductive loads, under the following conditions:

$$P_{D(AVE)} = 0.5 * (1.3 * BV_{DSS} * I_{AV})$$

$$E_{AS(AR)} = P_{D(AVE)} * t_{AV}$$

Where:

I<sub>AV</sub> is the Allowable Current in Avalanche

P<sub>D(AVE)</sub> is the Average Power Dissipation in Avalanche (Single Pulse)

t<sub>AV</sub> is the Time in Avalanche



### 3 Test Circuits

Figure 14. Switching Times Test Circuit For Resistive Load

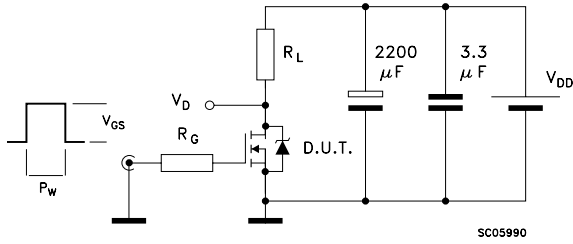

Figure 15. Gate Charge Test Circuit

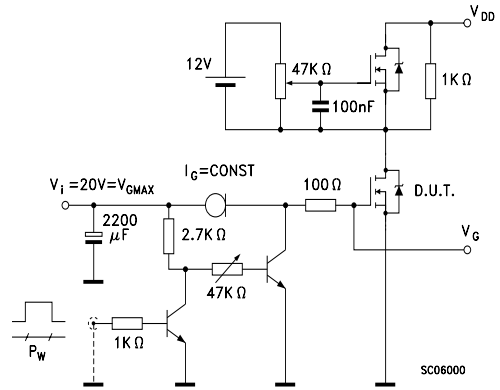
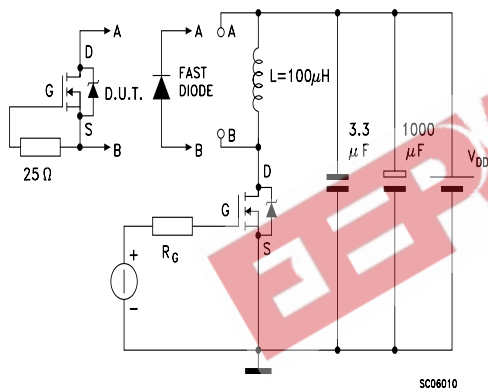

Figure 16. Test Circuit For Inductive Load Switching and Diode Recovery Times





## 4 Package Mechanical Data

In order to meet environmental requirements, ST offers these devices in ECOPACK® packages. These packages have a Lead-free second level interconnect . The category of second level interconnect is marked on the package and on the inner box label, in compliance with JEDEC Standard JESD97. The maximum ratings related to soldering conditions are also marked on the inner box label. ECOPACK is an ST trademark. ECOPACK specifications are available at: [www.st.com](http://www.st.com)

EEPW 电子產品世界  
.com.cn

**TO-251 (IPAK) MECHANICAL DATA**

DIM.	mm			inch		
	MIN.	TYP.	MAX.	MIN.	TYP.	MAX.
A	2.2		2.4	0.086		0.094
A1	0.9		1.1	0.035		0.043
A3	0.7		1.3	0.027		0.051
B	0.64		0.9	0.025		0.031
B2	5.2		5.4	0.204		0.212
B3			0.85			0.033
B5		0.3			0.012	
B6			0.95			0.037
C	0.45		0.6	0.017		0.023
C2	0.48		0.6	0.019		0.023
D	6		6.2	0.236		0.244
E	6.4		6.6	0.252		0.260
G	4.4		4.6	0.173		0.181
H	15.9		16.3	0.626		0.641
L	9		9.4	0.354		0.370
L1	0.8		1.2	0.031		0.047
L2		0.8	1		0.031	0.039

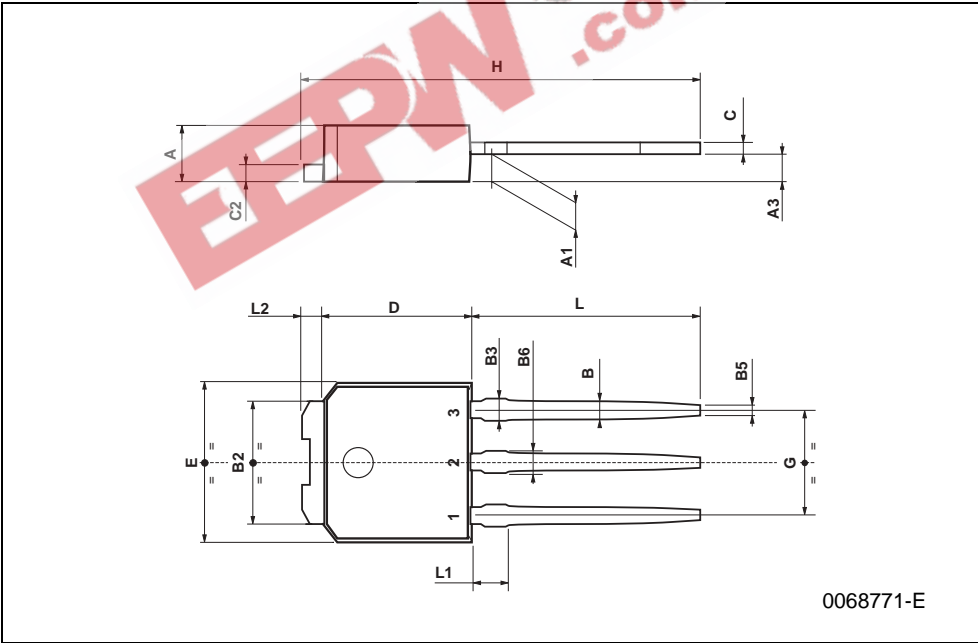

0068771-E



**TO-252 (DPAK) MECHANICAL DATA**

DIM.	mm			inch		
	MIN.	TYP.	MAX.	MIN.	TYP.	MAX.
A	2.20		2.40	0.087		0.094
A1	0.90		1.10	0.035		0.043
A2	0.03		0.23	0.001		0.009
B	0.64		0.90	0.025		0.035
B2	5.20		5.40	0.204		0.213
C	0.45		0.60	0.018		0.024
C2	0.48		0.60	0.019		0.024
D	6.00		6.20	0.236		0.244
E	6.40		6.60	0.252		0.260
G	4.40		4.60	0.173		0.181
H	9.35		10.10	0.368		0.398
L2		0.8			0.031	
L4	0.60		1.00	0.024		0.039
V2	0°		8°	0°		0°

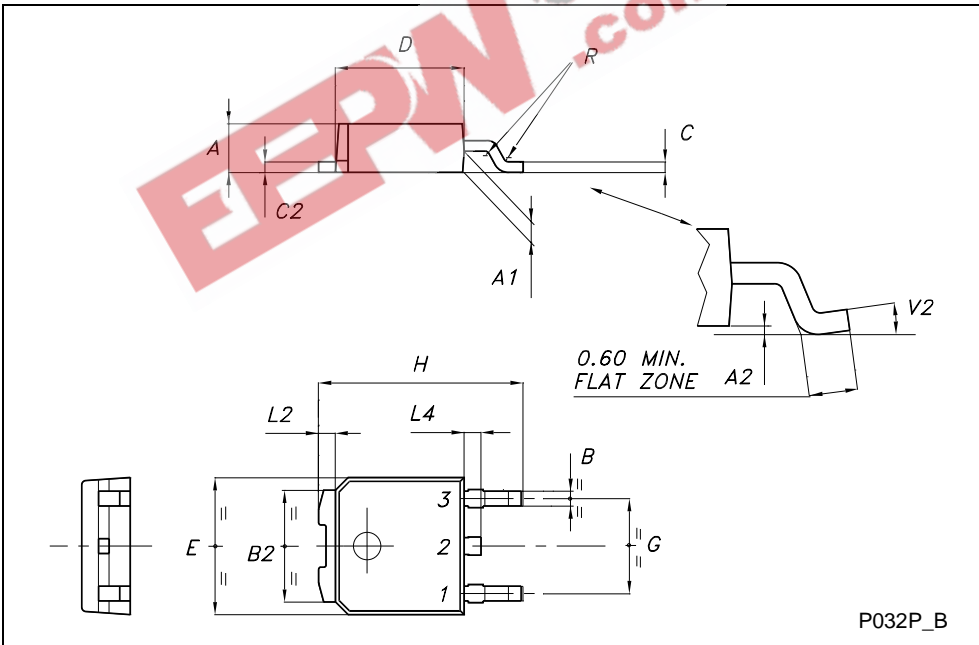

# 5 Packing mechanical data

## DPAK FOOTPRINT

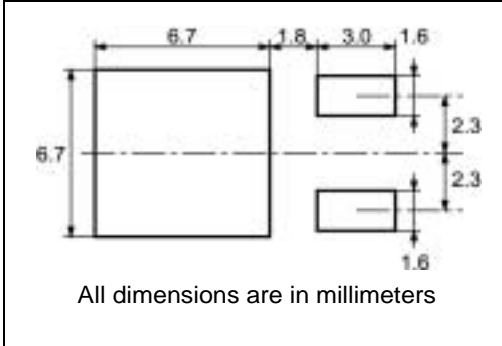

## TAPE AND REEL SHIPMENT

### REEL MECHANICAL DATA

DIM.	mm		inch	
	MIN.	MAX.	MIN.	MAX.
A		330		12.992
B	1.5		0.059	
C	12.8	13.2	0.504	0.520
D	20.2		0.795	
G	16.4	18.4	0.645	0.724
N	50		1.968	
T		22.4		0.881

BASE QTY	BULK QTY
2500	2500

### TAPE MECHANICAL DATA

DIM.	mm		inch	
	MIN.	MAX.	MIN.	MAX.
A0	6.8	7	0.267	0.275
B0	10.4	10.6	0.409	0.417
B1		12.1		0.476
D	1.5	1.6	0.059	0.063
D1	1.5		0.059	
E	1.65	1.85	0.065	0.073
F	7.4	7.6	0.291	0.299
K0	2.55	2.75	0.100	0.108
P0	3.9	4.1	0.153	0.161
P1	7.9	8.1	0.311	0.319
P2	1.9	2.1	0.075	0.082
R	40		1.574	
W	15.7	16.3	0.618	0.641

## 6 Revision History

Date	Revision	Changes
01-Sep-2005	1	Initial release.
14-Sep-2005	2	Value changed on <a href="#">Figure 1</a>

EEPW 电子產品世界  
.com.cn

EEPW 电子產品世界  
.com.cn

Information furnished is believed to be accurate and reliable. However, STMicroelectronics assumes no responsibility for the consequences of use of such information nor for any infringement of patents or other rights of third parties which may result from its use. No license is granted by implication or otherwise under any patent or patent rights of STMicroelectronics. Specifications mentioned in this publication are subject to change without notice. This publication supersedes and replaces all information previously supplied. STMicroelectronics products are not authorized for use as critical components in life support devices or systems without express written approval of STMicroelectronics.

The ST logo is a registered trademark of STMicroelectronics.  
All other names are the property of their respective owners

© 2005 STMicroelectronics - All rights reserved

STMicroelectronics group of companies

Australia - Belgium - Brazil - Canada - China - Czech Republic - Finland - France - Germany - Hong Kong - India - Israel - Italy - Japan -  
Malaysia - Malta - Morocco - Singapore - Spain - Sweden - Switzerland - United Kingdom - United States of America

[www.st.com](http://www.st.com)