

**Table 1: Main Features**

Symbol	Value	Unit
$I_{T(RMS)}$	0.8	A
$V_{DRM}/V_{RRM}$	600	V
$I_{GT}(Q_1)$	5	mA

**DESCRIPTION**

The **Z00607MA** is suitable for low power AC switching applications, such as fan speed, small light controllers...

Thanks to low gate triggering current, it can be directly driven by microcontrollers.

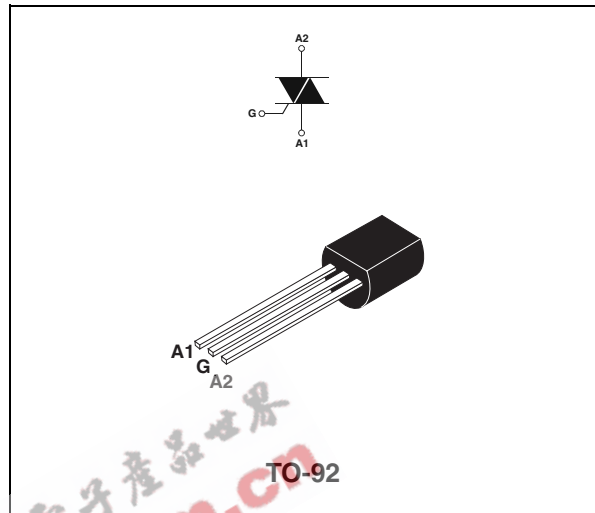

**Table 2: Order Codes**

Part Numbers	Marking
Z00607MA 1BA2	Z0607MA
Z00607MA 2BL2	Z0607MA
Z00607MA 5BL2	Z0607MA

**Table 3: Absolute Maximum Ratings**

Symbol	Parameter		Value	Unit	
$I_{T(RMS)}$	RMS on-state current (full sine wave)		$T_j = 50^\circ\text{C}$	0.8	A
$I_{TSM}$	Non repetitive surge peak on-state current (full cycle, $T_j$ initial = $25^\circ\text{C}$ )	F = 50 Hz	t = 20 ms	9	A
		F = 60 Hz	t = 16.7 ms	9.5	
$I^2t$	$I^2t$ Value for fusing	$t_p = 10$ ms		0.45	$\text{A}^2\text{s}$
di/dt	Critical rate of rise of on-state current $I_G = 2 \times I_{GT}$ , $t_r \leq 100$ ns	F = 120 Hz	$T_j = 110^\circ\text{C}$	20	A/ $\mu\text{s}$
$I_{GM}$	Peak gate current	$t_p = 20$ $\mu\text{s}$	$T_j = 110^\circ\text{C}$	1	A
$P_{G(AV)}$	Average gate power dissipation		$T_j = 110^\circ\text{C}$	0.1	W
$T_{stg}$ $T_j$	Storage junction temperature range Operating junction temperature range		- 40 to + 150 - 40 to + 110		$^\circ\text{C}$

**Tables 4: Electrical Characteristics** ( $T_j = 25^\circ\text{C}$ , unless otherwise specified)

Symbol	Test Conditions	Quadrant		Value	Unit
$I_{GT}$ (1)	$V_D = 12\text{ V}$ $R_L = 30\ \Omega$	I - II - III	MAX.	5	mA
		IV		7	
$V_{GT}$		ALL	MAX.	1.3	V
$V_{GD}$	$V_D = V_{DRM}$ $R_L = 3.3\text{ k}\Omega$ $T_j = 110^\circ\text{C}$	ALL	MIN.	0.2	V
$I_H$ (2)	$I_T = 200\text{ mA}$		MAX.	5	mA
$I_L$	$I_G = 1.2 I_{GT}$	I - III - IV	MAX.	10	mA
		II		20	
$dV/dt$ (2)	$V_D = 67\% V_{DRM}$ gate open $T_j = 110^\circ\text{C}$		MIN.	10	V/ $\mu\text{s}$
$(dI/dt)_c$ (2)	$(dV/dt)_c = 0.35\text{ A/ms}$ $T_j = 110^\circ\text{C}$		MIN.	1.5	A/ms

**Table 5: Static Characteristics**

Symbol	Test Conditions			Value	Unit	
$V_{TM}$ (2)	$I_{TM} = 1.1\text{ A}$	$t_p = 380\ \mu\text{s}$	$T_j = 25^\circ\text{C}$	MAX.	1.5	V
$V_{to}$ (2)	Threshold voltage		$T_j = 110^\circ\text{C}$	MAX.	0.95	V
$R_d$ (2)	Dynamic resistance		$T_j = 110^\circ\text{C}$	MAX.	420	m $\Omega$
$I_{DRM}$ $I_{RRM}$	$V_{DRM} = V_{RRM} = 600\text{ V}$		$T_j = 25^\circ\text{C}$	MAX.	5	$\mu\text{A}$
			$T_j = 110^\circ\text{C}$		0.1	mA

**Note 1:** minimum  $I_{GT}$  is guaranteed at 5% of  $I_{GT}$  max.

**Note 2:** for both polarities of A2 referenced to A1.

**Table 6: Thermal resistances**

Symbol	Parameter	Value	Unit
$R_{th(j-l)}$	Junction to lead (A.C.)	60	$^\circ\text{C/W}$
$R_{th(j-a)}$	Junction to ambient	150	$^\circ\text{C/W}$

**Figure 1: Maximum power dissipation versus RMS on-state current (full cycle)**

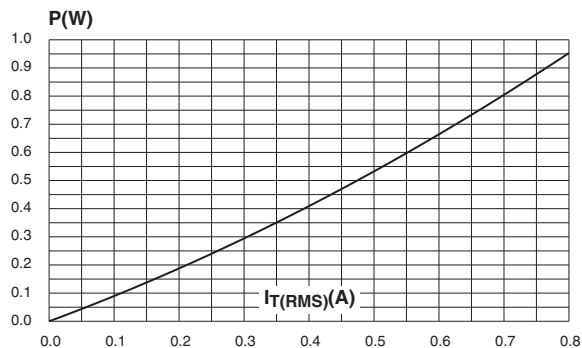

**Figure 2: RMS on-state current versus ambient temperature (full cycle)**

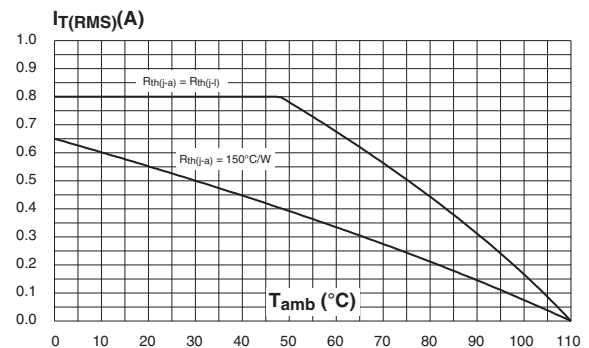

Figure 3: Relative variation of thermal impedance versus pulse duration

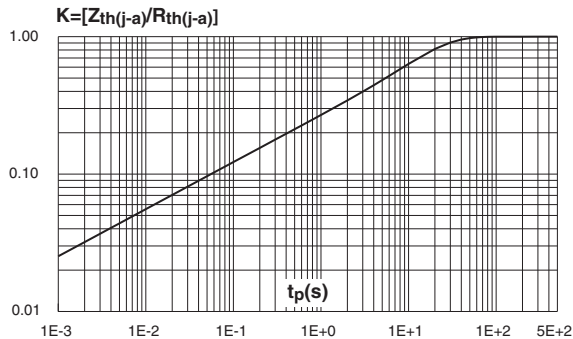

Figure 4: Relative variation of gate trigger current, holding current and latching current versus junction temperature (typical values)

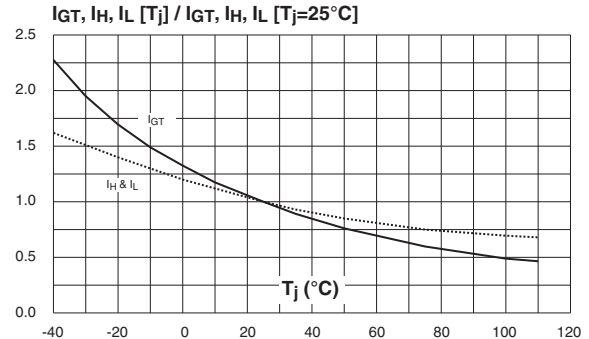

Figure 5: Surge peak on-state current versus number of cycles

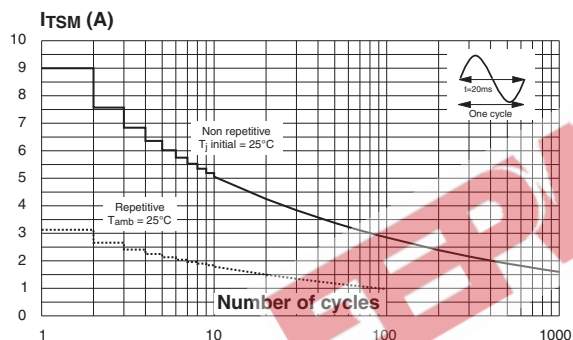

Figure 6: Non-repetitive surge peak on-state current for a sinusoidal pulse with width  $t_p < 10$  ms and corresponding value of  $I^2t$

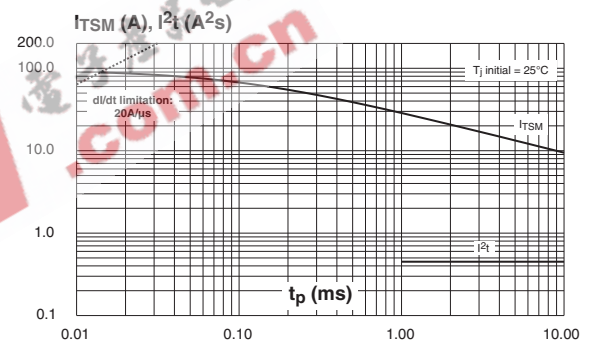

Figure 7: On-state characteristics (maximum values)

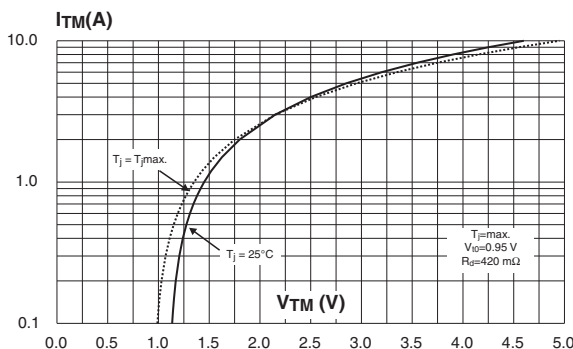
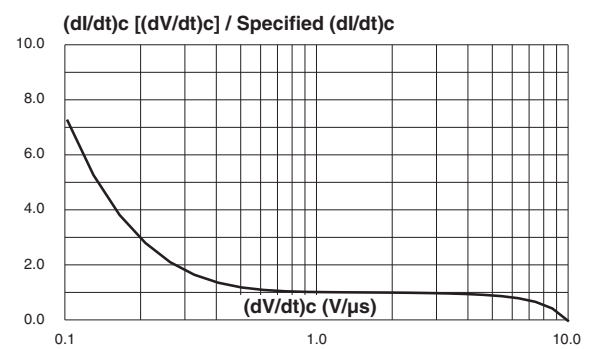
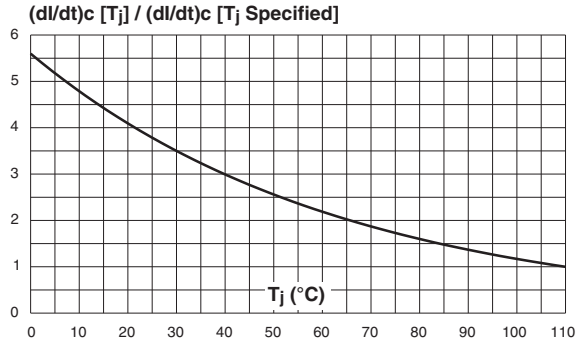

Figure 8: Relative variation of critical rate of decrease of main current versus  $(dV/dt)_c$  (typical values)



**Figure 9: Relative variation of critical rate of decrease of main current versus junction temperature**



**Figure 10: Ordering Information Scheme**

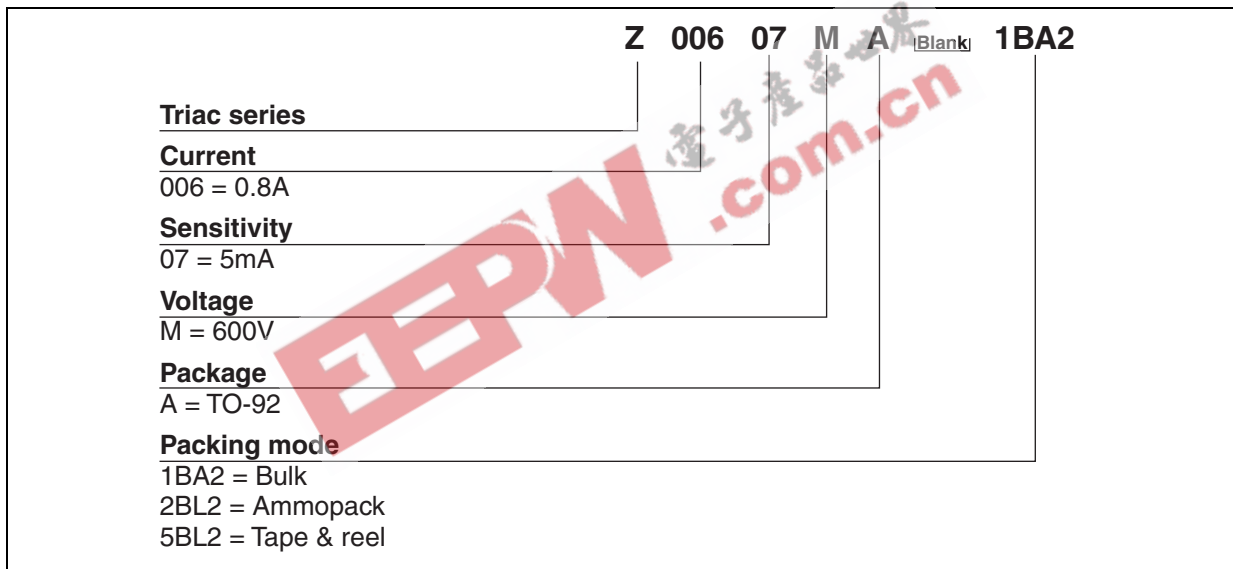

**Table 7: Product Selector**

Part Number	Voltage	Sensitivity	Type	Package
Z00607MA	600 V	5 mA	Standard	TO-92

Figure 11: TO-92 Package Mechanical Data

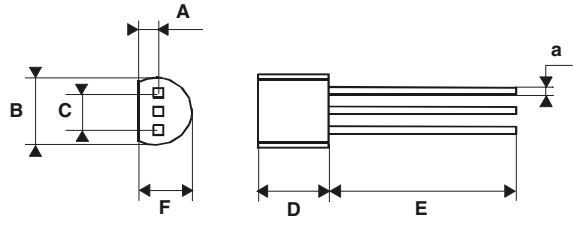

REF.	DIMENSIONS					
	Millimeters			Inches		
	Min.	Typ.	Max.	Min.	Typ.	Max.
A		1.35			0.053	
B			4.70			0.185
C		2.54			0.100	
D	4.40			0.173		
E	12.70			0.500		
F			3.70			0.146
a			0.50			0.019

Table 8: Ordering Information

Ordering type	Marking	Package	Weight	Base qty	Delivery mode
Z00607MA 1BA2	Z0607MA	TO-92	0.2 g	2500	Bulk
Z00607MA 2BL2	Z0607MA			2000	Ammopack
Z00607MA 5BL2	Z0607MA			2000	Tape & reel

Table 9: Revision History

Date	Revision	Description of Changes
Oct-2001	4	Last update.
25-Mar-2005	5	Package: TO-92 tape & reel delivery mode 5BL2 added.
21-Jun-2005	6	Markings updated from Z006xxxx to Z06xxxx
13-Sep-2005	7	Z00607MA 2BL2: marking corrected from 00607mA to Z0607MA



Information furnished is believed to be accurate and reliable. However, STMicroelectronics assumes no responsibility for the consequences of use of such information nor for any infringement of patents or other rights of third parties which may result from its use. No license is granted by implication or otherwise under any patent or patent rights of STMicroelectronics. Specifications mentioned in this publication are subject to change without notice. This publication supersedes and replaces all information previously supplied. STMicroelectronics products are not authorized for use as critical components in life support devices or systems without express written approval of STMicroelectronics.

The ST logo is a registered trademark of STMicroelectronics.  
All other names are the property of their respective owners

© 2005 STMicroelectronics - All rights reserved

**STMicroelectronics group of companies**

Australia - Belgium - Brazil - Canada - China - Czech Republic - Finland - France - Germany - Hong Kong - India - Israel - Italy - Japan -  
Malaysia - Malta - Morocco - Singapore - Spain - Sweden - Switzerland - United Kingdom - United States of America  
[www.st.com](http://www.st.com)