

**1.5A DDR TERMINATION REGULATOR****AP2301****General Description**

The AP2301 linear regulator is designed to meet the JEDEC specification SSTL-2 and SSTL-18 for termination of DDR-SDRAM. The regulator can sink or source up to 1.5A current continuously, offers enough current for most DDR applications. Output voltage is designed to track the reference voltage within a 2% tolerance for load regulation while preventing shooting through on the output stage. On-chip thermal limiting provides protection against a combination of high current and ambient temperature which would create an excessive junction temperature.

The AP2301, used in conjunction with series termination resistors, provides an excellent voltage source for active termination schemes of high speed transmission lines as those seen in high speed memory buses and distributed backplane designs.

The AP2301 is available in SOIC-8 and TO-252-5L packages.

Features

- Support Both DDR I ($1.25V_{TT}$) and DDR II ($0.9V_{TT}$) Requirements
- Source and Sink Current up to 1.5A
- High Accuracy Output Voltage at Full-load
- Adjustable V_{OUT} by External Resistors
- Shutdown for Standby or Suspend Mode
Operation with High-impedance Output

Applications

- DDR-SDRAM Termination
- DDR-II Termination
- SSTL-2 Termination

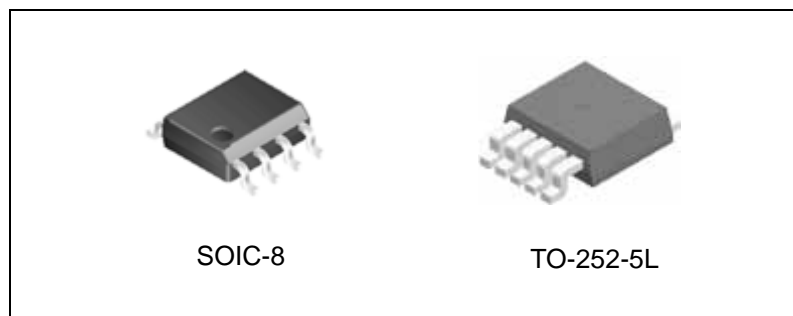

Figure 1. Package Types of AP2301



1.5A DDR TERMINATION REGULATOR **AP2301**

Pin Configuration

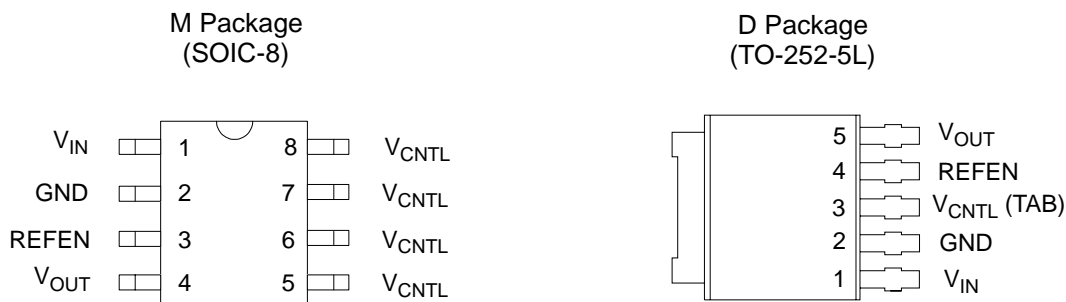

Figure 2. Pin Configuration of AP2301 (Top View)

Pin Description

Pin Number		Pin Name	Function
SOIC-8	TO-252-5L		
1	1	V_{IN}	Power Input
2	2	GND	Ground
3	4	REFEN	Reference Voltage Input and Chip Enable
4	5	V_{OUT}	Output Voltage
5, 6, 7, 8	3	V_{CNTL}	Supply Voltage for Internal Circuit (Internally Connected for SOIC-8), (TAB for TO-252-5L)



1.5A DDR TERMINATION REGULATOR AP2301

Functional Block Diagram

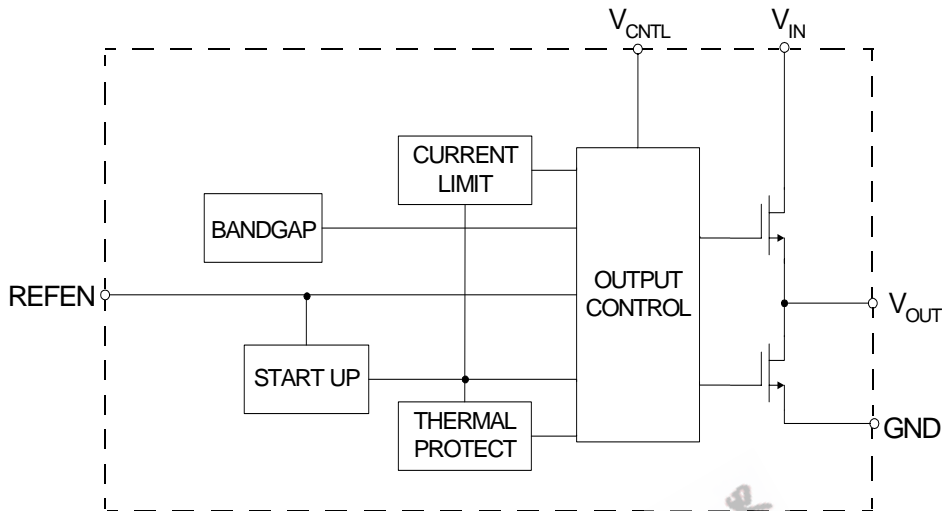
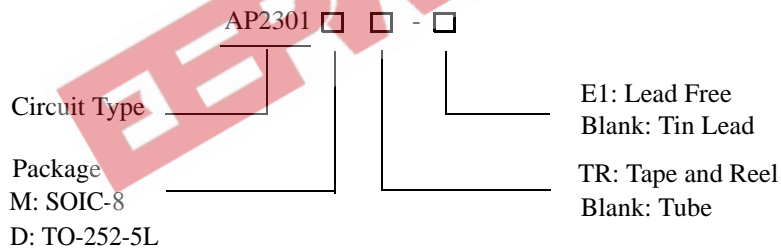

Figure 3. Functional Block Diagram of AP2301

Ordering Information



Package	Temperature Range	Part Number		Marking ID		Packing Type
		Tin Lead	Lead Free	Tin Lead	Lead Free	
SOIC-8	0 to 125°C	AP2301M	AP2301M-E1	2301M	2301M-E1	Tube
		AP2301MTR	AP2301MTR-E1	2301M	2301M-E1	Tape & Reel
TO-252-5L	0 to 125°C	AP2301D	AP2301D-E1	AP2301D	AP2301D-E1	Tube
		AP2301DTR	AP2301DTR-E1	AP2301D	AP2301D-E1	Tape & Reel

BCD Semiconductor's Pb-free products, as designated with "E1" suffix in the part number, are RoHS compliant.

**1.5A DDR TERMINATION REGULATOR****AP2301****Absolute Maximum Ratings (Note 1)**

Parameter	Symbol	Value		Unit
Supply Voltage for Internal Circuit	V_{CNTL}	7		V
Power Dissipation	P_D	Internally Limited		W
ESD (Human Body Model)	ESD	2		KV
Junction Temperature	T_J	150		°C
Storage Temperature Range	T_{STG}	-65 to 150		°C
Lead Temperature (Soldering, 10sec)	T_{LEAD}	260		°C
Package Thermal Resistance (Free Air)	θ_{JA}	SOIC-8	160	°C/W
		TO-252-5L	130	

Note 1: Stresses greater than those listed under "Absolute Maximum Ratings" may cause permanent damage to the device. These are stress ratings only, and functional operation of the device at these or any other conditions beyond those indicated under "Recommended Operating Conditions" is not implied. Exposure to "Absolute Maximum Ratings" for extended periods may affect device reliability.

Recommended Operating Conditions

Parameter	Symbol	Min	Typ	Max	Unit
Supply Voltage for Internal Circuit	V_{CNTL} (Note 2, 3)		3.3	6	V
Power Input	DDR I	1.6	2.5	V_{CNTL}	V
	DDR II		1.8		
Junction Temperature	T_J	0		125	°C

Note 2: Keep $V_{CNTL} \geq V_{IN}$ in power on and power off sequences.

Note 3: For safe operation, V_{CNTL} MUST be tied to 3.3V rather than 5V.

**1.5A DDR TERMINATION REGULATOR****AP2301****Electrical Characteristics**(T_J=25°C, V_{IN}=2.5V, V_{CNTL}=3.3V, V_{REFEN}=1.25V, C_{OUT}=10μF (Ceramic), unless otherwise specified.)

Parameter	Symbol	Conditions	Min	Typ	Max	Unit
Output Offset Voltage	V _{OS}	I _L =0A (Note 4)	-20	0	20	mV
Load Regulation	DDR I	I _L =0 to 1.5A		0.8	2	%
		I _L =0 to -1.5A		0.8	2	
	DDR II	I _L =0 to 1.5A		1.2	3	
		I _L =0 to -1.5A		1.2	3	
Quiescent Current of V _{CNTL}	I _Q	No Load		3	5	mA
Leakage Current in Shutdown Mode	I _{SHDN}	V _{REFEN} <0.2V, R _L =180Ω		3	6	μA
Protection						
Current Limit	I _{LIMIT}		2.1			A
Thermal Shutdown Temperature	T _{SHDN}	3.3V ≤ V _{CNTL} ≤ 5V		150		°C
Thermal Shutdown Hysteresis				50		°C
Shutdown Function						
Shutdown Threshold Trigger		Output = High	0.8			V
		Output = Low			0.2	

Note 4: V_{OS} is the voltage measurement defined as V_{OUT} subtracted from V_{REFEN}.



1.5A DDR TERMINATION REGULATOR

AP2301

Typical Performance Characteristics

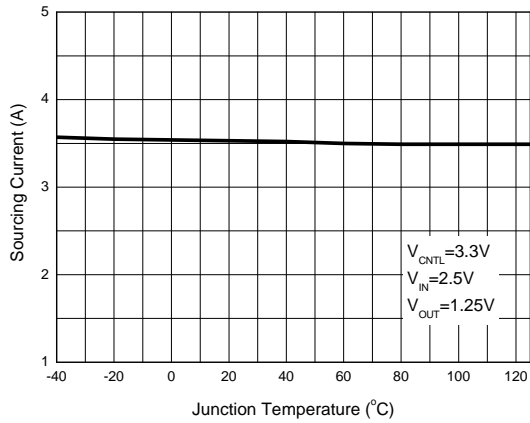

Figure 4. Sourcing Current vs. Junction Temperature

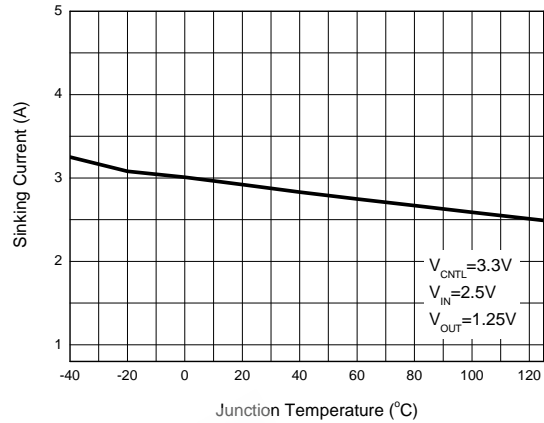

Figure 5. Sinking Current vs. Junction Temperature

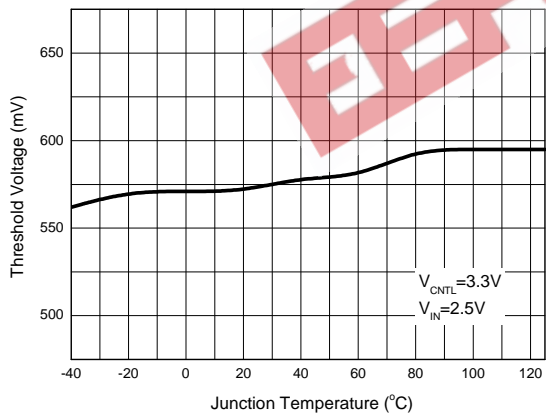

Figure 6. Threshold Voltage vs. Junction Temperature

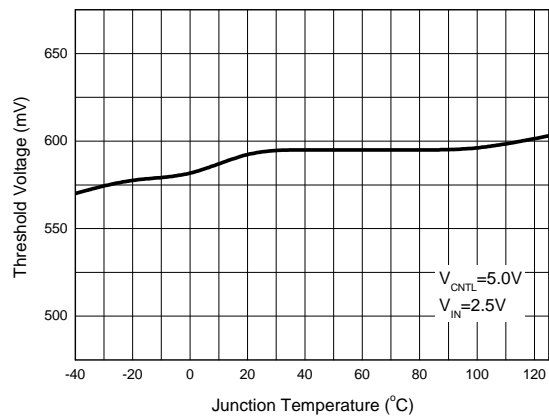

Figure 7. Threshold Voltage vs. Junction Temperature



1.5A DDR TERMINATION REGULATOR

AP2301

Typical Performance Characteristics (Continued)

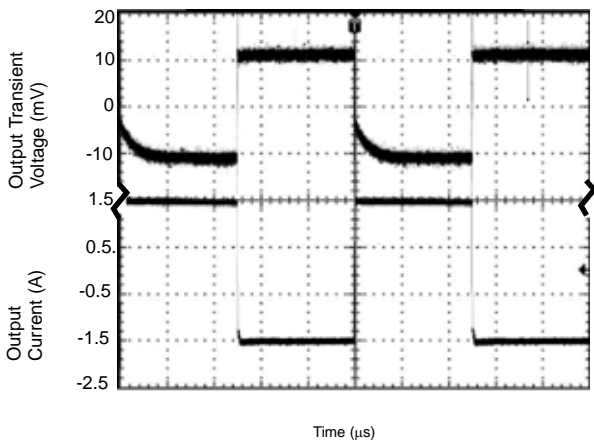

Figure 8. 0.9V_{TT} at 1.5A Transient Response
(Conditions: V_{IN}=2.5V, V_{CNTL}=3.3V, C_{OUT}=10µF)

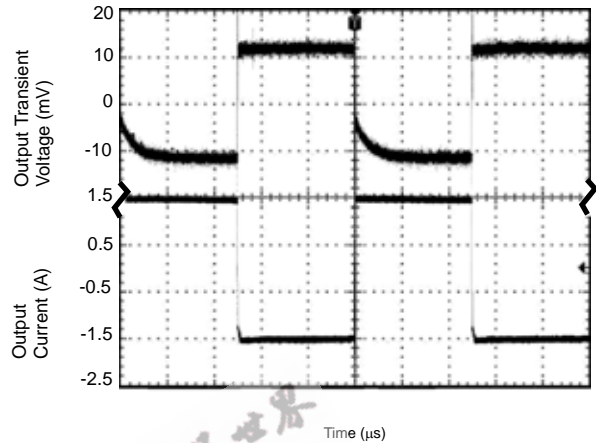

Figure 9. 1.25V_{TT} at 1.5A Transient Response
(Conditions: V_{IN}=2.5V, V_{CNTL}=3.3V, C_{OUT}=10µF)

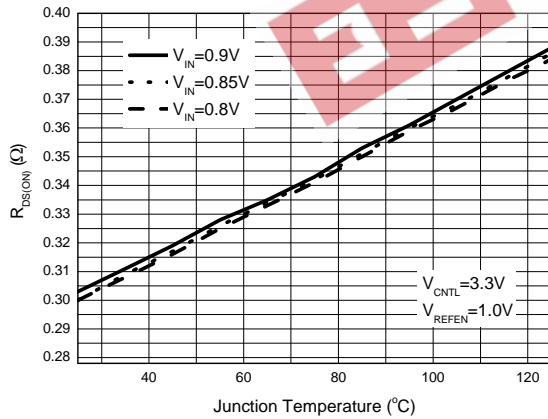

Figure 10. R_{DS(on)} vs. Junction Temperature

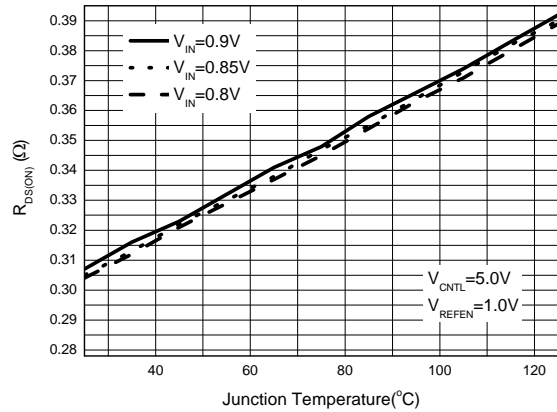

Figure 11. R_{DS(on)} vs. Junction Temperature



1.5A DDR TERMINATION REGULATOR

AP2301

Typical Performance Characteristics (Continued)

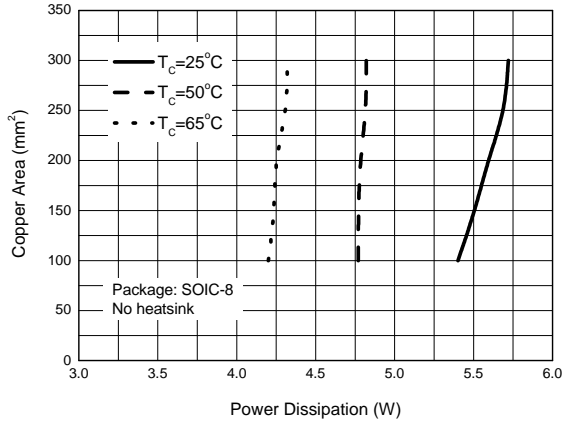

Figure 12. Copper Area vs. Power Dissipation

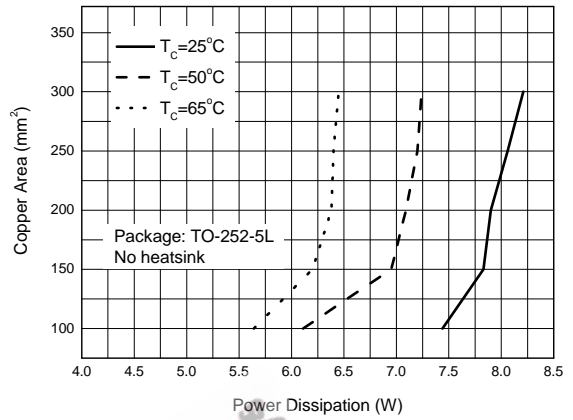

Figure 13. Copper Area vs. Power Dissipation



1.5A DDR TERMINATION REGULATOR **AP2301**

Typical Application

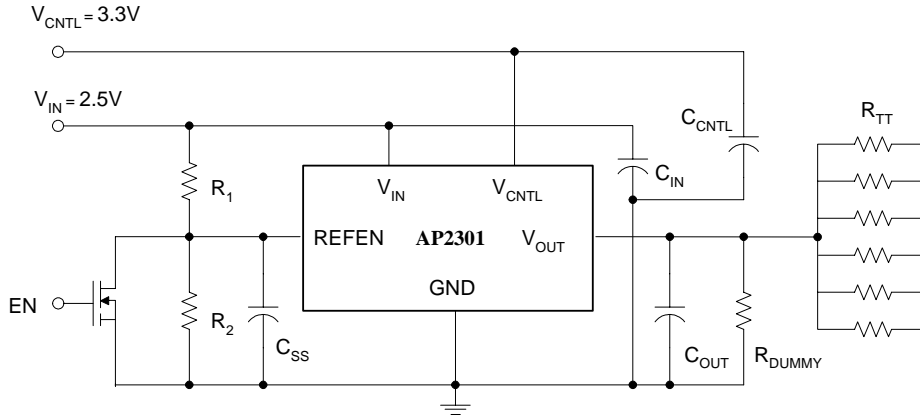
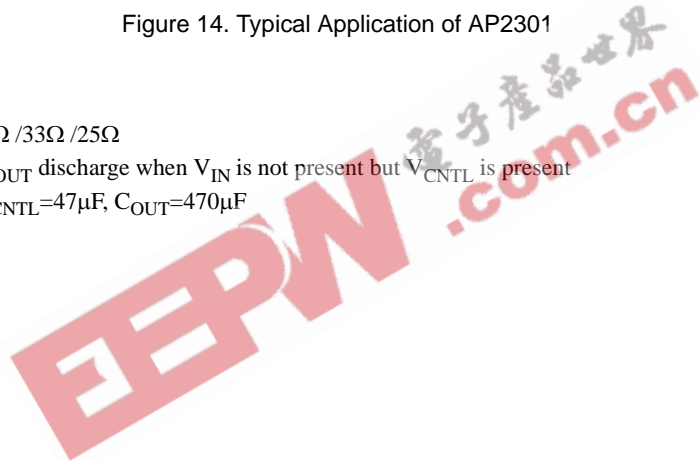

Figure 14. Typical Application of AP2301

$R_1=R_2=100K\Omega$, $R_{TT}=50\Omega / 33\Omega / 25\Omega$

$R_{DUMMY}=1K\Omega$, as for V_{OUT} discharge when V_{IN} is not present but $V_{_CNTL}$ is present

$C_{SS}=1\mu F$, $C_{IN}=470\mu F$, $C_{CNTL}=47\mu F$, $C_{OUT}=470\mu F$





1.5A DDR TERMINATION REGULATOR

AP2301

Mechanical Dimensions (Continued)

TO-252-5L

Unit: mm(inch)

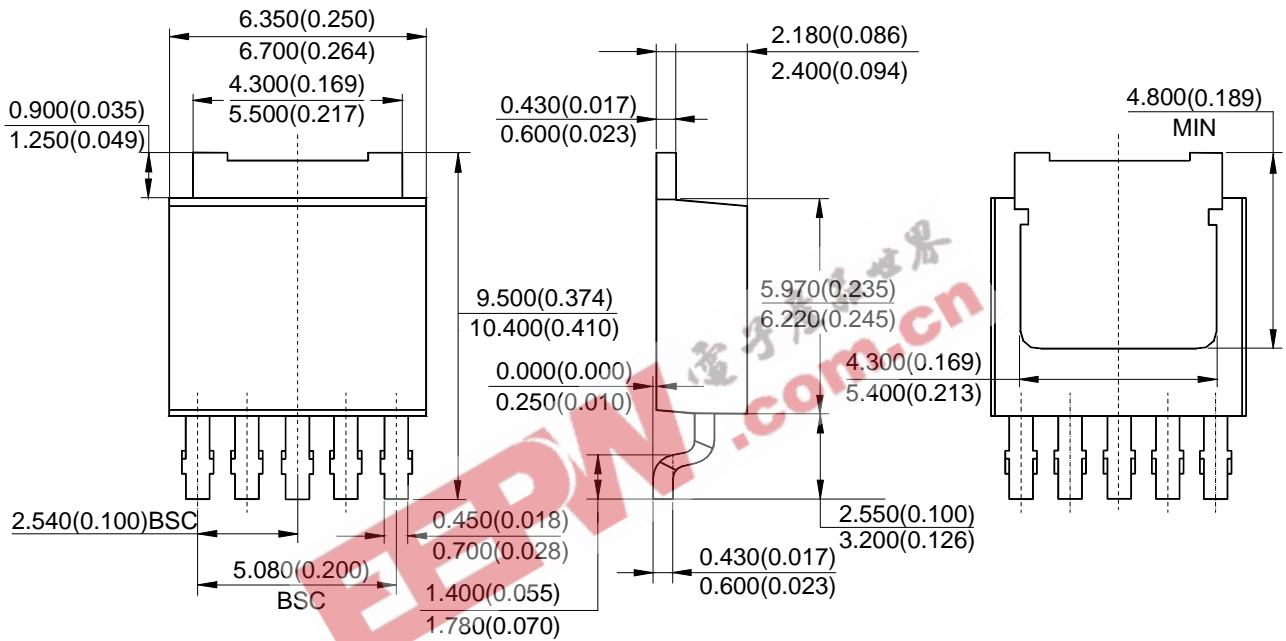



BCD Semiconductor Manufacturing Limited

<http://www.bcdsemi.com>

EPW.com.cn 电子产品世界

IMPORTANT NOTICE

BCD Semiconductor Manufacturing Limited reserves the right to make changes without further notice to any products or specifications herein. BCD Semiconductor Manufacturing Limited does not assume any responsibility for use of any its products for any particular purpose, nor does BCD Semiconductor Manufacturing Limited assume any liability arising out of the application or use of any its products or circuits. BCD Semiconductor Manufacturing Limited does not convey any license under its patent rights or other rights nor the rights of others.

MAIN SITE

BCD Semiconductor Manufacturing Limited
- Wafer Fab
Shanghai SIM-BCD Semiconductor Manufacturing Limited
800, Yi Shan Road, Shanghai 200233, China
Tel: +86-21-6485 1491, Fax: +86-21-5450 0008

BCD Semiconductor Manufacturing Limited
- IC Design Group
Advanced Analog Circuits (Shanghai) Corporation
8F, Zone B, 900, Yi Shan Road, Shanghai 200233, China
Tel: +86-21-6495 9539, Fax: +86-21-6485 9673

REGIONAL SALES OFFICE

Shenzhen Office
Shanghai SIM-BCD Semiconductor Manufacturing Co., Ltd. Shenzhen Office
Advanced Analog Circuits (Shanghai) Corporation Shenzhen Office
27B, Tower C, 2070, Middle Shen Nan Road, Shenzhen 518031, China
Tel: +86-755-8368 3987, Fax: +86-755-8368 3166

Taiwan Office
BCD Semiconductor (Taiwan) Company Limited
4F, 298-1, Rui Guang Road, Nei-Hu District, Taipei,
Taiwan
Tel: +886-2-2656 2808, Fax: +886-2-2656 2806

USA Office
BCD Semiconductor Corporation
3170 De La Cruz Blvd., Suite 105, Santa Clara,
CA 95054-2411, U.S.A
Tel: +1-408-988 6388, Fax: +1-408-988 6386