

74F538 1-of-8 Decoder with 3-STATE Outputs

General Description

The 74F538 decoder/demultiplexer accepts three Address (A_0 - A_2) input signals and decodes them to select one of eight mutually exclusive outputs. A polarity control input (P) determines whether the outputs are active LOW or active HIGH. A HIGH Signal on either of the active LOW Output Enable (\overline{OE}) inputs forces all outputs to the high impedance state. Two active HIGH and two active LOW input enables are available for easy expansion to 1-of-32 decoding with four packages, or for data demultiplexing to 1-of-8 or 1-of-16 destinations.

Features

- Output polarity control
- Data demultiplexing capability
- Multiple enables for expansion
- 3-STATE outputs

Ordering Code:

Order Number	Package Number	Package Description
74F538SC	M20B	20-Lead Small Outline Integrated Circuit (SOIC), JEDEC MS-013, 0.300 Wide
74F538SJ	M20D	20-Lead Small Outline Package (SOP), EIAJ TYPE II, 5.3mm Wide
74F538PC	N20A	20-Lead Plastic Dual-In-Line Package (PDIP), JEDEC MS-001, 0.300 Wide

Devices also available in Tape and Reel. Specify by appending the suffix letter "X" to the ordering code.

Logic Symbols

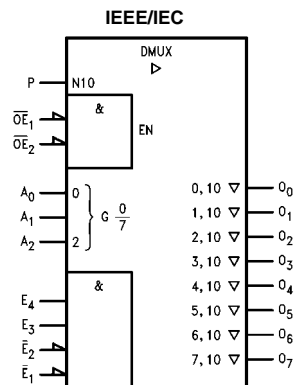
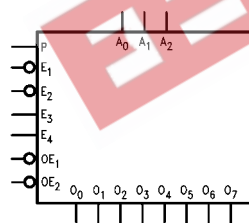

Connection Diagram

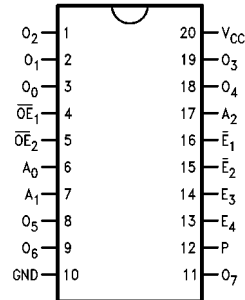

Unit Loading/Fan Out

Pin Names	Description	U.L.	Input I_{IH}/I_{IL}
		HIGH/LOW	Output I_{OH}/I_{OL}
A_0 - A_2	Address Inputs	1.0/1.0	20 μ A/-0.6 mA
$\overline{E}_1, \overline{E}_2$	Enable Inputs (Active LOW)	1.0/1.0	20 μ A/-0.6 mA
E_3, E_4	Enable Inputs (Active HIGH)	1.0/1.0	20 μ A/-0.6 mA
P	Polarity Control Input	1.0/1.0	20 μ A/-0.6 mA
$\overline{OE}_1, \overline{OE}_2$	Output Enable Inputs (Active LOW)	1.0/1.0	20 μ A/-0.6 mA
O_0 - O_7	3-STATE Outputs	150/40 (33.3)	-3 mA/24 mA (20 mA)

Truth Table

Function	Inputs									Outputs							
	\overline{OE}_1	\overline{OE}_2	\overline{E}_1	E_2	E_3	E_4	A_2	A_1	A_0	O_0	O_1	O_2	O_3	O_4	O_5	O_6	O_7
High Impedance	H	X	X	X	X	X	X	X	X	Z	Z	Z	Z	Z	Z	Z	Z
Disable	X	H	X	X	X	X	X	X	X	Z	Z	Z	Z	Z	Z	Z	Z
	L	L	H	X	X	X	X	X	X	Outputs Equal P Input							
	L	L	X	H	X	X	X	X									
	L	L	X	X	L	X	X	X									
L	L	X	X	X	L	X	X										
Active HIGH Output (P = L)	L	L	L	L	H	H	L	L	L	H	L	L	L	L	L	L	L
	L	L	L	L	H	H	L	L	H	L	H	L	L	L	L	L	L
	L	L	L	L	H	H	L	H	L	L	L	H	L	L	L	L	L
	L	L	L	L	H	H	L	H	L	L	L	L	L	H	L	L	L
	L	L	L	L	H	H	H	L	H	L	L	L	L	L	H	L	L
	L	L	L	L	H	H	H	H	L	H	L	L	L	L	L	H	L
	L	L	L	L	H	H	H	H	H	L	L	L	L	L	L	L	H
	L	L	L	L	H	H	H	H	H	H	L	L	L	L	L	L	L
Active LOW Output (P = H)	L	L	L	L	H	H	L	L	L	L	H	H	H	H	H	H	H
	L	L	L	L	H	H	L	H	L	H	H	L	H	H	H	H	H
	L	L	L	L	H	H	L	H	H	H	H	L	H	H	H	H	H
	L	L	L	L	H	H	H	L	L	H	H	H	H	L	H	H	H
	L	L	L	L	H	H	H	L	H	H	H	H	H	H	L	H	H
	L	L	L	L	H	H	H	H	L	H	H	H	H	H	H	L	H
	L	L	L	L	H	H	H	H	H	H	H	H	H	H	H	L	H
	L	L	L	L	H	H	H	H	H	H	H	H	H	H	H	H	L

H = HIGH Voltage Level
L = LOW Voltage Level
X = Immaterial
Z = High Impedance

Logic Diagram

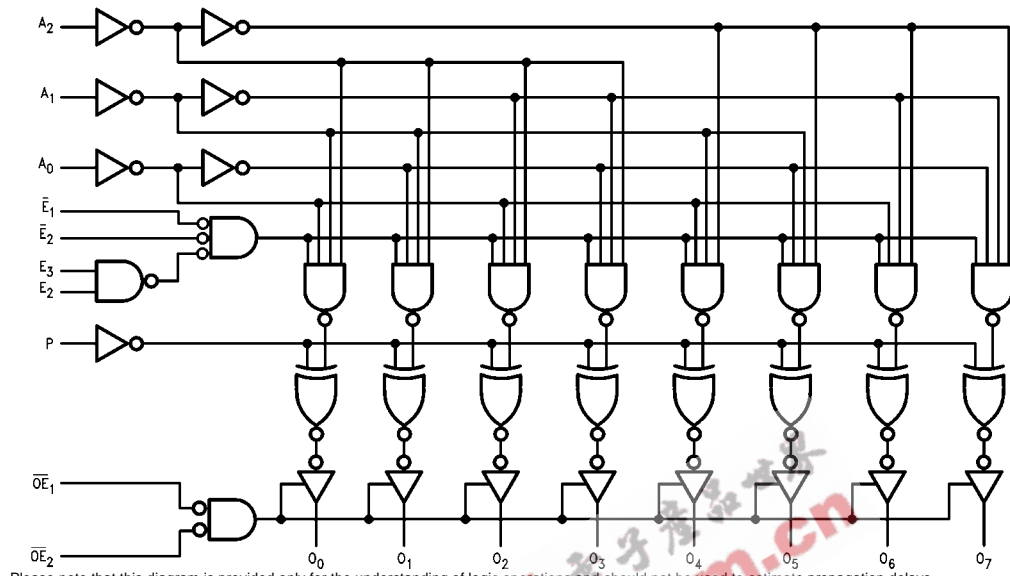

Please note that this diagram is provided only for the understanding of logic operations and should not be used to estimate propagation delays.

Absolute Maximum Ratings (Note 1)

Storage Temperature	-65°C to +150°C
Ambient Temperature under Bias	-55°C to +125°C
Junction Temperature under Bias	-55°C to +150°C
V _{CC} Pin Potential to Ground Pin	-0.5V to +7.0V
Input Voltage (Note 2)	-0.5V to +7.0V
Input Current (Note 2)	-30 mA to +5.0 mA
Voltage Applied to Output in HIGH State (with V _{CC} = 0V)	
Standard Output	-0.5V to V _{CC}
3-STATE Output	-0.5V to +5.5V
Current Applied to Output in LOW State (Max)	twice the rated I _{OL} (mA)

Recommended Operating Conditions

Free Air Ambient Temperature	0°C to +70°C
Supply Voltage	+4.5V to +5.5V

Note 1: Absolute maximum ratings are values beyond which the device may be damaged or have its useful life impaired. Functional operation under these conditions is not implied.

Note 2: Either voltage limit or current limit is sufficient to protect inputs.

DC Electrical Characteristics

Symbol	Parameter	Min	Typ	Max	Units	V _{CC}	Conditions
V _{IH}	Input HIGH Voltage	2.0			V		Recognized as a HIGH Signal
V _{IL}	Input LOW Voltage			0.8	V		Recognized as a LOW Signal
V _{CD}	Input Clamp Diode Voltage			-1.2	V	Min	I _{IN} = -18 mA
V _{OH}	Output HIGH Voltage	10% V _{CC}	2.5		V	Min	I _{OH} = -1 mA
		10% V _{CC}	2.4	I _{OH} = -3 mA			
		5% V _{CC}	2.7	I _{OH} = -1 mA			
		5% V _{CC}	2.7	I _{OH} = -3 mA			
V _{OL}	Output LOW Voltage	10% V _{CC}		0.5	V	Min	I _{OL} = 20 mA
I _{IH}	Input HIGH Current			5.0	μA	Max	V _{IN} = 2.7V
I _{BVI}	Input HIGH Current Breakdown Test			7.0	μA	Max	V _{IN} = 7.0V
I _{CEX}	Output HIGH Leakage Current			50	μA	Max	V _{OUT} = V _{CC}
V _{ID}	Input Leakage Test	4.75			V	0.0	I _{ID} = 1.9 μA All Other Pins Grounded
I _{OD}	Output Leakage Circuit Current			3.75	μA	0.0	V _{IOD} = 150 mV All Other Pins Grounded
I _{IL}	Input LOW Current			-0.6	mA	Max	V _{IN} = 0.5V
I _{OZH}	Output Leakage Current			50	μA	Max	V _{OUT} = 2.7V
I _{OZL}	Output Leakage Current			-50	μA	Max	V _{OUT} = 0.5V
I _{OS}	Output Short-Circuit Current	-60		-150	mA	Max	V _{OUT} = 0V
I _{ZZ}	Bus Drainage Test			500	μA	0.0V	V _{OUT} = 5.25V
I _{CCH}	Power Supply Current		31	45	mA	Max	V _O = HIGH
I _{CCL}	Power Supply Current		37	56	mA	Max	V _O = LOW
I _{CCZ}	Power Supply Current		37	56	mA	Max	V _O = HIGH Z

AC Electrical Characteristics							
Symbol	Parameter	T _A = +25°C V _{CC} = +5.0V C _L = 50 pF			T _A = 0°C to +70°C V _{CC} = +5.0V C _L = 50 pF		Units
		Min	Typ	Max	Min	Max	
t _{PLH}	Propagation Delay	6.0	11.0	16.0	6.0	17.0	ns
t _{PHL}	A _n to O _n	4.0	7.5	11.0	4.0	12.0	
t _{PLH}	Propagation Delay	5.0	8.5	15.0	5.0	16.0	ns
t _{PHL}	\overline{E}_1 or \overline{E}_2 to O _n	4.0	6.5	9.0	4.0	10.0	
t _{PLH}	Propagation Delay	6.0	11.0	16.0	6.0	17.0	ns
t _{PHL}	E ₃ or E ₄ to O _n	5.0	10.0	14.0	5.0	15.0	
t _{PLH}	Propagation Delay	6.0	11.5	18.0	6.0	20.0	ns
t _{PHL}	P to O _n	6.0	11.0	16.0	6.0	17.0	
t _{PZH}	Output Enable Time	3.0	5.5	10.0	3.0	11.0	ns
t _{PZL}	\overline{OE}_1 or \overline{OE}_2 to O _n	5.0	9.0	13.0	5.0	14.0	
t _{PHZ}	Output Disable Time	2.0	4.0	6.0	2.0	7.0	
t _{PLZ}	\overline{OE}_1 or \overline{OE}_2 to O _n	3.0	5.0	8.0	3.0	9.0	

EEPW 电子产品世界 .com.cn

Physical Dimensions inches (millimeters) unless otherwise noted

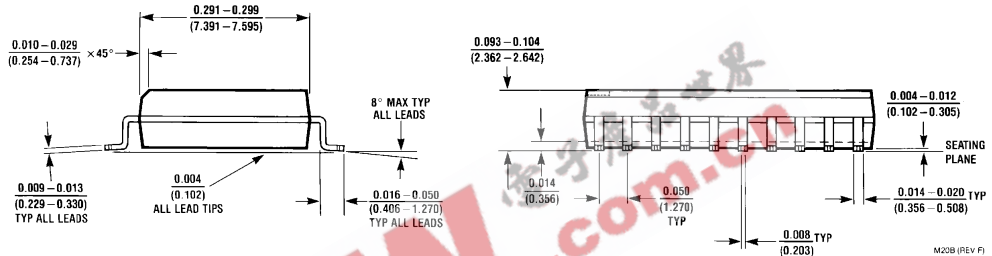
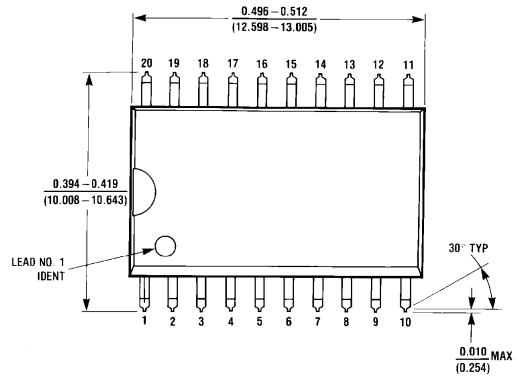

**20-Lead Small Outline Integrated Circuit (SOIC), JEDEC MS-013, 0.300 Wide
Package Number M20B**

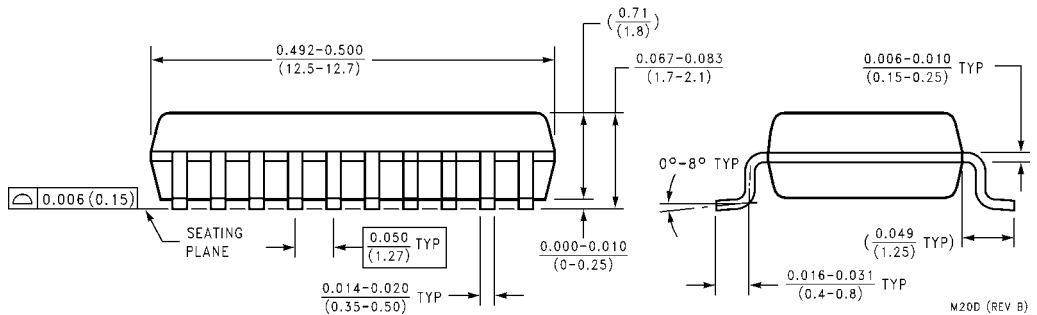
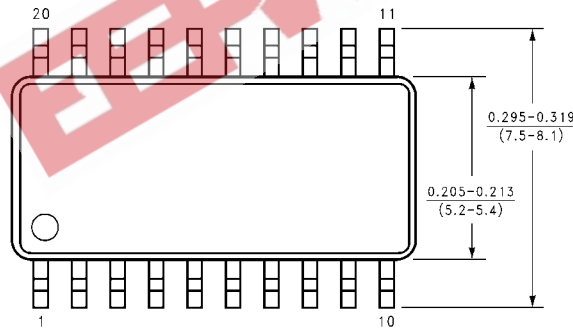

**20-Lead Small Outline Package (SOP), EIAJ TYPE II, 5.3mm Wide
Package Number M20D**

Physical Dimensions inches (millimeters) unless otherwise noted (Continued)

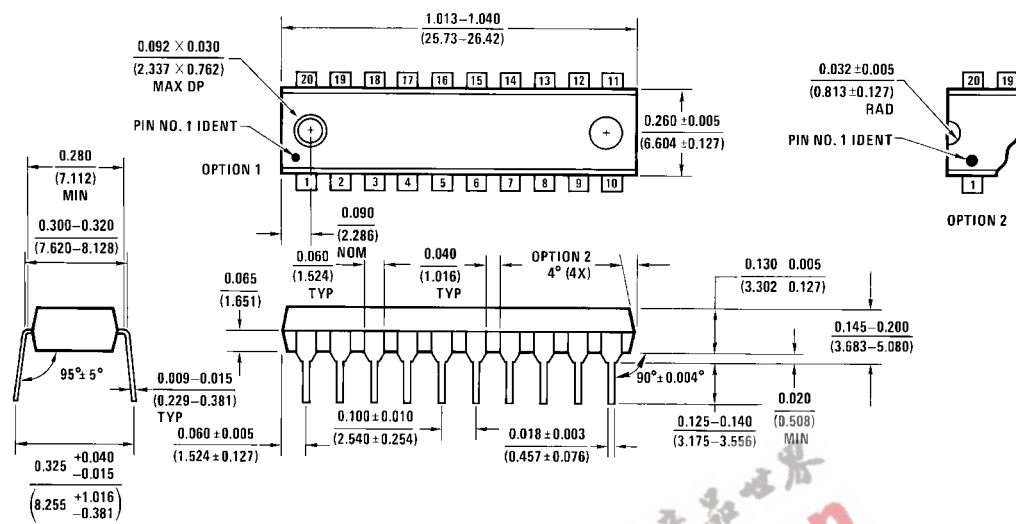

20-Lead Plastic Dual-In-Line Package (PDIP), JEDEC MS-001, 0.300 Wide
Package Number N20A

Fairchild does not assume any responsibility for use of any circuitry described, no circuit patent licenses are implied and Fairchild reserves the right at any time without notice to change said circuitry and specifications.

LIFE SUPPORT POLICY

FAIRCHILD'S PRODUCTS ARE NOT AUTHORIZED FOR USE AS CRITICAL COMPONENTS IN LIFE SUPPORT DEVICES OR SYSTEMS WITHOUT THE EXPRESS WRITTEN APPROVAL OF THE PRESIDENT OF FAIRCHILD SEMICONDUCTOR CORPORATION. As used herein:

1. Life support devices or systems are devices or systems which, (a) are intended for surgical implant into the body, or (b) support or sustain life, and (c) whose failure to perform when properly used in accordance with instructions for use provided in the labeling, can be reasonably expected to result in a significant injury to the user.
2. A critical component in any component of a life support device or system whose failure to perform can be reasonably expected to cause the failure of the life support device or system, or to affect its safety or effectiveness.

www.fairchildsemi.com