



DUAL 1-OF-4 DECODER/ DEMULTIPLEXER

The SN54/74LS155 and SN54/74LS156 are high speed Dual 1-of-4 Decoder/Demultiplexers. These devices have two decoders with common 2-bit Address inputs and separate gated Enable inputs. Decoder "a" has an Enable gate with one active HIGH and one active LOW input. Decoder "b" has two active LOW Enable inputs. If the Enable functions are satisfied, one output of each decoder will be LOW as selected by the address inputs. The LS156 has open collector outputs for wired-OR (DOT-AND) decoding and function generator applications.

The LS155 and LS156 are fabricated with the Schottky barrier diode process for high speed and are completely compatible with all Motorola TTL families.

- Schottky Process for High Speed
- Multifunction Capability
- Common Address Inputs
- True or Complement Data Demultiplexing
- Input Clamp Diodes Limit High Speed Termination Effects
- ESD > 3500 Volts

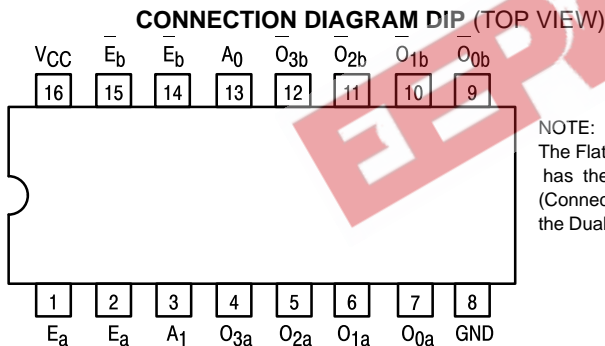

NOTE:
The Flatpak version has the same pinouts (Connection Diagram) as the Dual In-Line Package.

PIN NAMES

| | |
|-------------|-----------------------------|
| A_0, A_1 | Address Inputs |
| E_a, E_b | Enable (Active LOW) Inputs |
| \bar{E}_a | Enable (Active HIGH) Input |
| O_0-O_3 | Active LOW Outputs (Note b) |

LOADING (Note a)

| HIGH | LOW |
|----------|--------------|
| 0.5 U.L. | 0.25 U.L. |
| 0.5 U.L. | 0.25 U.L. |
| 0.5 U.L. | 0.25 U.L. |
| 10 U.L. | 5 (2.5) U.L. |

NOTES:

- a) 1 TTL Unit Load (U.L.) = 40 μ A HIGH/1.6 mA LOW.
 b) The Output LOW drive factor is 2.5 U.L. for Military (54) and 5 U.L. for Commercial (74) Temperature Ranges. The HIGH level drive for the LS156 must be established by an external resistor.

SN54/74LS155 SN54/74LS156

DUAL 1-OF-4 DECODER/ DEMULTIPLEXER

LS156-OPEN-COLLECTOR
LOW POWER SCHOTTKY

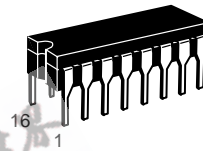

J SUFFIX
CERAMIC
CASE 620-09

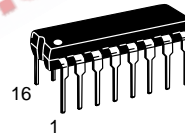

N SUFFIX
PLASTIC
CASE 648-08

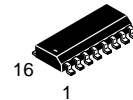

D SUFFIX
SOIC
CASE 751B-03

ORDERING INFORMATION

| | |
|------------|---------|
| SN54LSXXXJ | Ceramic |
| SN74LSXXXN | Plastic |
| SN74LSXXXD | SOIC |

LOGIC SYMBOL

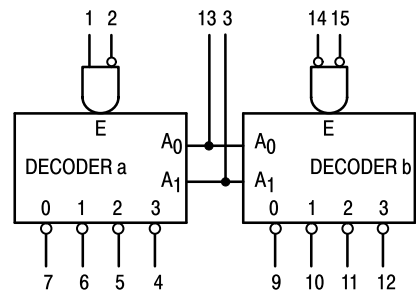

V_{CC} = PIN 16
GND = PIN 8

SN54/74LS155 • SN54/74LS156

LOGIC DIAGRAM

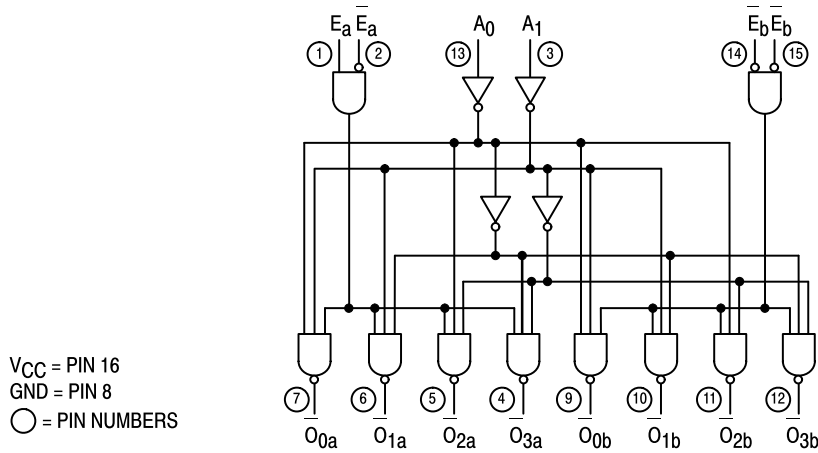

FUNCTIONAL DESCRIPTION

The LS155 and LS156 are Dual 1-of-4 Decoder/Demultiplexers with common Address inputs and separate gated Enable inputs. When enabled, each decoder section accepts the binary weighted Address inputs (A_0, A_1) and provides four mutually exclusive active LOW outputs ($O_0 - O_3$). If the Enable requirements of each decoder are not met, all outputs of that decoder are HIGH.

Each decoder section has a 2-input enable gate. The enable gate for Decoder "a" requires one active HIGH input and one active LOW input ($E_a \cdot \bar{E}_a$). In demultiplexing applications, Decoder "a" can accept either true or complemented data by using the E_a or \bar{E}_a inputs respectively. The enable gate for Decoder "b" requires two active LOW inputs ($\bar{E}_b \cdot E_b$). The LS155 or LS156 can be used as a 1-of-8 Decoder/Demultiplexer by tying E_a to \bar{E}_b and relabeling the common connection as (A_2). The other E_b and E_a are connected together to form the common enable.

The LS155 and LS156 can be used to generate all four minterms of two variables. These four minterms are useful in some applications replacing multiple gate functions as shown in Fig. a. The LS156 has the further advantage of being able to

AND the minterm functions by tying outputs together. Any number of terms can be wired-AND as shown below.

$$f = (\bar{E}_a + A_0 + A_1) \cdot (E_a + \bar{A}_0 + A_1) \cdot (E_b + A_0 + \bar{A}_1) \cdot (\bar{E}_b + \bar{A}_0 + A_1)$$

where $E = E_a + \bar{E}_a$; $\bar{E} = E_b + \bar{E}_b$

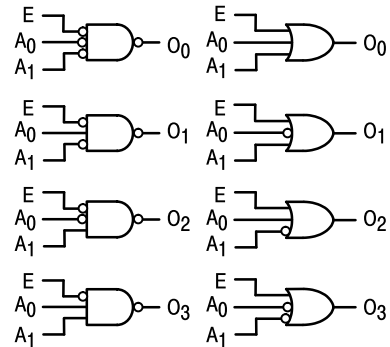

Figure a

TRUTH TABLE

| ADDRESS | | ENABLE "a" | | OUTPUT "a" | | | | ENABLE "b" | | OUTPUT "b" | | | |
|---------|-------|------------|-------------|------------|-------|-------|-------|-------------|-------|------------|-------|-------|-------|
| A_0 | A_1 | E_a | \bar{E}_a | O_0 | O_1 | O_2 | O_3 | \bar{E}_b | E_b | O_0 | O_1 | O_2 | O_3 |
| X | X | L | X | H | H | H | H | H | X | H | H | H | H |
| X | X | X | H | H | H | H | H | X | H | H | H | H | H |
| L | L | H | L | L | H | H | H | L | L | L | H | H | H |
| H | L | H | L | H | L | H | H | L | L | H | L | H | H |
| L | H | H | L | H | H | L | H | L | L | H | H | L | H |
| H | H | H | L | H | H | H | L | L | L | H | H | H | L |

H = HIGH Voltage Level
 L = LOW Voltage Level
 X = Don't Care

SN54/74LS155

GUARANTEED OPERATING RANGES

| Symbol | Parameter | | Min | Typ | Max | Unit |
|-----------------|-------------------------------------|----------|-------------|------------|-------------|------|
| V _{CC} | Supply Voltage | 54 74 | 4.5 4.75 | 5.0 5.0 | 5.5 5.25 | V |
| T _A | Operating Ambient Temperature Range | 54 74 | -55 0 | 25 25 | 125 70 | °C |
| I _{OH} | Output Current — High | 54, 74 | | | -0.4 | mA |
| I _{OL} | Output Current — Low | 54 74 | | | 4.0 8.0 | mA |

DC CHARACTERISTICS OVER OPERATING TEMPERATURE RANGE (unless otherwise specified)

| Symbol | Parameter | Limits | | | Unit | Test Conditions |
|-----------------|--------------------------------|--------|-------|------|------|--|
| | | Min | Typ | Max | | |
| V _{IH} | Input HIGH Voltage | 2.0 | | | V | Guaranteed Input HIGH Voltage for All Inputs |
| V _{IL} | Input LOW Voltage | 54 | | 0.7 | V | Guaranteed Input LOW Voltage for All Inputs |
| | | 74 | | 0.8 | | |
| V _{IK} | Input Clamp Diode Voltage | | -0.65 | -1.5 | V | V _{CC} = MIN, I _{IN} = -18 mA |
| V _{OH} | Output HIGH Voltage | 54 | 2.5 | 3.5 | V | V _{CC} = MIN, I _{OH} = MAX, V _{IN} = V _{IH} or V _{IL} per Truth Table |
| | | 74 | 2.7 | 3.5 | V | |
| V _{OL} | Output LOW Voltage | 54, 74 | 0.25 | 0.4 | V | I _{OL} = 4.0 mA |
| | | 74 | 0.35 | 0.5 | V | I _{OL} = 8.0 mA |
| I _{IH} | Input HIGH Current | | | 20 | μA | V _{CC} = MAX, V _{IN} = 2.7 V |
| | | | | 0.1 | mA | V _{CC} = MAX, V _{IN} = 7.0 V |
| I _{IL} | Input LOW Current | | | -0.4 | mA | V _{CC} = MAX, V _{IN} = 0.4 V |
| I _{OS} | Short Circuit Current (Note 1) | -20 | | -100 | mA | V _{CC} = MAX |
| I _{CC} | Power Supply Current | | | 10 | mA | V _{CC} = MAX |

Note 1: Not more than one output should be shorted at a time, nor for more than 1 second.

AC CHARACTERISTICS (T_A = 25°C)

| Symbol | Parameter | Limits | | | Unit | Test Conditions |
|--------------------------------------|--|--------|----------|----------|------|---|
| | | Min | Typ | Max | | |
| t _{PLH} t _{PHL} | Propagation Delay Address, E _a or E _b to Output | | 10 19 | 15 30 | ns | V _{CC} = 5.0 V C _L = 15 pF |
| t _{PLH} t _{PHL} | Propagation Delay Address to Output | | 17 19 | 26 30 | ns | |
| t _{PLH} t _{PHL} | Propagation Delay E _a to Output | | 18 18 | 27 27 | ns | |

AC WAVEFORMS

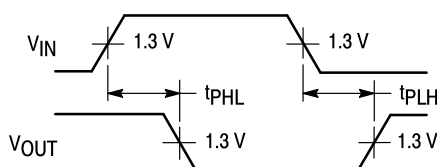

Figure 1

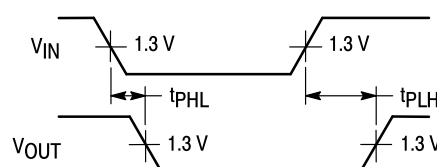

Figure 2

SN54/74LS156

GUARANTEED OPERATING RANGES

| Symbol | Parameter | | Min | Typ | Max | Unit |
|-----------------|-------------------------------------|----------|-------------|------------|-------------|------|
| V _{CC} | Supply Voltage | 54 74 | 4.5 4.75 | 5.0 5.0 | 5.5 5.25 | V |
| T _A | Operating Ambient Temperature Range | 54 74 | -55 0 | 25 25 | 125 70 | °C |
| V _{OH} | Output Voltage — High | 54, 74 | | | 5.5 | V |
| I _{OL} | Output Current — Low | 54 74 | | | 4.0 8.0 | mA |

DC CHARACTERISTICS OVER OPERATING TEMPERATURE RANGE (unless otherwise specified)

| Symbol | Parameter | Limits | | | Unit | Test Conditions |
|-----------------|---------------------------|--------|-------|------|------|---|
| | | Min | Typ | Max | | |
| V _{IH} | Input HIGH Voltage | 2.0 | | | V | Guaranteed Input HIGH Voltage for All Inputs |
| V _{IL} | Input LOW Voltage | 54 | | 0.7 | V | Guaranteed Input LOW Voltage for All Inputs |
| | | 74 | | 0.8 | | |
| V _{IK} | Input Clamp Diode Voltage | | -0.65 | -1.5 | V | V _{CC} = MIN, I _{IN} = -18 mA |
| I _{OH} | Output HIGH Current | 54, 74 | | 100 | μA | V _{CC} = MIN, V _{OH} = MAX |
| V _{OL} | Output LOW Voltage | 54, 74 | 0.25 | 0.4 | V | I _{OL} = 4.0 mA |
| | | 74 | 0.35 | 0.5 | V | I _{OL} = 8.0 mA |
| I _{IH} | Input HIGH Current | | | 20 | μA | V _{CC} = MAX, V _{IN} = 2.7 V |
| | | | | 0.1 | mA | V _{CC} = MAX, V _{IN} = 7.0 V |
| I _{IL} | Input LOW Current | | | -0.4 | mA | V _{CC} = MAX, V _{IN} = 0.4 V |
| I _{CC} | Power Supply Current | | | 10 | mA | V _{CC} = MAX |

AC CHARACTERISTICS (T_A = 25°C)

| Symbol | Parameter | Limits | | | Unit | Test Conditions |
|--------------------------------------|--|--------|----------|----------|------|--|
| | | Min | Typ | Max | | |
| t _{PLH} t _{PHL} | Propagation Delay Address, E _a or E _b to Output | | 25 34 | 40 51 | ns | V _{CC} = 5.0 V C _L = 15 pF R _L = 2.0 kΩ |
| t _{PLH} t _{PHL} | Propagation Delay Address to Output | | 31 34 | 46 51 | ns | |
| t _{PLH} t _{PHL} | Propagation Delay E _a to Output | | 32 32 | 48 48 | ns | |

AC WAVEFORMS

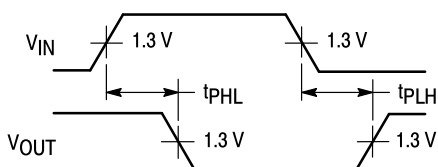

Figure 1

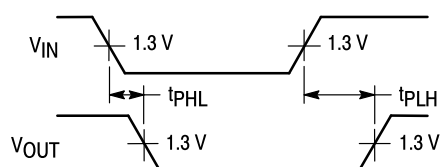
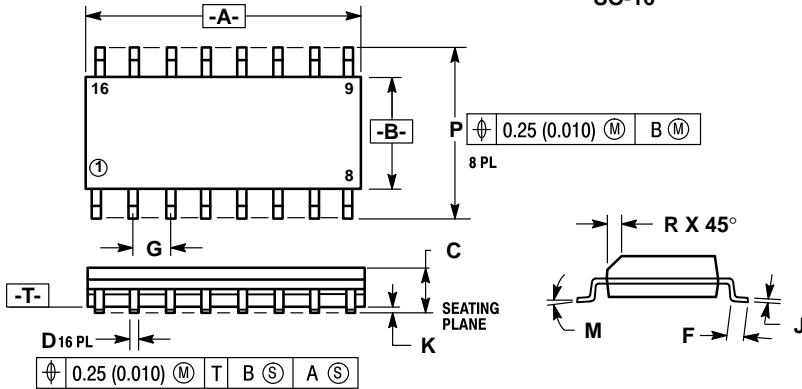

Figure 2

**Case 751B-03 D Suffix
16-Pin Plastic
SO-16**



- NOTES:
1. DIMENSIONING AND TOLERANCING PER ANSI Y14.5M, 1982.
 2. CONTROLLING DIMENSION: MILLIMETER.
 3. DIMENSION A AND B DO NOT INCLUDE MOLD PROTRUSION.
 4. MAXIMUM MOLD PROTRUSION 0.15 (0.006) PER SIDE.
 5. 751B-01 IS OBSOLETE, NEW STANDARD 751B-03.

| DIM | MILLIMETERS | | INCHES | |
|-----|-------------|-------|-----------|-------|
| | MIN | MAX | MIN | MAX |
| A | 9.80 | 10.00 | 0.386 | 0.393 |
| B | 3.80 | 4.00 | 0.150 | 0.157 |
| C | 1.35 | 1.75 | 0.054 | 0.068 |
| D | 0.35 | 0.49 | 0.014 | 0.019 |
| F | 0.40 | 1.25 | 0.016 | 0.049 |
| G | 1.27 BSC | | 0.050 BSC | |
| J | 0.19 | 0.25 | 0.008 | 0.009 |
| K | 0.10 | 0.25 | 0.004 | 0.009 |
| M | 0° | 7° | 0° | 7° |
| P | 5.80 | 6.20 | 0.229 | 0.244 |
| R | 0.25 | 0.50 | 0.010 | 0.019 |

**Case 648-08 N Suffix
16-Pin Plastic**

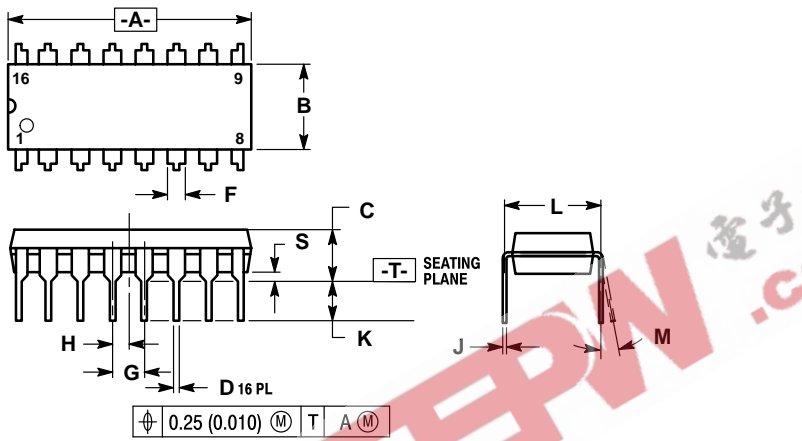

- NOTES:
1. DIMENSIONING AND TOLERANCING PER ANSI Y14.5M, 1982.
 2. CONTROLLING DIMENSION: INCH.
 3. DIMENSION "L" TO CENTER OF LEADS WHEN FORMED PARALLEL.
 4. DIMENSION "B" DOES NOT INCLUDE MOLD FLASH.
 5. ROUNDED CORNERS OPTIONAL.
 6. 648-01 THRU -07 OBSOLETE, NEW STANDARD 648-08.

| DIM | MILLIMETERS | | INCHES | |
|-----|-------------|-------|-----------|-------|
| | MIN | MAX | MIN | MAX |
| A | 18.80 | 19.55 | 0.740 | 0.770 |
| B | 6.35 | 6.85 | 0.250 | 0.270 |
| C | 3.69 | 4.44 | 0.145 | 0.175 |
| D | 0.39 | 0.53 | 0.015 | 0.021 |
| F | 1.02 | 1.77 | 0.040 | 0.070 |
| G | 2.54 BSC | | 0.100 BSC | |
| H | 1.27 BSC | | 0.050 BSC | |
| J | 0.21 | 0.38 | 0.008 | 0.015 |
| K | 2.80 | 3.30 | 0.110 | 0.130 |
| L | 7.50 | 7.74 | 0.295 | 0.305 |
| M | 0° | 10° | 0° | 10° |
| S | 0.51 | 1.01 | 0.020 | 0.040 |

**Case 620-09 J Suffix
16-Pin Ceramic Dual In-Line**

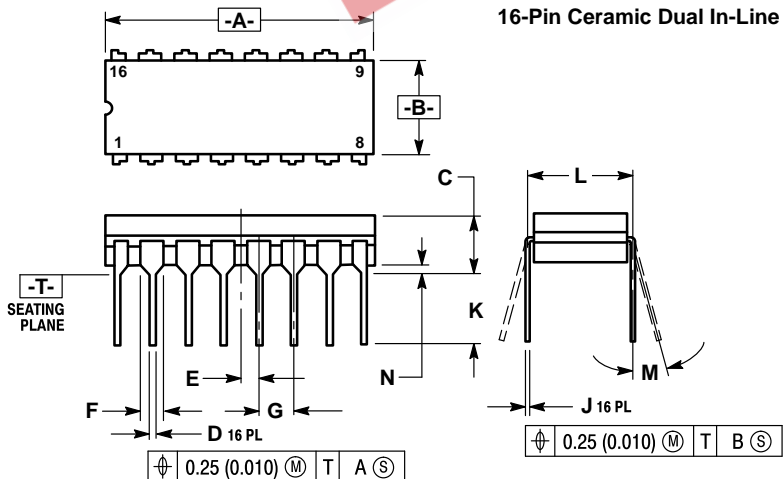

- NOTES:
1. DIMENSIONING AND TOLERANCING PER ANSI Y14.5M, 1982.
 2. CONTROLLING DIMENSION: INCH.
 3. DIMENSION L TO CENTER OF LEAD WHEN FORMED PARALLEL.
 4. DIM F MAY NARROW TO 0.76 (0.030) WHERE THE LEAD ENTERS THE CERAMIC BODY.
 5. 620-01 THRU -08 OBSOLETE, NEW STANDARD 620-09.

| DIM | MILLIMETERS | | INCHES | |
|-----|-------------|-------|-----------|-------|
| | MIN | MAX | MIN | MAX |
| A | 19.05 | 19.55 | 0.750 | 0.770 |
| B | 6.10 | 7.36 | 0.240 | 0.290 |
| C | — | 4.19 | — | 0.165 |
| D | 0.39 | 0.53 | 0.015 | 0.021 |
| E | 1.27 BSC | | 0.050 BSC | |
| F | 1.40 | 1.77 | 0.055 | 0.070 |
| G | 2.54 BSC | | 0.100 BSC | |
| J | 0.23 | 0.27 | 0.009 | 0.011 |
| K | — | 5.08 | — | 0.200 |
| L | 7.62 BSC | | 0.300 BSC | |
| M | 0° | 15° | 0° | 15° |
| N | 0.39 | 0.88 | 0.015 | 0.035 |

EEPW 电子產品世界
.com.cn

Motorola reserves the right to make changes without further notice to any products herein. Motorola makes no warranty, representation or guarantee regarding the suitability of its products for any particular purpose, nor does Motorola assume any liability arising out of the application or use of any product or circuit, and specifically disclaims any and all liability, including without limitation consequential or incidental damages. "Typical" parameters can and do vary in different applications. All operating parameters, including "Typicals" must be validated for each customer application by customer's technical experts. Motorola does not convey any license under its patent rights nor the rights of others. Motorola products are not designed, intended, or authorized for use as components in systems intended for surgical implant into the body, or other applications intended to support or sustain life, or for any other application in which the failure of the Motorola product could create a situation where personal injury or death may occur. Should Buyer purchase or use Motorola products for any such unintended or unauthorized application, Buyer shall indemnify and hold Motorola and its officers, employees, subsidiaries, affiliates, and distributors harmless against all claims, costs, damages, and expenses, and reasonable attorney fees arising out of, directly or indirectly, any claim of personal injury or death associated with such unintended or unauthorized use, even if such claim alleges that Motorola was negligent regarding the design or manufacture of the part. Motorola and  are registered trademarks of Motorola, Inc. Motorola, Inc. is an Equal Opportunity/Affirmative Action Employer.

Literature Distribution Centers:

USA: Motorola Literature Distribution; P.O. Box 20912; Phoenix, Arizona 85036.

EUROPE: Motorola Ltd.; European Literature Centre; 88 Tanners Drive, Blakelands, Milton Keynes, MK14 5BP, England.

JAPAN: Nippon Motorola Ltd.; 4-32-1, Nishi-Gotanda, Shinagawa-ku, Tokyo 141, Japan.

ASIA PACIFIC: Motorola Semiconductors H.K. Ltd.; Silicon Harbour Center, No. 2 Dai King Street, Tai Po Industrial Estate, Tai Po, N.T., Hong Kong.

