

ADC104S101

4 Channel, 1 MSPS, 10-Bit A/D Converter

General Description

The ADC104S101 is a low-power, four-channel CMOS 10-bit analog-to-digital converter with a high-speed serial interface. Unlike the conventional practice of specifying performance at a single sample rate only, the ADC104S101 is fully specified over a sample rate range of 500 kSPS to 1 MSPS. The converter is based on a successive-approximation register architecture with an internal track-and-hold circuit. It can be configured to accept up to four input signals at inputs IN1 through IN4.

The output serial data is straight binary, and is compatible with several standards, such as SPI™, QSPI™, MICROWIRE, and many common DSP serial interfaces.

The ADC104S101 operates with a single supply, that can range from +2.7V to +5.25V. Normal power consumption using a +3V or +5V supply is 3.9 mW and 11.4 mW, respectively. The power-down feature reduces the power consumption to just 0.12 μW using a +3.6V supply, or 0.47 μW using a +5.5V supply.

The ADC104S101 is packaged in a 10-lead MSOP package. Operation over the industrial temperature range of -40°C to +85°C is guaranteed.

Features

- Specified over a range of sample rates.
- Four input channels
- Variable power management
- Single power supply with 2.7V - 5.25V range

Key Specifications

- DNL +0.26/-0.16 LSB (typ)
- INL +0.4/-0.1 LSB (typ)
- SNR 61.7 dB (typ)
- Power Consumption
 - 3V Supply 3.9 mW (typ)
 - 5V Supply 11.4 mW (typ)

Applications

- Portable Systems
- Remote Data Acquisition
- Instrumentation and Control Systems

Pin-Compatible Alternatives by Resolution and Speed

All devices are fully pin and function compatible.

| Resolution | Specified for Sample Rates of: | | |
|------------|--------------------------------|-----------------|--------------------|
| | 50 to 200 kSPS | 200 to 500 kSPS | 500 kSPS to 1 MSPS |
| 12-bit | ADC124S021 | ADC124S051 | ADC124S101 |
| 10-bit | ADC104S021 | ADC104S051 | ADC104S101 |
| 8-bit | ADC084S021 | ADC084S051 | ADC084S101 |

Connection Diagram

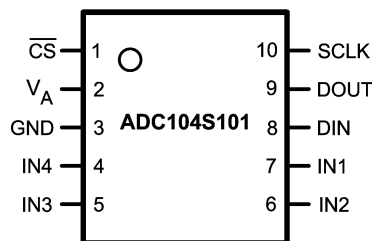

20125005

TRI-STATE® is a trademark of National Semiconductor Corporation
 QSPI™ and SPI™ are trademarks of Motorola, Inc.

Ordering Information

| Order Code | Temperature Range | Description | Top Mark |
|-----------------|-------------------|-----------------------------------|----------|
| ADC104S101C1MM | -40°C to +85°C | 10-Lead MSOP Package | X26C |
| ADC104S101C1MMX | -40°C to +85°C | 10-Lead MSOP Package, Tape & Reel | X26C |
| ADC104S101EVAL | | Evaluation Board | |

Block Diagram

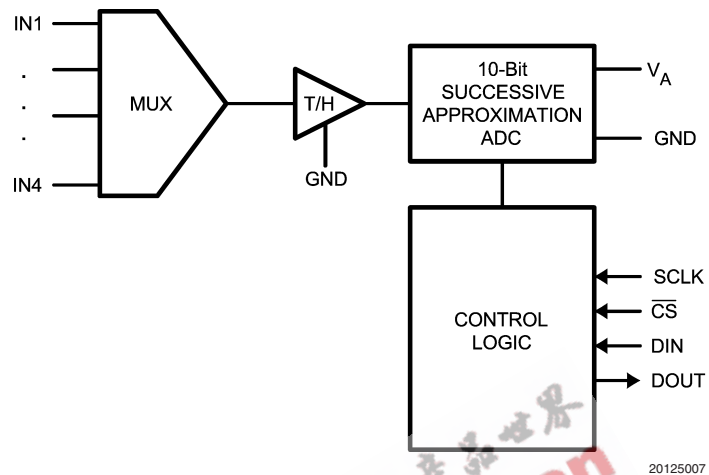

Pin Descriptions and Equivalent Circuits

| Pin No. | Symbol | Description |
|---------------------|-----------------|-----------------------------------------------------------------------------------------------------------------------------------------------------------------------------------------------------------------|
| ANALOG I/O | | |
| 4-7 | IN1 to IN4 | Analog inputs. These signals can range from 0V to V_A . |
| DIGITAL I/O | | |
| 10 | SCLK | Digital clock input. This clock directly controls the conversion and readout processes. |
| 9 | DOUT | Digital data output. The output samples are clocked out of this pin on falling edges of the SCLK pin. |
| 8 | DIN | Digital data input. The ADC104S101's Control Register is loaded through this pin on rising edges of the SCLK pin. |
| 1 | \overline{CS} | Chip select. On the falling edge of \overline{CS} , a conversion process begins. Conversions continue as long as \overline{CS} is held low. |
| POWER SUPPLY | | |
| 2 | V_A | Positive supply pin. This pin should be connected to a quiet +2.7V to +5.25V source and bypassed to GND with a 1 μ F capacitor and a 0.1 μ F monolithic capacitor located within 1 cm of the power pin. |
| 3 | GND | The ground return for the analog supply and signals. |

Absolute Maximum Ratings (Notes 1, 2)

If Military/Aerospace specified devices are required, please contact the National Semiconductor Sales Office/Distributors for availability and specifications.

| | |
|-----------------------------------------------|---------------------------------------------|
| Supply Voltage V_A | -0.3V to 6.5V |
| Voltage on Any Pin to GND | -0.3V to $V_A + 0.3V$ |
| Input Current at Any Pin (Note 3) | ± 10 mA |
| Package Input Current (Note 3) | ± 20 mA |
| Power Consumption at $T_A = 25^\circ\text{C}$ | See (Note 4) |
| ESD Susceptibility (Note 5) | |
| Human Body Model | 2500V |
| Machine Model | 250V |
| Junction Temperature | $+150^\circ\text{C}$ |
| Storage Temperature | -65°C to $+150^\circ\text{C}$ |

Operating Ratings (Notes 1, 2)

| | |
|----------------------------------|-----------------------------------------------------|
| Operating Temperature Range | $-40^\circ\text{C} \leq T_A \leq +85^\circ\text{C}$ |
| V_A Supply Voltage | +2.7V to +5.25V |
| Digital Input Pins Voltage Range | -0.3V to V_A |
| Clock Frequency | 0.8 MHz to 16 MHz |
| Analog Input Voltage | 0V to V_A |

Package Thermal Resistance

| Package | θ_{JA} |
|--------------|--------------------------------|
| 10-lead MSOP | $190^\circ\text{C} / \text{W}$ |

Soldering process must comply with National Semiconductor's Reflow Temperature Profile specifications. Refer to www.national.com/packaging. (Note 6)

ADC104S101 Converter Electrical Characteristics (Note 9)

The following specifications apply for $V_A = +2.7V$ to $5.25V$, $GND = 0V$, $C_L = 50$ pF, $f_{SCLK} = 8$ MHz to 16 MHz, $f_{SAMPLE} = 500$ kSPS to 1 MSPS, unless otherwise noted. **Boldface limits apply for $T_A = T_{MIN}$ to T_{MAX}** ; all other limits $T_A = 25^\circ\text{C}$.

| Symbol | Parameter | Conditions | Typical | Limits (Note 7) | Units |
|------------------------------------------|------------------------------------------------|---------------------------------------------------------------|---------|-----------------------------|------------|
| STATIC CONVERTER CHARACTERISTICS | | | | | |
| | Resolution with No Missing Codes | | | 10 | Bits |
| INL | Integral Non-Linearity | | +0.4 | +0.7 | LSB (max) |
| | | | -0.1 | -0.5 | LSB (min) |
| DNL | Differential Non-Linearity | | +0.26 | +0.6 | LSB (max) |
| | | | -0.16 | -0.6 | LSB (min) |
| V_{OFF} | Offset Error | | +0.19 | ± 0.6 | LSB (max) |
| OEM | Channel to Channel Offset Error Match | | 0.02 | ± 0.6 | LSB (max) |
| FSE | Full_Scale Error | | -0.15 | ± 0.7 | LSB (max) |
| FSEM | Channel to Channel Full_Scale Error Match | | 0.02 | ± 0.5 | LSB (max) |
| DYNAMIC CONVERTER CHARACTERISTICS | | | | | |
| SINAD | Signal-to-Noise Plus Distortion Ratio | $V_A = +2.7V$ to $5.25V$ $f_{IN} = 40.3$ kHz, -0.02 dBFS | 61.6 | 61 | dB (min) |
| SNR | Signal-to-Noise Ratio | $V_A = +2.7V$ to $5.25V$ $f_{IN} = 40.3$ kHz, -0.02 dBFS | 61.7 | 61.3 | dB (min) |
| THD | Total Harmonic Distortion | $V_A = +2.7V$ to $5.25V$ $f_{IN} = 40.3$ kHz, -0.02 dBFS | -82 | -72 | dB (max) |
| SFDR | Spurious-Free Dynamic Range | $V_A = +2.7V$ to $5.25V$ $f_{IN} = 40.3$ kHz, -0.02 dBFS | 83 | 75 | dB (min) |
| ENOB | Effective Number of Bits | $V_A = +2.7V$ to $5.25V$ $f_{IN} = 40.3$ kHz, -0.02 dBFS | 9.9 | 9.8 | Bits (min) |
| | Channel-to-Channel Crosstalk | $V_A = +5.25V$ $f_{IN} = 40.3$ kHz | -78 | | dB |
| IMD | Intermodulation Distortion, Second Order Terms | $V_A = +5.25V$ $f_a = 40.161$ kHz, $f_b = 41.015$ kHz | -82 | | dB |
| | Intermodulation Distortion, Third Order Terms | $V_A = +5.25V$ $f_a = 40.161$ kHz, $f_b = 41.015$ kHz | -81 | | dB |
| FPBW | -3 dB Full Power Bandwidth | $V_A = +5V$ | 11 | | MHz |
| | | $V_A = +3V$ | 8 | | MHz |

ADC104S101 Converter Electrical Characteristics (Note 9) (Continued)

The following specifications apply for $V_A = +2.7V$ to $5.25V$, $GND = 0V$, $C_L = 50$ pF, $f_{SCLK} = 8$ MHz to 16 MHz, $f_{SAMPLE} = 500$ kSPS to 1 MSPS, unless otherwise noted. **Boldface limits apply for $T_A = T_{MIN}$ to T_{MAX}** ; all other limits $T_A = 25^\circ C$.

| Symbol | Parameter | Conditions | Typical | Limits (Note 7) | Units |
|----------------------------------------------------------------|----------------------------------------------------------------------|--------------------------------------------------------------|---------------------------|-------------------------------|---------------|
| ANALOG INPUT CHARACTERISTICS | | | | | |
| V_{IN} | Input Range | | 0 to V_A | | V |
| I_{DCL} | DC Leakage Current | | | ± 1 | μA (max) |
| C_{INA} | Input Capacitance | Track Mode | 33 | | pF |
| | | Hold Mode | 3 | | pF |
| DIGITAL INPUT CHARACTERISTICS | | | | | |
| V_{IH} | Input High Voltage | $V_A = +5.25V$ | | 2.4 | V (min) |
| | | $V_A = +3.6V$ | | 2.1 | V (min) |
| V_{IL} | Input Low Voltage | | | 0.8 | V (max) |
| I_{IN} | Input Current | $V_{IN} = 0V$ or V_A | ± 0.2 | ± 10 | μA (max) |
| C_{IND} | Digital Input Capacitance | | 2 | 4 | pF (max) |
| DIGITAL OUTPUT CHARACTERISTICS | | | | | |
| V_{OH} | Output High Voltage | $I_{SOURCE} = 200 \mu A$ | $V_A - 0.03$ | $V_A - 0.5$ | V (min) |
| | | $I_{SOURCE} = 1$ mA | $V_A - 0.1$ | | V |
| V_{OL} | Output Low Voltage | $I_{SINK} = 200 \mu A$ | 0.03 | 0.4 | V (max) |
| | | $I_{SINK} = 1$ mA | 0.1 | | V |
| I_{OZH}, I_{OZL} | TRI-STATE® Leakage Current | | ± 0.01 | ± 1 | μA (max) |
| C_{OUT} | TRI-STATE® Output Capacitance | | 2 | 4 | pF (max) |
| | Output Coding | | Straight (Natural) Binary | | |
| POWER SUPPLY CHARACTERISTICS ($C_L = 10$ pF) | | | | | |
| V_A | Supply Voltage | | | 2.7 | V (min) |
| | | | | 5.25 | V (max) |
| I_A | Supply Current, Normal Mode (Operational, \overline{CS} low) | $V_A = +5.25V$, $f_{SAMPLE} = 1$ MSPS, $f_{IN} = 40$ kHz | 2.18 | 2.7 | mA (max) |
| | | $V_A = +3.6V$, $f_{SAMPLE} = 1$ MSPS, $f_{IN} = 40$ kHz | 1.08 | 1.3 | mA (max) |
| | Supply Current, Shutdown (\overline{CS} high) | $V_A = +5.25V$, $f_{SAMPLE} = 0$ kSPS | 90 | | nA |
| | | $V_A = +3.6V$, $f_{SAMPLE} = 0$ kSPS | 33 | | nA |
| P_D | Power Consumption, Normal Mode (Operational, \overline{CS} low) | $V_A = +5.25V$ | 11.4 | 14.2 | mW (max) |
| | | $V_A = +3.6V$ | 3.9 | 4.7 | mW (max) |
| | Power Consumption, Shutdown (\overline{CS} high) | $V_A = +5.25V$ | 0.47 | | μW |
| | | $V_A = +3.6V$ | 0.12 | | μW |
| AC ELECTRICAL CHARACTERISTICS | | | | | |
| f_{SCLK} | Clock Frequency | (Note 8) | | 8 | MHz (min) |
| | | | | 16 | MHz (max) |
| f_S | Sample Rate | (Note 8) | | 500 | kSPS (min) |
| | | | | 1 | MSPS (max) |
| t_{CONV} | Conversion Time | | | 13 | SCLK cycles |
| DC | SCLK Duty Cycle | $f_{CLK} = 16$ MHz | 50 | 30 | % (min) |
| | | | | 70 | % (max) |
| t_{ACQ} | Track/Hold Acquisition Time | Full-Scale Step Input | | 3 | SCLK cycles |
| | Throughput Time | Acquisition Time + Conversion Time | | 16 | SCLK cycles |

ADC104S101 Timing Specifications

The following specifications apply for $V_A = +2.7V$ to $5.25V$, $GND = 0V$, $C_L = 50$ pF, $f_{SCLK} = 8$ MHz to 16 MHz, $f_{SAMPLE} = 500$ kSPS to 1 MSPS, **Boldface limits apply for $T_A = T_{MIN}$ to T_{MAX}** ; all other limits $T_A = 25^\circ C$.

| Symbol | Parameter | Conditions | Typical | Limits (Note 7) | Units | |
|-----------|------------------------------------------------------|----------------|-----------------------|----------------------------|-----------|-------------|
| t_{CSU} | Setup Time SCLK High to \overline{CS} Falling Edge | (Note 10) | $V_A = +3.0V$ | -3.5 | 10 | ns (min) |
| | | | $V_A = +5.0V$ | -0.5 | | |
| t_{CLH} | Hold time SCLK Low to \overline{CS} Falling Edge | (Note 10) | $V_A = +3.0V$ | +4.5 | 10 | ns (min) |
| | | | $V_A = +5.0V$ | +1.5 | | |
| t_{EN} | Delay from \overline{CS} Until DOUT active | | $V_A = +3.0V$ | +4 | 30 | ns (max) |
| | | | $V_A = +5.0V$ | +2 | | |
| t_{ACC} | Data Access Time after SCLK Falling Edge | | $V_A = +3.0V$ | +16.5 | 30 | ns (max) |
| | | | $V_A = +5.0V$ | +15 | | |
| t_{SU} | Data Setup Time Prior to SCLK Rising Edge | | +3 | 10 | ns (min) | |
| t_H | Data Valid SCLK Hold Time | | +3 | 10 | ns (min) | |
| t_{CH} | SCLK High Pulse Width | | $0.5 \times t_{SCLK}$ | 0.3 x t_{SCLK} | ns (min) | |
| t_{CL} | SCLK Low Pulse Width | | $0.5 \times t_{SCLK}$ | 0.3 x t_{SCLK} | ns (min) | |
| t_{DIS} | \overline{CS} Rising Edge to DOUT High-Impedance | Output Falling | $V_A = +3.0V$ | 1.7 | 20 | ns (max) |
| | | | $V_A = +5.0V$ | 1.2 | | |
| | | Output Rising | $V_A = +3.0V$ | 1.0 | | |
| | | | $V_A = +5.0V$ | 1.0 | | |

Note 1: Absolute Maximum Ratings indicate limits beyond which damage to the device may occur. Operating Ratings indicate conditions for which the device is functional, but do not guarantee specific performance limits. For guaranteed specifications and test conditions, see the Electrical Characteristics. The guaranteed specifications apply only for the test conditions listed. Some performance characteristics may degrade when the device is not operated under the listed test conditions.

Note 2: All voltages are measured with respect to $GND = 0V$, unless otherwise specified.

Note 3: When the input voltage at any pin exceeds the power supply (that is, $V_{IN} < GND$ or $V_{IN} > V_A$), the current at that pin should be limited to 10 mA. The 20 mA maximum package input current rating limits the number of pins that can safely exceed the power supplies with an input current of 10 mA to two. The Absolute Maximum Rating specification does not apply to the V_A pin. The current into the V_A pin is limited by the Analog Supply Voltage specification.

Note 4: The absolute maximum junction temperature (T_{Jmax}) for this device is $150^\circ C$. The maximum allowable power dissipation is dictated by T_{Jmax} , the junction-to-ambient thermal resistance (θ_{JA}), and the ambient temperature (T_A), and can be calculated using the formula $P_{DMAX} = (T_{Jmax} - T_A)/\theta_{JA}$. The values for maximum power dissipation listed above will be reached only when the device is operated in a severe fault condition (e.g. when input or output pins are driven beyond the power supply voltages, or the power supply polarity is reversed). Obviously, such conditions should always be avoided.

Note 5: Human body model is 100 pF capacitor discharged through a 1.5 k Ω resistor. Machine model is 220 pF discharged through zero ohms.

Note 6: Reflow temperature profiles are different for lead-free and non-lead-free packages.

Note 7: Tested limits are guaranteed to National's AOQL (Average Outgoing Quality Level).

Note 8: This is the frequency range over which the electrical performance is guaranteed. The device is functional over a wider range which is specified under Operating Ratings.

Note 9: Datasheet min/max specification limits are guaranteed by design, test, or statistical analysis.

Note 10: Clock may be in any state (high or low) when \overline{CS} is asserted, with the restrictions on setup and hold time given by t_{CSU} and t_{CLH} .

Timing Diagrams

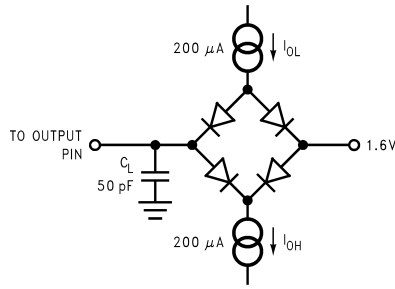

Timing Test Circuit

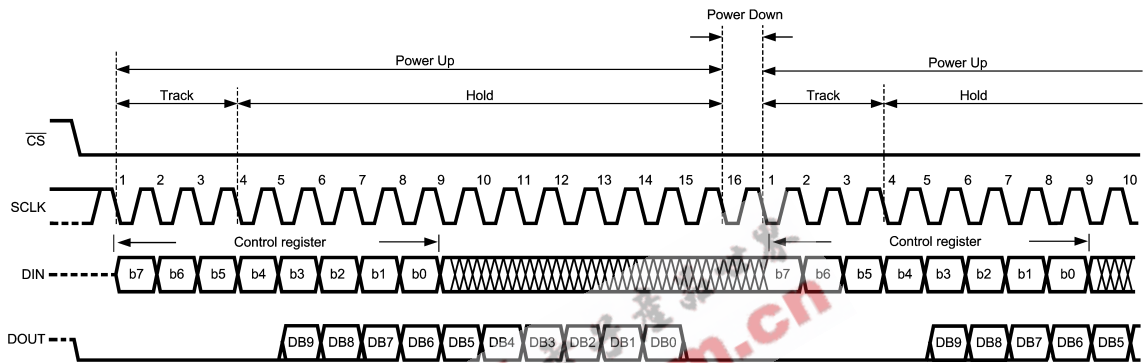

ADC104S101 Operational Timing Diagram

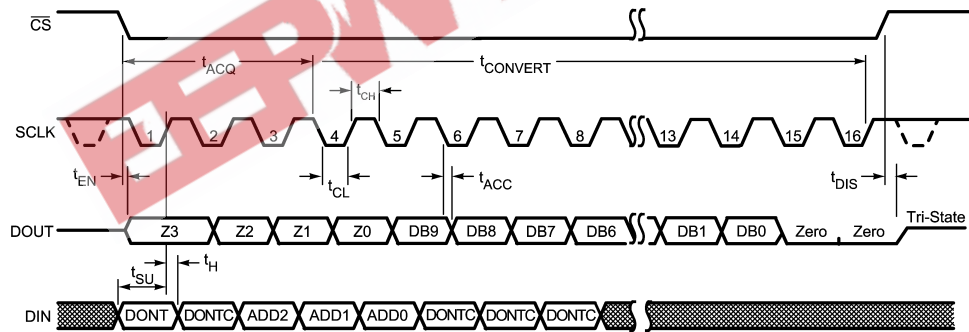

ADC104S101 Serial Timing Diagram

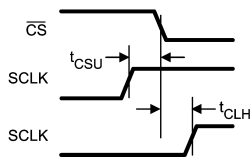

SCLK and CS Timing Parameters

Specification Definitions

ACQUISITION TIME is the time required to acquire the input voltage. That is, it is time required for the hold capacitor to charge up to the input voltage.

APERTURE DELAY is the time between the fourth falling SCLK edge of a conversion and the time when the input signal is acquired or held for conversion.

CONVERSION TIME is the time required, after the input voltage is acquired, for the ADC to convert the input voltage to a digital word.

CROSSTALK is the coupling of energy from one channel into the other channel, or the amount of signal energy from one analog input that appears at the measured analog input.

DIFFERENTIAL NON-LINEARITY (DNL) is the measure of the maximum deviation from the ideal step size of 1 LSB.

DUTY CYCLE is the ratio of the time that a repetitive digital waveform is high to the total time of one period. The specification here refers to the SCLK.

EFFECTIVE NUMBER OF BITS (ENOB, or EFFECTIVE BITS) is another method of specifying Signal-to-Noise and Distortion or SINAD. ENOB is defined as $(\text{SINAD} - 1.76) / 6.02$ and says that the converter is equivalent to a perfect ADC of this (ENOB) number of bits.

FULL POWER BANDWIDTH is a measure of the frequency at which the reconstructed output fundamental drops 3 dB below its low frequency value for a full scale input.

GAIN ERROR is the deviation of the last code transition (111...110) to (111...111) from the ideal ($V_{\text{REF}} - 1.5 \text{ LSB}$), after adjusting for offset error.

INTEGRAL NON-LINEARITY (INL) is a measure of the deviation of each individual code from a line drawn from negative full scale ($1/2 \text{ LSB}$ below the first code transition) through positive full scale ($1/2 \text{ LSB}$ above the last code transition). The deviation of any given code from this straight line is measured from the center of that code value.

INTERMODULATION DISTORTION (IMD) is the creation of additional spectral components as a result of two sinusoidal frequencies being applied to the ADC input at the same time. It is defined as the ratio of the power in the second and third order intermodulation products to the sum of the power in both of the original frequencies. IMD is usually expressed in dB.

MISSING CODES are those output codes that will never appear at the ADC outputs. The ADC104S101 is guaranteed not to have any missing codes.

OFFSET ERROR is the deviation of the first code transition (000...000) to (000...001) from the ideal (i.e. GND + 0.5 LSB).

SIGNAL TO NOISE RATIO (SNR) is the ratio, expressed in dB, of the rms value of the input signal to the rms value of the sum of all other spectral components below one-half the sampling frequency, not including harmonics or d.c.

SIGNAL TO NOISE PLUS DISTORTION (S/N+D or SINAD) Is the ratio, expressed in dB, of the rms value of the input signal to the rms value of all of the other spectral components below half the clock frequency, including harmonics but excluding d.c.

SPURIOUS FREE DYNAMIC RANGE (SFDR) is the difference, expressed in dB, between the rms values of the input signal and the peak spurious signal where a spurious signal is any signal present in the output spectrum that is not present at the input, excluding d.c.

TOTAL HARMONIC DISTORTION (THD) is the ratio, expressed in dB or dBc, of the rms total of the first five harmonic components at the output to the rms level of the input signal frequency as seen at the output. THD is calculated as

$$\text{THD} = 20 \cdot \log_{10} \sqrt{\frac{A_{f2}^2 + \dots + A_{f6}^2}{A_{f1}^2}}$$

where A_{f1} is the RMS power of the input frequency at the output and A_{f2} through A_{f6} are the RMS power in the first 5 harmonic frequencies.

THROUGHPUT TIME is the minimum time required between the start of two successive conversion. It is the acquisition time plus the conversion time. In the case of the ADC104S101, this is 16 SCLK periods.

Typical Performance Characteristics $T_A = +25^\circ\text{C}$, $f_{\text{SAMPLE}} = 500 \text{ kSPS to } 1 \text{ MSPS}$,
 $f_{\text{SCLK}} = 8 \text{ MHz to } 16 \text{ MHz}$, $f_{\text{IN}} = 40.3 \text{ kHz}$ unless otherwise stated.

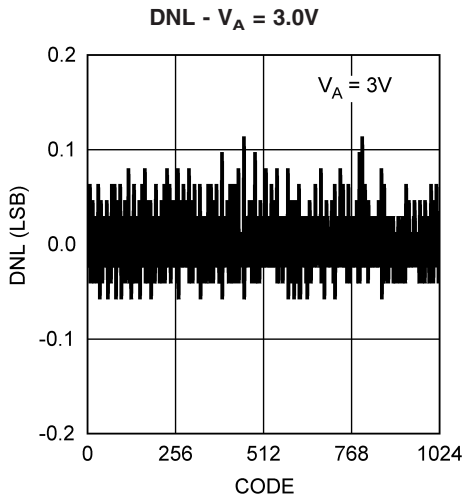

20125020

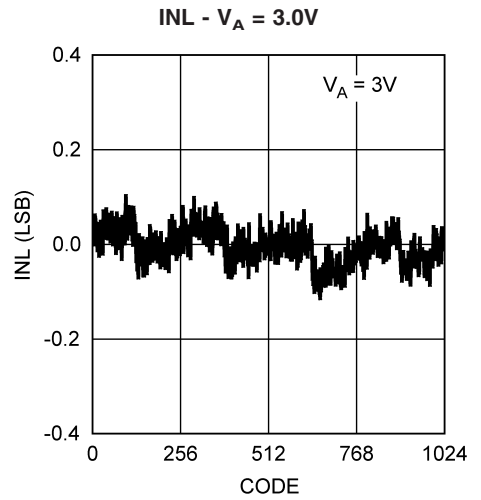

20125021

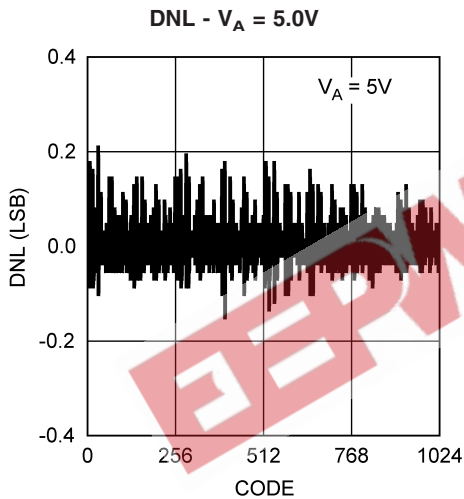

20125062

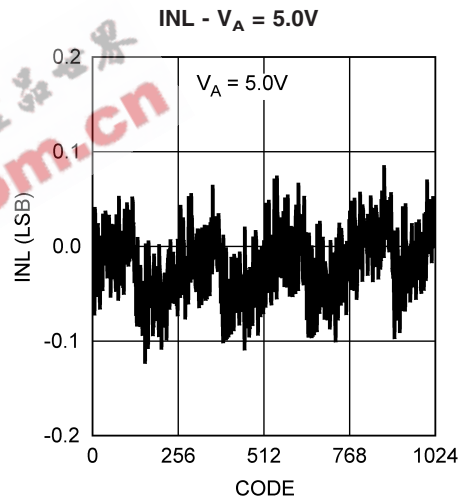

20125063

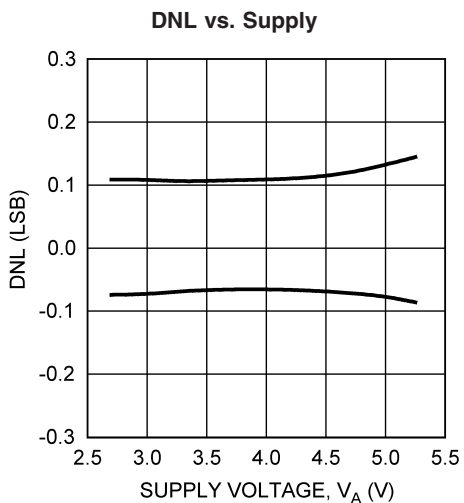

20125022

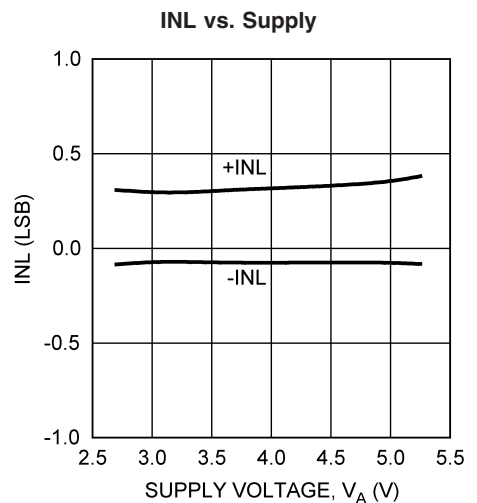

20125023

Typical Performance Characteristics $T_A = +25^\circ\text{C}$, $f_{\text{SAMPLE}} = 500 \text{ kSPS to } 1 \text{ MSPS}$,
 $f_{\text{SCLK}} = 8 \text{ MHz to } 16 \text{ MHz}$, $f_{\text{IN}} = 40.3 \text{ kHz}$ unless otherwise stated. (Continued)

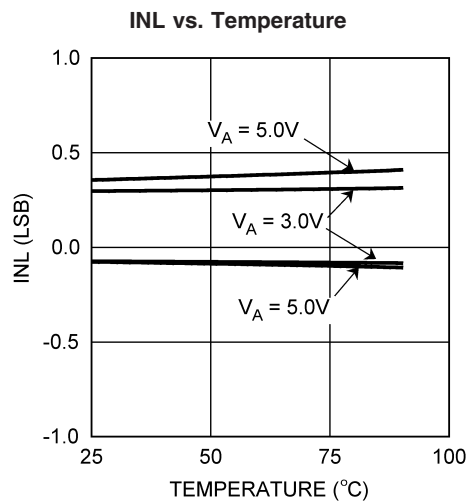
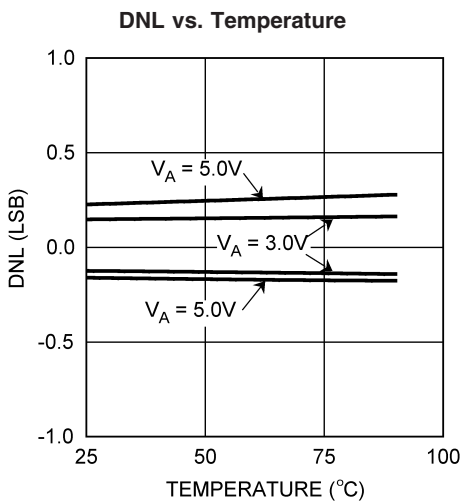
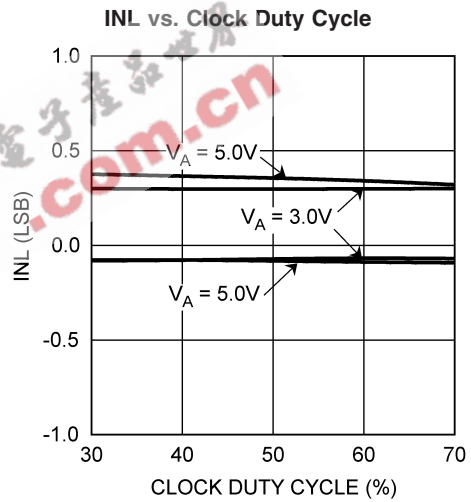
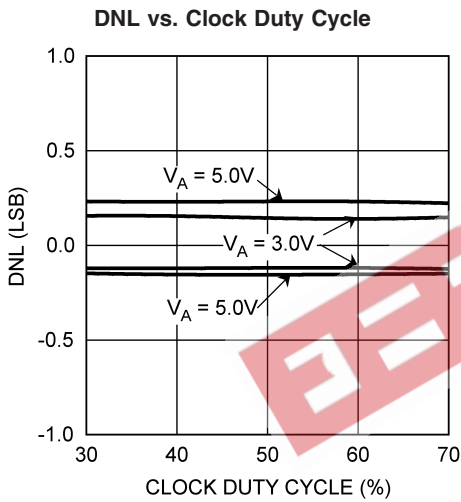
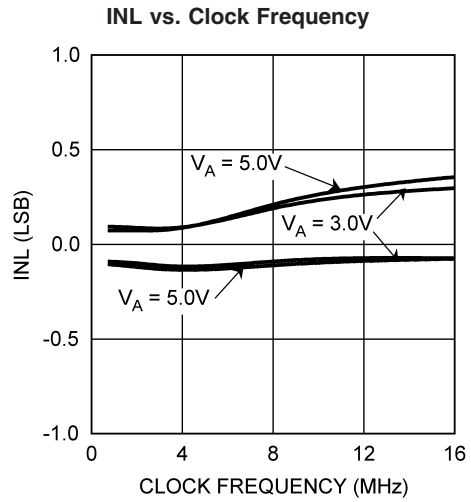
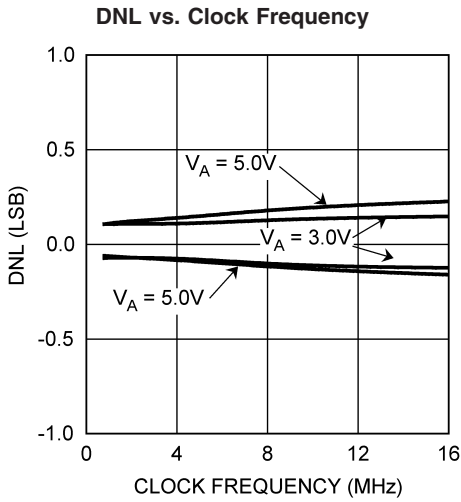

Typical Performance Characteristics $T_A = +25^\circ\text{C}$, $f_{\text{SAMPLE}} = 500 \text{ kSPS to } 1 \text{ MSPS}$,
 $f_{\text{SCLK}} = 8 \text{ MHz to } 16 \text{ MHz}$, $f_{\text{IN}} = 40.3 \text{ kHz}$ unless otherwise stated. (Continued)

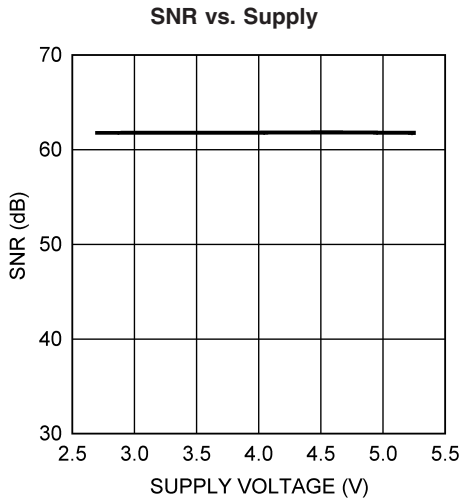

20125030

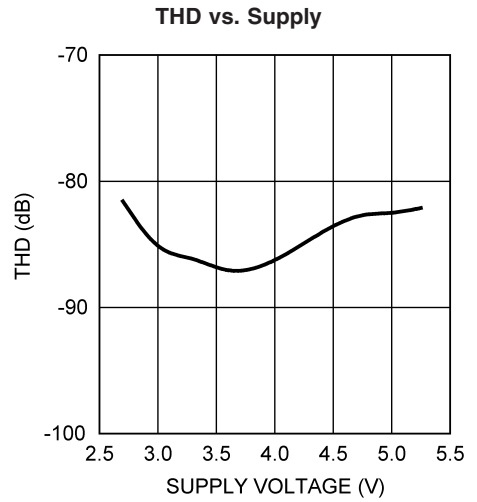

20125035

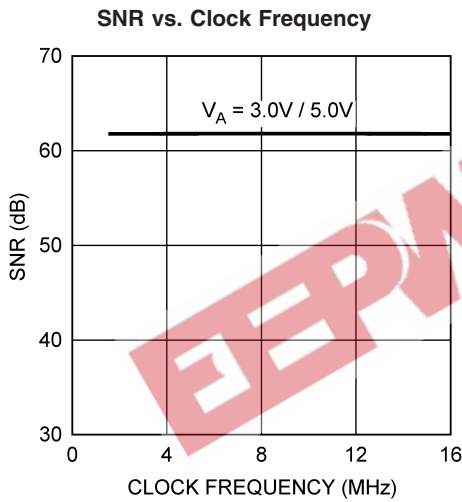

20125031

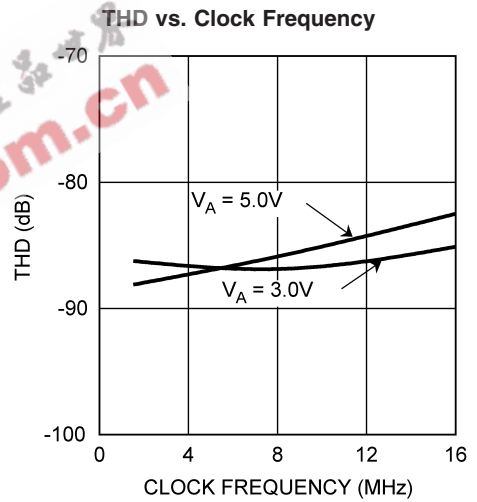

20125036

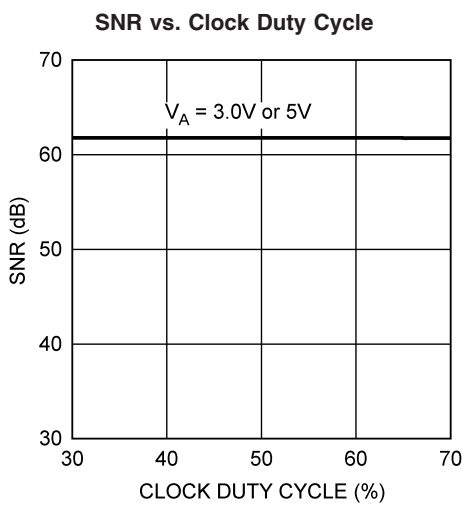

20125032

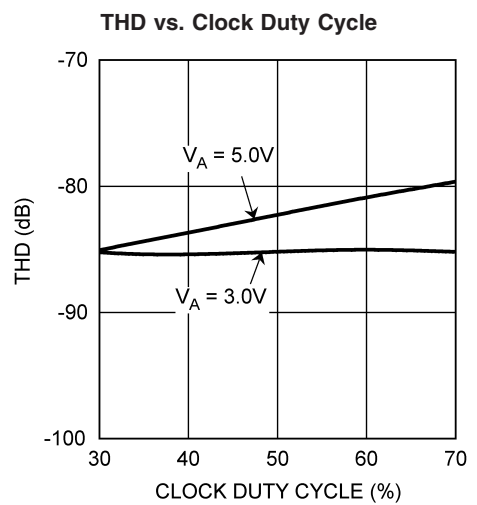

20125037

Typical Performance Characteristics $T_A = +25^\circ\text{C}$, $f_{\text{SAMPLE}} = 500 \text{ kSPS to } 1 \text{ MSPS}$,
 $f_{\text{SCLK}} = 8 \text{ MHz to } 16 \text{ MHz}$, $f_{\text{IN}} = 40.3 \text{ kHz}$ unless otherwise stated. (Continued)

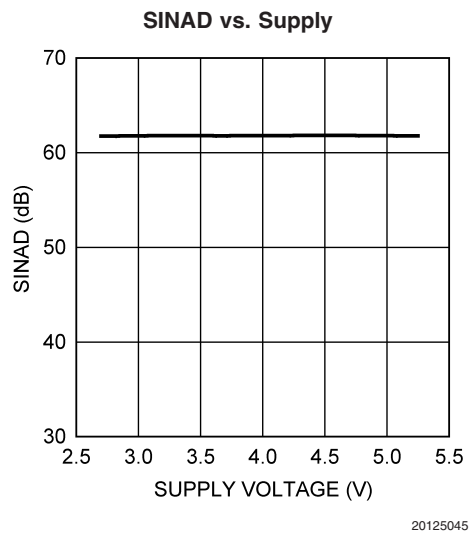
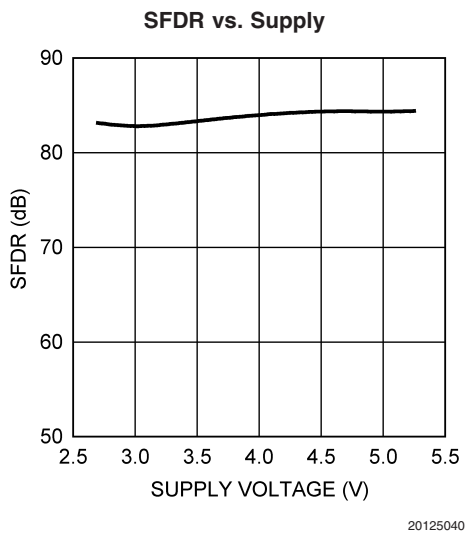
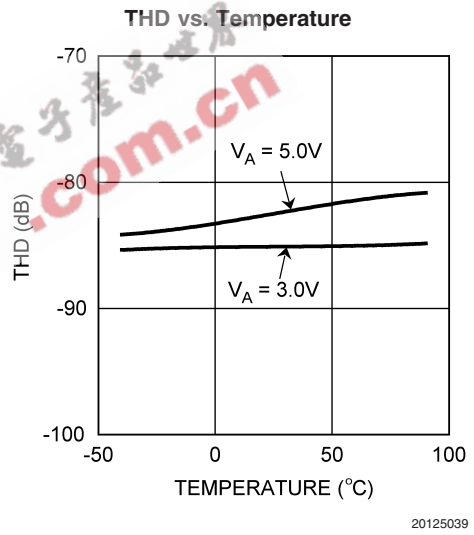
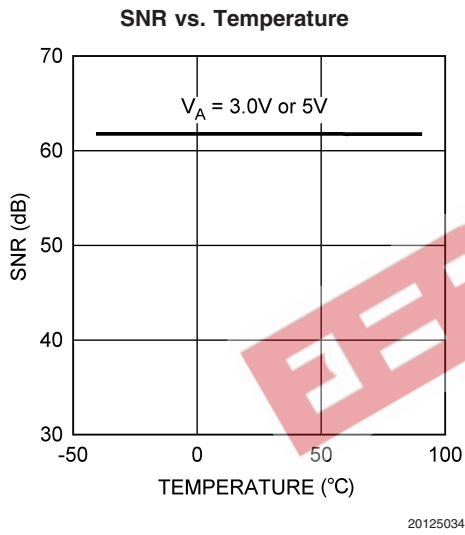
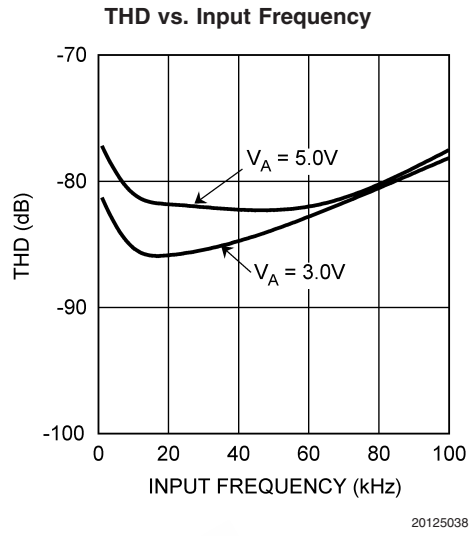
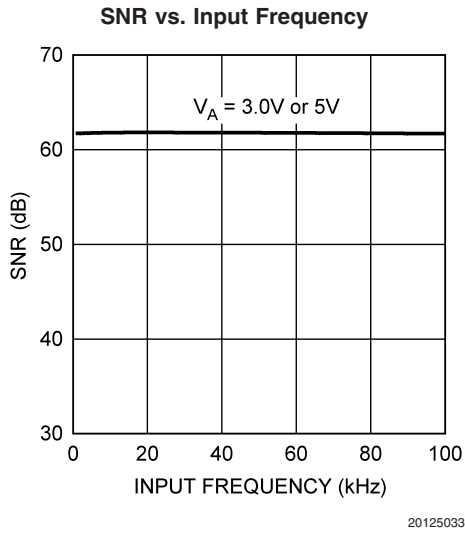

Typical Performance Characteristics $T_A = +25^\circ\text{C}$, $f_{\text{SAMPLE}} = 500 \text{ kSPS to } 1 \text{ MSPS}$,
 $f_{\text{SCLK}} = 8 \text{ MHz to } 16 \text{ MHz}$, $f_{\text{IN}} = 40.3 \text{ kHz}$ unless otherwise stated. (Continued)

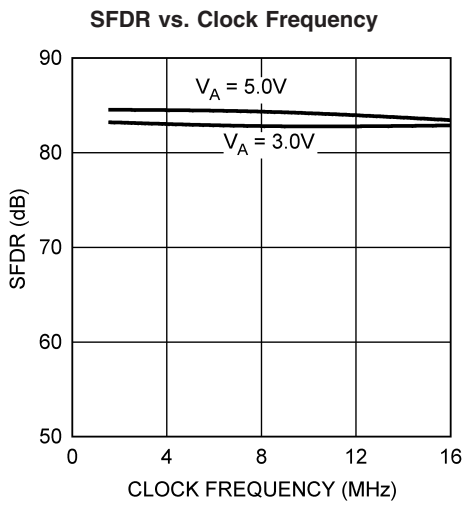

20125041

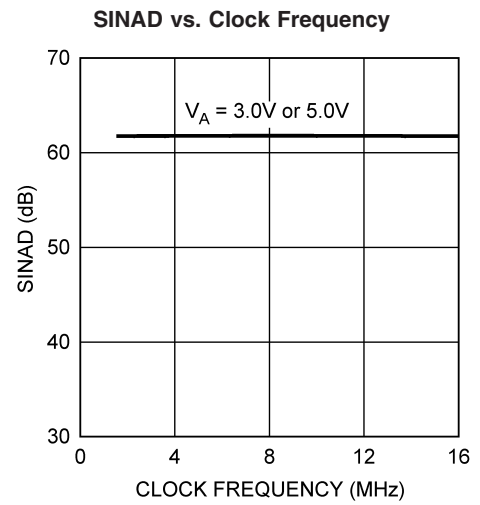

20125046

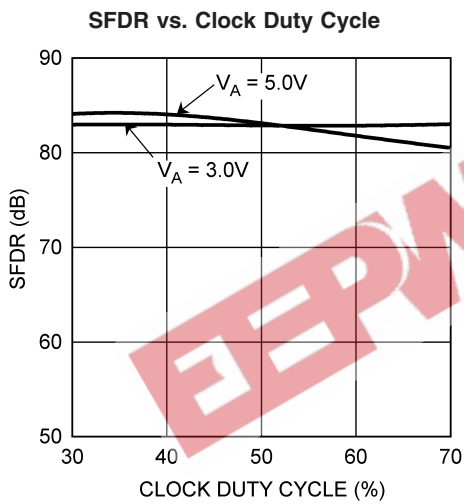

20125042

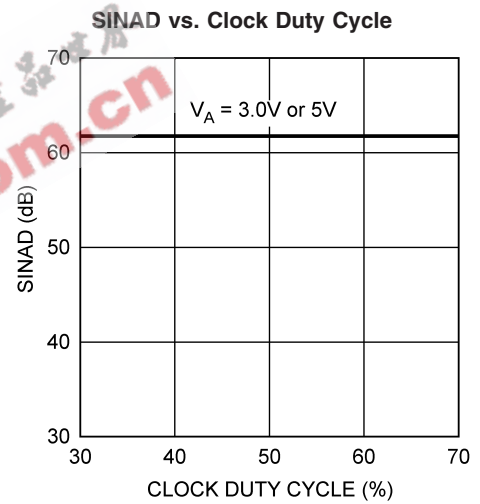

20125047

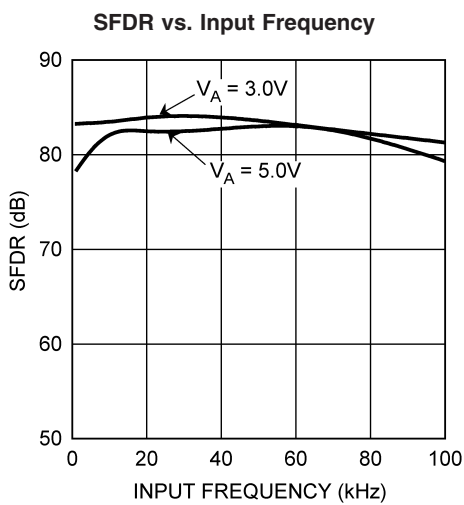

20125043

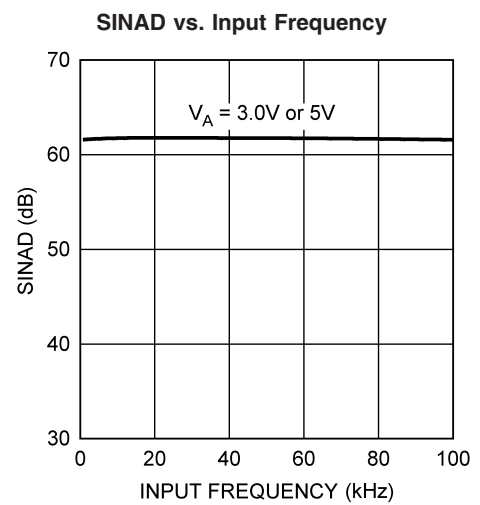

20125048

Typical Performance Characteristics $T_A = +25^\circ\text{C}$, $f_{\text{SAMPLE}} = 500 \text{ kSPS to } 1 \text{ MSPS}$,
 $f_{\text{SCLK}} = 8 \text{ MHz to } 16 \text{ MHz}$, $f_{\text{IN}} = 40.3 \text{ kHz}$ unless otherwise stated. (Continued)

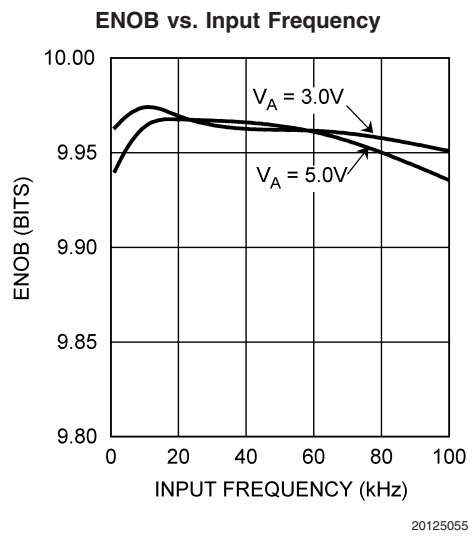
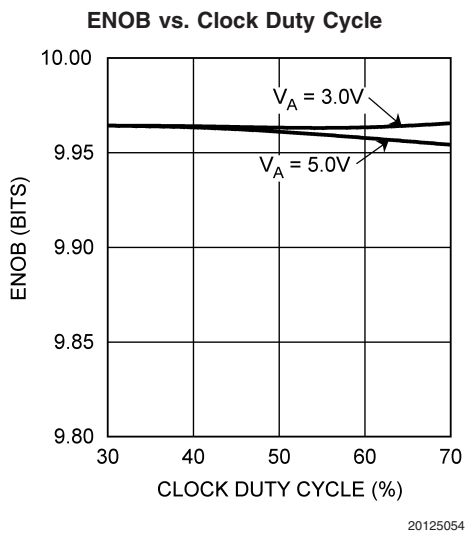
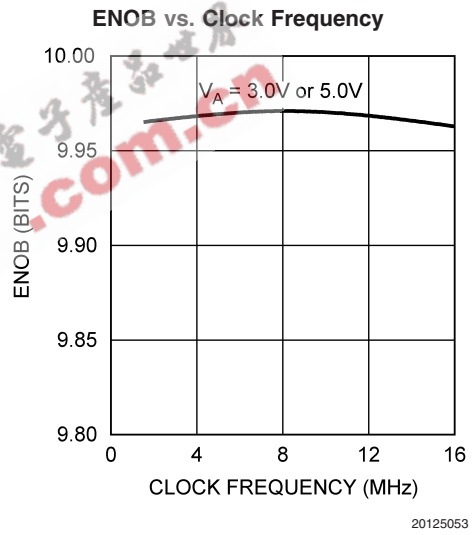
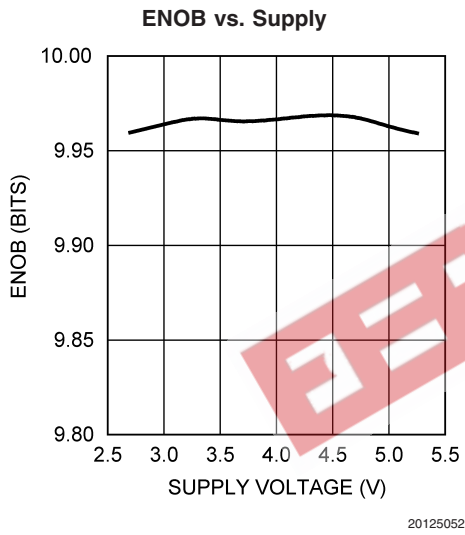
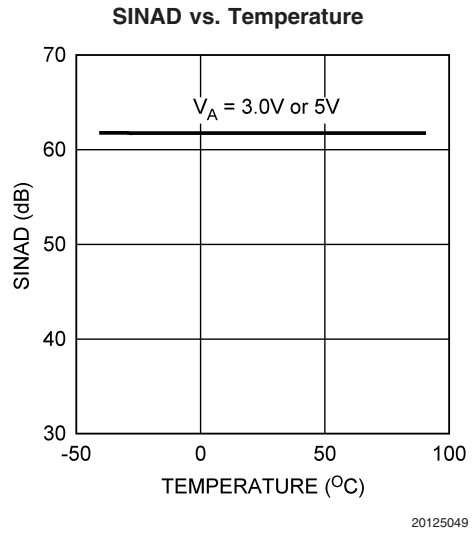
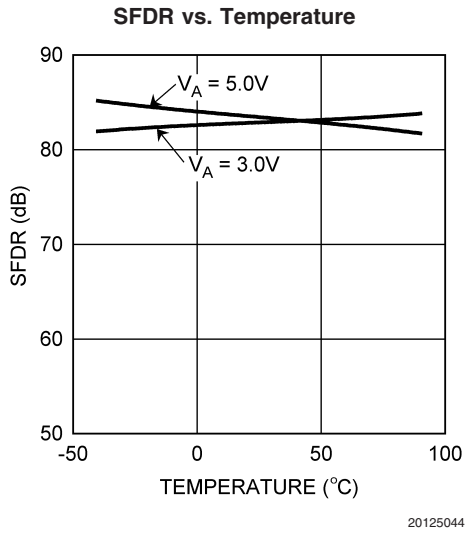

Typical Performance Characteristics $T_A = +25^\circ\text{C}$, $f_{\text{SAMPLE}} = 500 \text{ kSPS to } 1 \text{ MSPS}$,
 $f_{\text{SCLK}} = 8 \text{ MHz to } 16 \text{ MHz}$, $f_{\text{IN}} = 40.3 \text{ kHz}$ unless otherwise stated. (Continued)

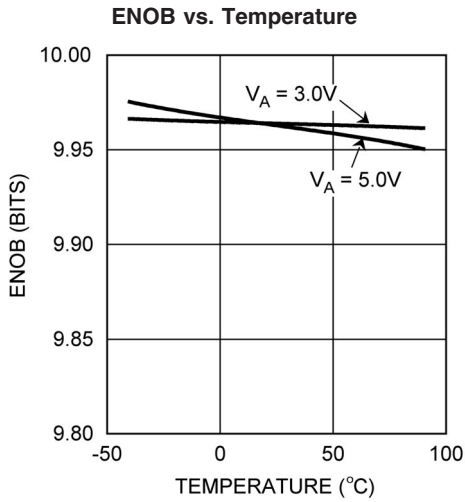

20125056

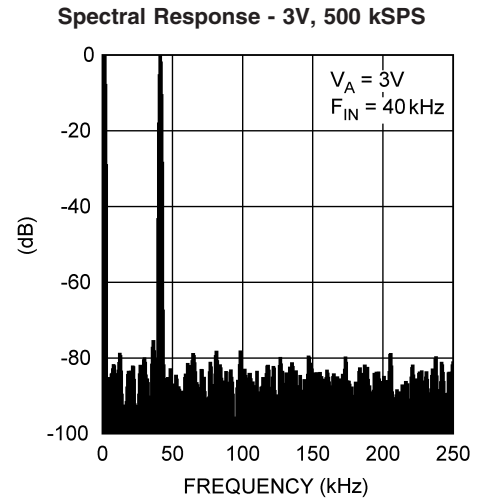

20125064

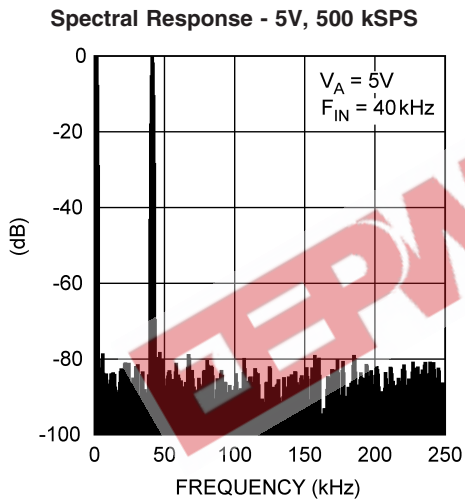

20125065

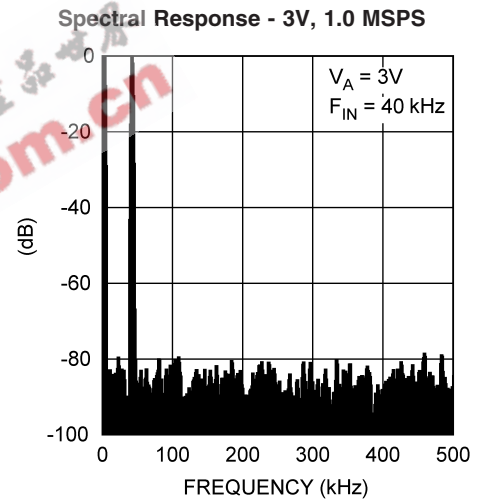

20125059

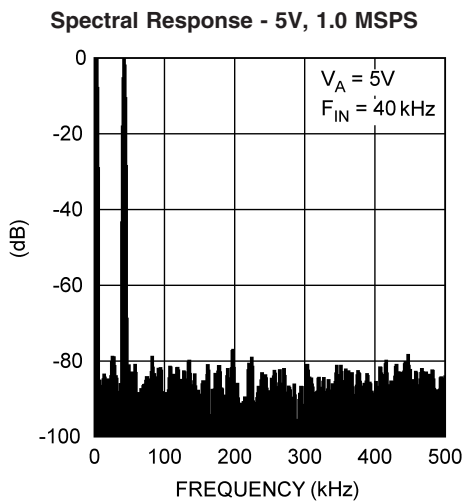

20125060

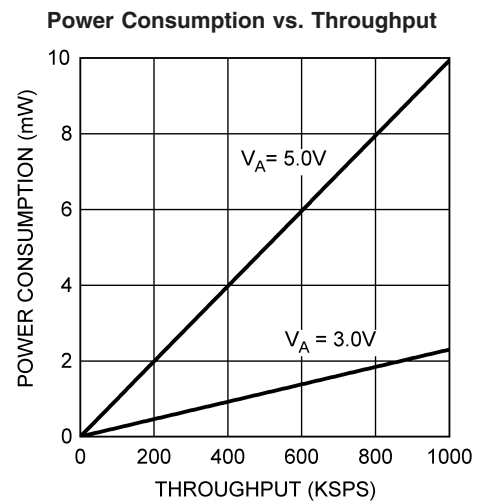

20125061

Applications Information

1.0 ADC104S101 OPERATION

The ADC104S101 is a successive-approximation analog-to-digital converter designed around a charge-redistribution digital-to-analog converter. Simplified schematics of the ADC104S101 in both track and hold modes are shown in *Figures 1, 2*, respectively. In *Figure 1*, the ADC104S101 is in track mode: switch SW1 connects the sampling capacitor to one of four analog input channels through the multiplexer, and SW2 balances the comparator inputs. The ADC104S101 is in this state for the first three SCLK cycles after \overline{CS} is brought low.

Figure 2 shows the ADC104S101 in hold mode: switch SW1 connects the sampling capacitor to ground, maintaining the

sampled voltage, and switch SW2 unbalances the comparator. The control logic then instructs the charge-redistribution DAC to add fixed amounts of charge to the sampling capacitor until the comparator is balanced. When the comparator is balanced, the digital word supplied to the DAC is the digital representation of the analog input voltage. The ADC104S101 is in this state for the fourth through sixteenth SCLK cycles after \overline{CS} is brought low.

The time when \overline{CS} is low is considered a serial frame. Each of these frames should contain an integer multiple of 16 SCLK cycles, during which time a conversion is performed and clocked out at the DOUT pin and data is clocked into the DIN pin to indicate the multiplexer address for the next conversion.

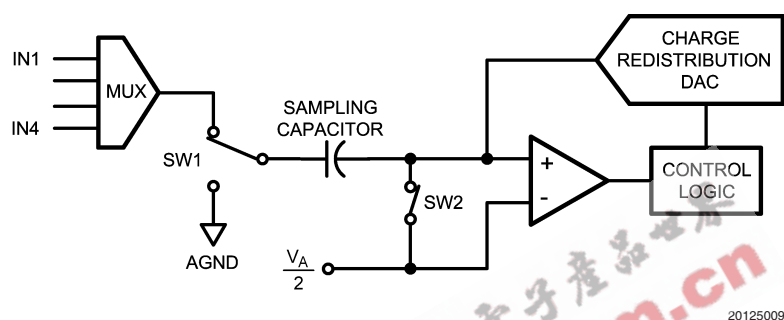

FIGURE 1. ADC104S101 in Track Mode

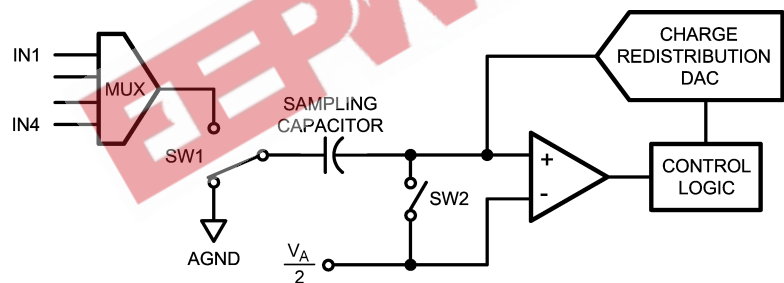

FIGURE 2. ADC104S101 in Hold Mode

2.0 USING THE ADC104S101

An ADC104S101 timing diagram and a serial interface timing diagram for the ADC104S101 are shown in the Timing Diagrams section. \overline{CS} is chip select, which initiates conversions and frames the serial data transfers. SCLK (serial clock) controls both the conversion process and the timing of serial data. DOUT is the serial data output pin, where a conversion result is sent as a serial data stream, MSB first. Data to be written to the ADC104S101's Control Register is placed on DIN, the serial data input pin. New data is written to DIN with each conversion.

A serial frame is initiated on the falling edge of \overline{CS} and ends on the rising edge of \overline{CS} . Each frame must contain an integer multiple of 16 rising SCLK edges. The ADC output data (DOUT) is in a high impedance state when \overline{CS} is high and is active when \overline{CS} is low. Thus, \overline{CS} acts as an output enable. Additionally, the device goes into a power down state when \overline{CS} is high, and also between continuous conversion cycles.

During the first 3 cycles of SCLK, the ADC is in the track mode, acquiring the input voltage. For the next 13 SCLK cycles the conversion is accomplished and the data is clocked out, MSB first, starting on the 5th clock. If there is more than one conversion in a frame, the ADC will re-enter the track mode on the falling edge of SCLK after the $N \cdot 16$ th rising edge of SCLK, and re-enter the hold/convert mode on the $N \cdot 16 + 4$ th falling edge of SCLK, where "N" is an integer. When \overline{CS} is brought high, SCLK is internally gated off. If SCLK is stopped in the low state while \overline{CS} is high, the subsequent fall of \overline{CS} will generate a falling edge of the internal version of SCLK, putting the ADC into the track mode. This is seen by the ADC as the first falling edge of SCLK. If SCLK is stopped with SCLK high, the ADC enters the track mode on the first falling edge of SCLK after the falling edge of \overline{CS} .

During each conversion, data is clocked into the DIN pin on the first 8 rising edges of SCLK after the fall of \overline{CS} . For each

Applications Information (Continued)

conversion, it is necessary to clock in the data indicating the input that is selected for the conversion after the current one. See *Tables 1, 2* and *Table 3*.

If \overline{CS} and SCLK go low simultaneously, it is the following rising edge of SCLK that is considered the first rising edge for clocking data into DIN.

There are no power-up delays or dummy conversions required with the ADC104S101. The ADC is able to sample and convert an input to full conversion immediately following power up. The first conversion result after power-up will be that of IN1.

TABLE 1. Control Register Bits

| | | | | | | | |
|-------------|-------|-------|-------|-------|-------|-------|-------|
| Bit 7 (MSB) | Bit 6 | Bit 5 | Bit 4 | Bit 3 | Bit 2 | Bit 1 | Bit 0 |
| DONTC | DONTC | ADD2 | ADD1 | ADD0 | DONTC | DONTC | DONTC |

TABLE 2. Control Register Bit Descriptions

| Bit #: | Symbol: | Description |
|--------------|---------|--------------------------------------------------------------------------------------------------------------------------------------------------------------------------------|
| 7 - 6, 2 - 0 | DONTC | Don't care. The value of these bits do not affect device operation. |
| 5 | ADD2 | These three bits determine which input channel will be sampled and converted in the next track/hold cycle. The mapping between codes and channels is shown in <i>Table 3</i> . |
| 4 | ADD1 | |
| 3 | ADD0 | |

TABLE 3. Input Channel Selection

| ADD2 | ADD1 | ADD0 | Input Channel |
|------|------|------|---------------|
| x | 0 | 0 | IN1 (Default) |
| x | 0 | 1 | IN2 |
| x | 1 | 0 | IN3 |
| x | 1 | 1 | IN4 |

Applications Information (Continued)

3.0 ADC104S101 TRANSFER FUNCTION

The output format of the ADC104S101 is straight binary. Code transitions occur midway between successive integer LSB values. The LSB width for the ADC104S101 is $V_A/1024$. The ideal transfer characteristic is shown in *Figure 3*. The transition from an output code of 00 0000 0000 to a code of 00 0000 0001 is at 1/2 LSB, or a voltage of $V_A/2048$. Other code transitions occur at steps of one LSB.

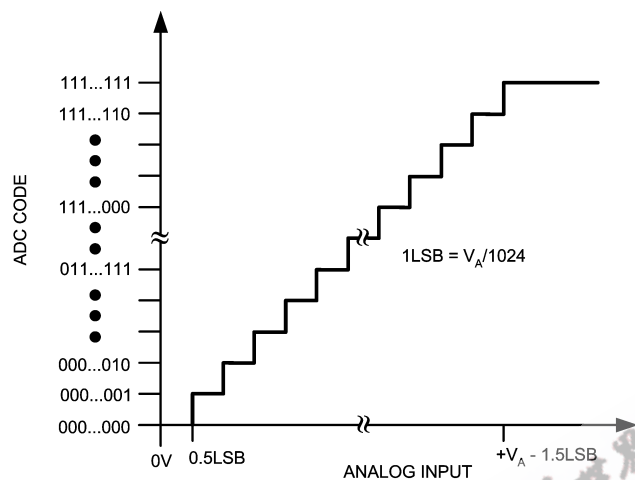
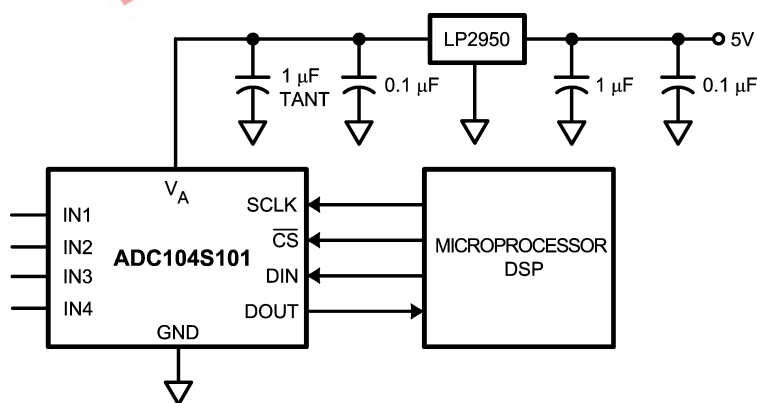

FIGURE 3. Ideal Transfer Characteristic

4.0 TYPICAL APPLICATION CIRCUIT

A typical application of the ADC104S101 is shown in *Figure 4*. Power is provided in this example by the National Semiconductor LP2950 low-dropout voltage regulator, available in a variety of fixed and adjustable output voltages. The power supply pin is bypassed with a capacitor network located close to the ADC104S101. Because the reference for the ADC104S101 is the supply voltage, any noise on the supply

will degrade device noise performance. To keep noise off the supply, use a dedicated linear regulator for this device, or provide sufficient decoupling from other circuitry to keep noise off the ADC104S101 supply pin. Because of the ADC104S101's low power requirements, it is also possible to use a precision reference as a power supply to maximize performance. The four-wire interface is also shown connected to a microprocessor or DSP.



20125013

FIGURE 4. Typical Application Circuit

Applications Information (Continued)

5.0 ANALOG INPUTS

An equivalent circuit for one of the ADC104S101's input channels is shown in *Figure 5*. Diodes D1 and D2 provide ESD protection for the analog inputs. At no time should any input go beyond ($V_A + 300$ mV) or ($GND - 300$ mV), as these ESD diodes will begin conducting, which could result in erratic operation.

The capacitor C1 in *Figure 5* has a typical value of 3 pF, and is mainly the package pin capacitance. Resistor R1 is the on resistance of the multiplexer and track / hold switch, and is typically 500 ohms. Capacitor C2 is the ADC104S101 sampling capacitor, and is typically 30 pF. The ADC104S101 will deliver best performance when driven by a low-impedance source to eliminate distortion caused by the charging of the sampling capacitance. This is especially important when using the ADC104S101 to sample AC signals. Also important when sampling dynamic signals is a band-pass or low-pass filter to reduce harmonics and noise, improving dynamic performance.

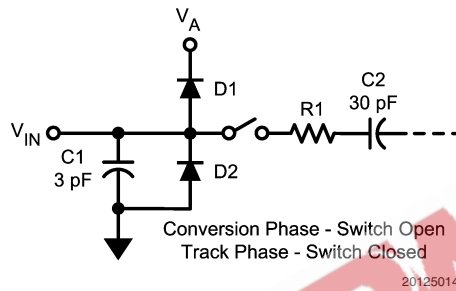

FIGURE 5. Equivalent Input Circuit

6.0 DIGITAL INPUTS AND OUTPUTS

The ADC104S101's digital output \overline{DOUT} is limited by, and cannot exceed, the supply voltage, V_A . The digital input pins are not prone to latch-up and, although not recommended, \overline{SCLK} , \overline{CS} and \overline{DIN} may be asserted before V_A without any latch-up risk.

7.0 POWER SUPPLY CONSIDERATIONS

The ADC104S101 is fully powered-up whenever \overline{CS} is low, and fully powered-down whenever \overline{CS} is high, with one exception: the ADC104S101 automatically enters power-down mode between the 16th falling edge of a conversion and the 1st falling edge of the subsequent conversion (see Timing Diagrams).

The ADC104S101 can perform multiple conversions back to back; each conversion requires 16 \overline{SCLK} cycles. The ADC104S101 will perform conversions continuously as long as \overline{CS} is held low.

The user may trade off throughput for power consumption by simply performing fewer conversions per unit time. The Power Consumption vs. Sample Rate curve in the Typical Performance Curves section shows the typical power consumption of the ADC104S101 versus throughput. To calculate the power consumption, simply multiply the fraction of time spent in the normal mode by the normal mode power consumption, and add the fraction of time spent in shutdown mode multiplied by the shutdown mode power dissipation.

7.1 Power Management

When the ADC104S101 is operated continuously in normal mode, the maximum throughput is $f_{SCLK}/16$. Throughput may be traded for power consumption by running f_{SCLK} at its maximum 16 MHz and performing fewer conversions per unit time, putting the ADC104S101 into shutdown mode between conversions. A plot of typical power consumption versus throughput is shown in the Typical Performance Curves section. To calculate the power consumption for a given throughput, multiply the fraction of time spent in the normal mode by the normal mode power consumption and add the fraction of time spent in shutdown mode multiplied by the shutdown mode power consumption. Generally, the user will put the part into normal mode and then put the part back into shutdown mode. Note that the curve of power consumption vs. throughput is nearly linear. This is because the power consumption in the shutdown mode is so small that it can be ignored for all practical purposes.

7.2 Power Supply Noise Considerations

The charging of any output load capacitance requires current from the power supply, V_A . The current pulses required from the supply to charge the output capacitance will cause voltage variations on the supply. If these variations are large enough, they could degrade SNR and SINAD performance of the ADC. Furthermore, discharging the output capacitance when the digital output goes from a logic high to a logic low will dump current into the die substrate, which is resistive. Load discharge currents will cause "ground bounce" noise in the substrate that will degrade noise performance if that current is large enough. The larger is the output capacitance, the more current flows through the die substrate and the greater is the noise coupled into the analog channel, degrading noise performance.

To keep noise out of the power supply, keep the output load capacitance as small as practical. If the load capacitance is greater than 50 pF, use a 100 Ω series resistor at the ADC output, located as close to the ADC output pin as practical. This will limit the charge and discharge current of the output capacitance and improve noise performance.

Physical Dimensions inches (millimeters) unless otherwise noted

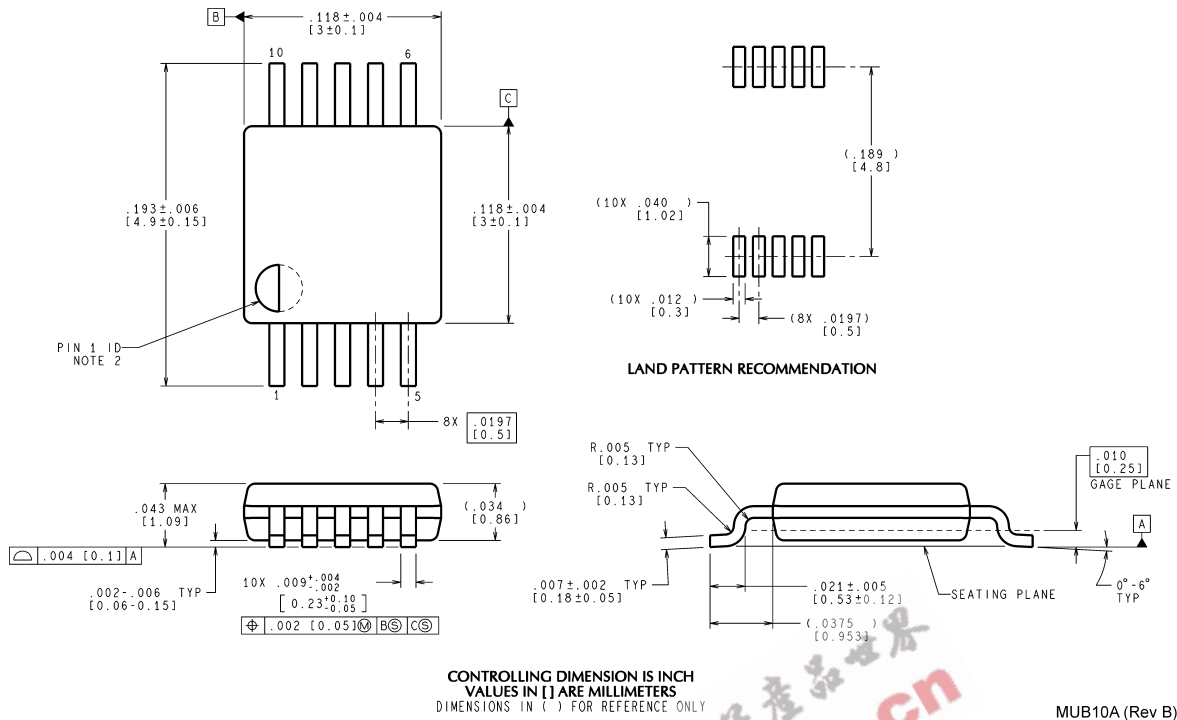

10-Lead MSOP
Order Number ADC104S101C1MM, ADC104S101C1MMX
NS Package Number POMUB10A

National does not assume any responsibility for use of any circuitry described, no circuit patent licenses are implied and National reserves the right at any time without notice to change said circuitry and specifications.
 For the most current product information visit us at www.national.com.

LIFE SUPPORT POLICY

NATIONAL'S PRODUCTS ARE NOT AUTHORIZED FOR USE AS CRITICAL COMPONENTS IN LIFE SUPPORT DEVICES OR SYSTEMS WITHOUT THE EXPRESS WRITTEN APPROVAL OF THE PRESIDENT AND GENERAL COUNSEL OF NATIONAL SEMICONDUCTOR CORPORATION. As used herein:

1. Life support devices or systems are devices or systems which, (a) are intended for surgical implant into the body, or (b) support or sustain life, and whose failure to perform when properly used in accordance with instructions for use provided in the labeling, can be reasonably expected to result in a significant injury to the user.
2. A critical component is any component of a life support device or system whose failure to perform can be reasonably expected to cause the failure of the life support device or system, or to affect its safety or effectiveness.

BANNED SUBSTANCE COMPLIANCE

National Semiconductor manufactures products and uses packing materials that meet the provisions of the Customer Products Stewardship Specification (CSP-9-111C2) and the Banned Substances and Materials of Interest Specification (CSP-9-111S2) and contain no "Banned Substances" as defined in CSP-9-111S2.

National Semiconductor
Americas Customer Support Center
 Email: new.feedback@nsc.com
 Tel: 1-800-272-9959

National Semiconductor
Europe Customer Support Center
 Fax: +49 (0) 180-530 85 86
 Email: europe.support@nsc.com
 Deutsch Tel: +49 (0) 69 9508 6208
 English Tel: +44 (0) 870 24 0 2171
 Français Tel: +33 (0) 1 41 91 8790

National Semiconductor
Asia Pacific Customer Support Center
 Email: ap.support@nsc.com

National Semiconductor
Japan Customer Support Center
 Fax: 81-3-5639-7507
 Email: jpn.feedback@nsc.com
 Tel: 81-3-5639-7560