

1.2 W High Efficiency Power Amplifier

800 - 960 MHz

AM52-0001

V1.00

Features

- SOIC-8 Thermally Efficient Plastic Package
- +30.8 dBm Typical Power Out
- Greater than 50% Typical Power Added Efficiency
- 21 dB typical Power Gain
- Flexible External Output Matching

Description

M/A-COM's AM52-0001 is a GaAs power amplifier in a thermally efficient low cost SOIC-8 plastic package. The AM52-0001 is designed for high efficiency 1.2 W output power and 21 dB of associated gain in the 800-960 MHz frequency band. The AM52-0001 is unconditionally stable in both small and large signal operation. It features flexible biasing for improved dynamic range and off-chip matching for improved efficiency and flexibility.

The AM52-0001 is specifically designed for high efficiency final output power amplification in FM, GFSK and FSK type systems, such as AMPS, ETACS, NTACS, CT1, CDPD and ISM.

M/A-COM's AM52-0001 is fabricated using a mature 0.5 micron gate length GaAs MESFET power process. The process features full passivation for increased performance and reliability. The AM52-0001 can be used with standard automated SMT assembly equipment (See M/A-COM application note M558).

SOIC-8P

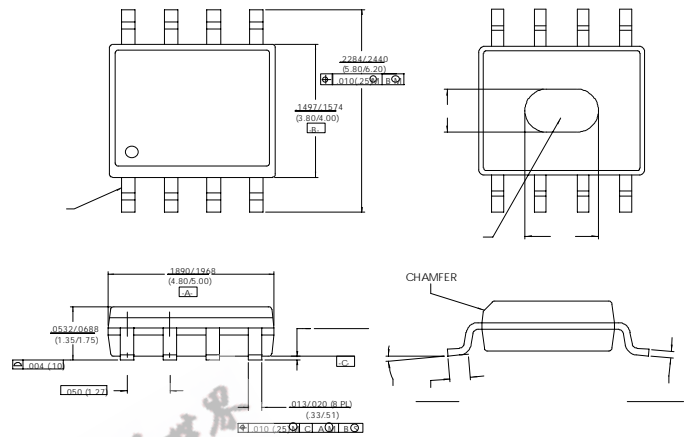

Ordering Information

Part Number	Package
AM52-0001	SOIC-8 Lead Plastic
AM52-0001TR	Forward Tape and Reel *
AM52-0001SMB	Designer's Kit

* If specific reel size is required, consult factory for part number assignment.

Electrical Specifications: $V_{D1} = V_{D2} = 4.8V \pm 5\%$, $T_A = +25^\circ C$, Freq. = 824-849 MHz, $V_{GG} = V_{G2} = V_{G1}$ adjusted for 150 mA quiescent drain Current.

Parameter	Test Conditions	Units	Min.	Typ.	Max.	
Linear Gain	$P_{in} \leq -20$ dBm	dB		29		
Output Power	$P_{in} = 10$ dBm	dBm		30.8		
Power Gain		dB		21		
Power Added Efficiency		%		55		
Second Harmonic		dBc		-30		
Third Harmonic		dBc		-50		
Noise Power ¹		dBm		-92		
Stability ²		VSWR				10:1
Load Mismatch ³		VSWR				10:1
Gate Current			mA			5
Adjustable Power Control (APC)	$V_{D1} = 0 \rightarrow 4.8V$ $V_{D2} = 4.8V$	dB		27		

1. Noise power (30 KHz RBW), 45 MHz above T_x Freq range, measured under rated output power conditions.

2. Parasitic Oscillation defined as any spurious output less than 60 dBc with respect to desired signal level. Measured with nominal P_{in} and an output VSWR of 10:1 any phase, $V_{DD} = 4.8V$.

3. No permanent degradation with nominal P_{in} and an output VSWR of 10:1 at any phase (360° rotation in 10 sec.) with V_{DD} up to 6V. .

Specifications Subject to Change Without Notice.

M/A-COM Inc.

North America: Tel. (800) 366-2266 ♦ Asia/Pacific: Tel. +81 3 3226-8761 ♦ Europe: Tel. +44 (1344) 869-595
 Fax (800) 618-8883 Fax +81 3 3226-8769 Fax +44 (1344) 300 020

Absolute Maximum Ratings ¹

Parameter	Absolute Maximum
Input Power ²	+23 dBm
Operating Voltage ²	V _{DD} = + 10 Volts V _{GG} = - 6 Volts
Junction Temperature ³	+150 °C
Storage Temperature	-65 °C to +150 °C
Operating Temperature	-40 °C to +85 °C

1. Exceeding any one or combination of these limits may cause permanent damage.
2. Ambient Temperature (T_A) = + 25°C
3. See temperature derating curve.

**Functional Block Diagram
(AMPS 824-849 MHz)**

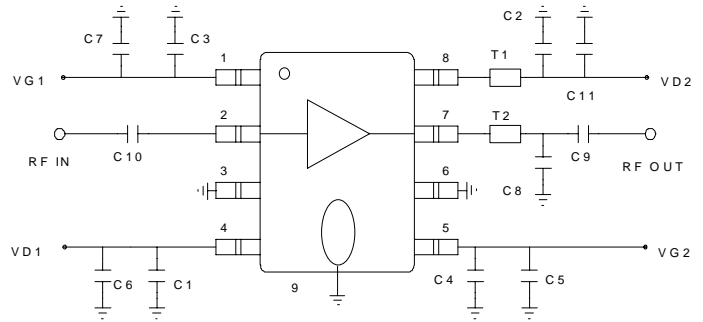

Pin Configuration

Pin No.	Pin Name	Description
1	V _{G1}	Negative supply voltage, First stage
2	RF IN	RF Input of the amplifier
3	GND	DC and RF Ground
4	V _{D1}	Positive supply voltage, First stage
5	V _{G2}	Negative supply voltage, First stage
6	GND	DC and RF Ground
7	RF OUT	RF Output of the amplifier
8	V _{D2}	Positive supply voltage, Second stage
9	Puck	DC and RF Ground

**External Circuitry Parts List
(AMPS 824-849 MHz)**

Part	Value	Purpose
C1 - C3	220 pF	By-Pass
C4 - C7	0.1 uF	By-Pass
C8	8 pF	Power Tuning
C9, C10	56 pF	DC Block
C11	1.0 uF	By-Pass
T1	0.470"	Matching Transmission
T2	0.250"	Lines (50 Ω)

- 1.) The recommended layout is specifically for the AMPS application. It shows EIA code size 0603 standard SMT capacitors with the exception of C11 which is a EIA code size 3528
- 2.) The location of C9, C10 and C11 is not critical to the performance of the amplifier.

Recommended PCB Configuration

Layout View (AMPS 824-849 MHz)

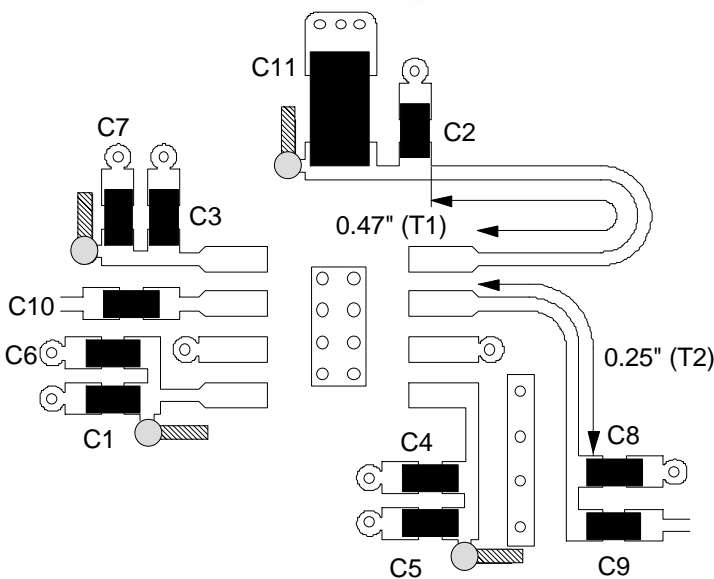

Cross Section View

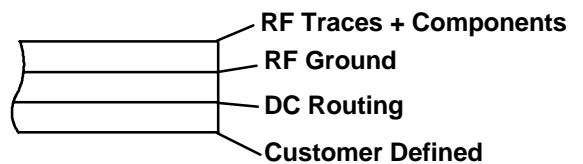

The PCB dielectric between RF traces and RF ground layers should be chosen to reduce RF discontinuities between 50 Ω lines and package pins. M/A-COM recommends an FR-4 dielectric thickness of 0.008"(0.2 mm) yielding a 50 Ω line width of 0.015"(0.38 mm). The recommended metalization thickness is 1 oz. copper and ground metalization thickness is 2 oz.. Shaded traces are vias to DC Routing layer and traces on DC Routing layer.

Biasing Procedure

The AM52-0001 requires that V_{GG} bias be applied prior to ANY V_{DD} bias. Permanent damage will occur if this procedure is not followed. All FETs in the PA will draw IDSS and damage internal circuitry. Resistance added in series with V_{g1} and V_{g2} may degrade performance.

Specifications Subject to Change Without Notice.

Typical Power Data (AMPS 824 - 849 MHz)

Test Conditions (unless otherwise noted) : $T_{Room} = +25^{\circ}C$, $T_{Cold} = -40^{\circ}C$, $T_{Hot} = +85^{\circ}C$, $P_{in} = 10\text{ dBm}$, Freq. = 835 MHz, $V_{DD} = V_{D1} = V_{D2} = 4.8V$ and $V_{GG} = V_{G1} = V_{G2}$ adjusted for 150 mA total quiescent drain current. External output matching circuitry is optimized for the 824 - 849 MHz AMPS application.

OUTPUT POWER VS INPUT POWER

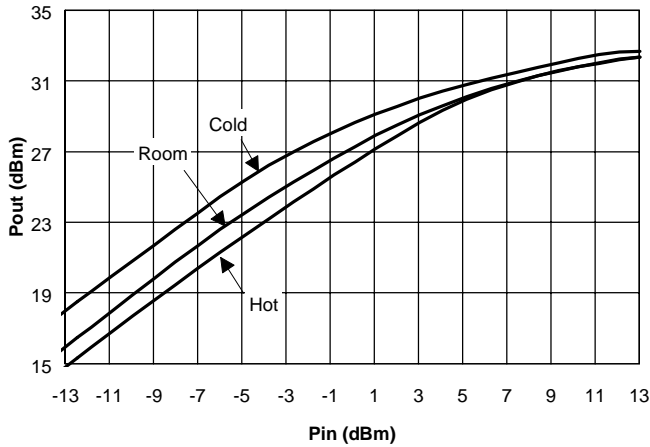

GAIN VS INPUT POWER

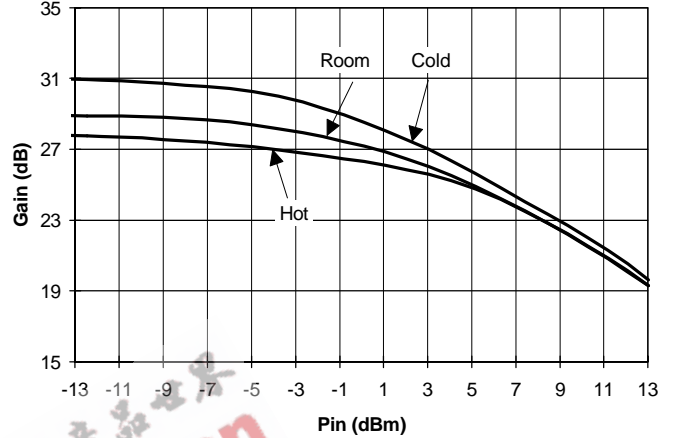

PAE VS INPUT POWER

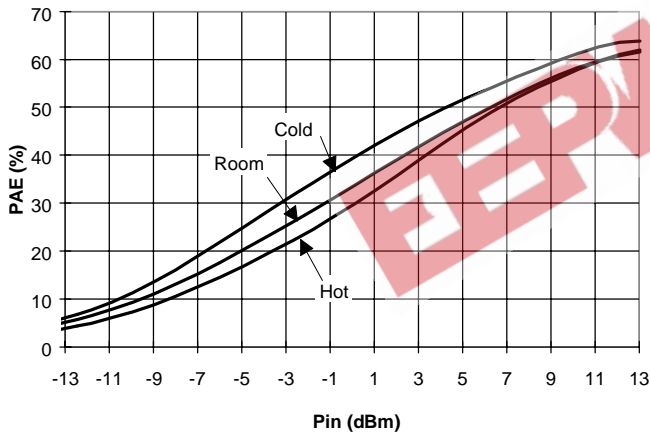

GATE CURRENT VS INPUT POWER

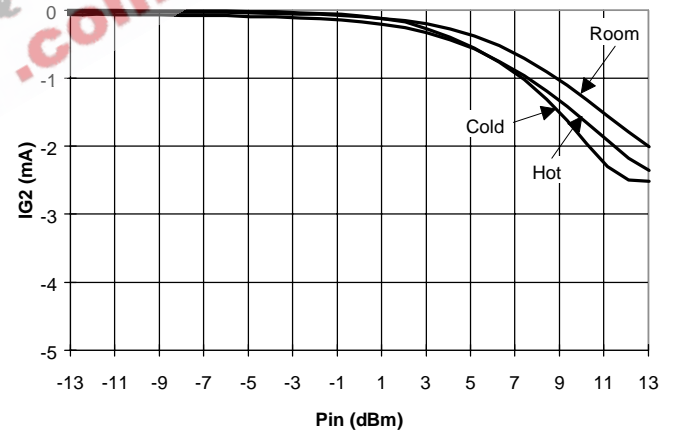

DRAIN CURRENTS VS INPUT POWER

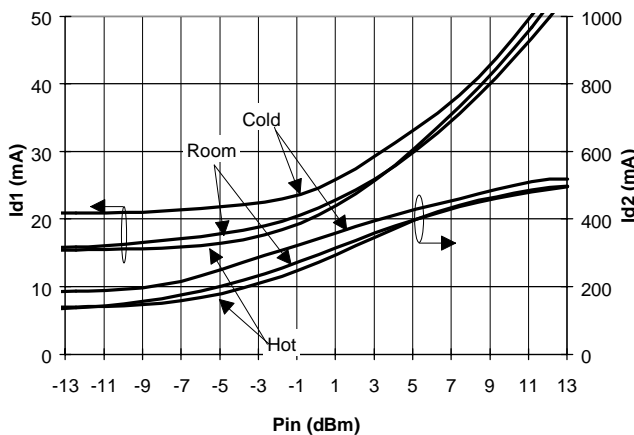

OUTPUT POWER VS FREQUENCY

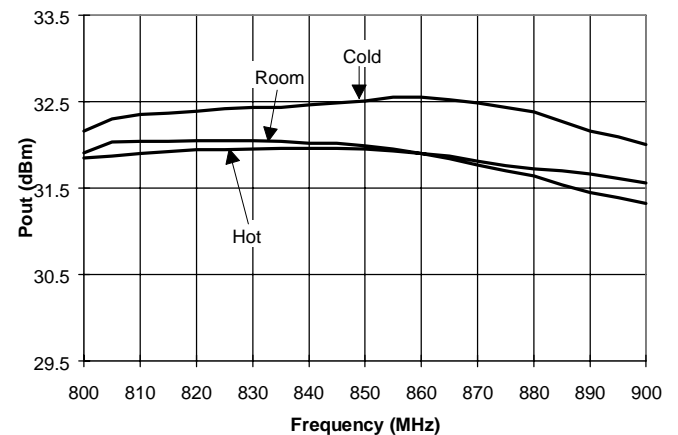

Specifications Subject to Change Without Notice.

Typical Power Data cont'd

PAE VS FREQUENCY

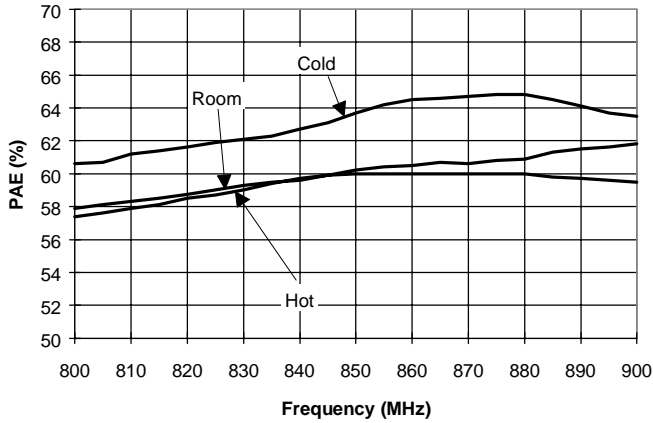

GAIN VS FREQUENCY

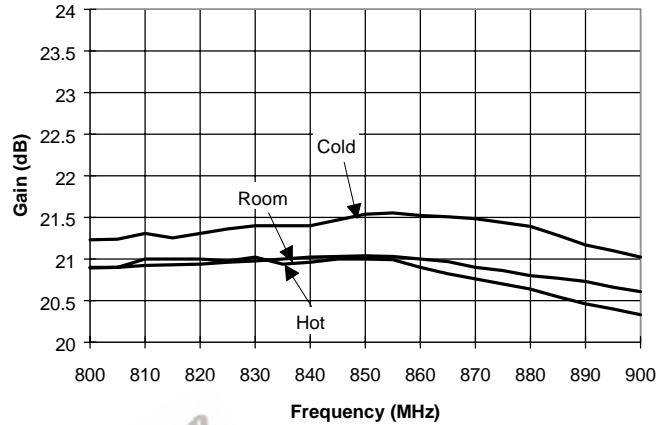

OUTPUT POWER, GAIN, AND PAE VS V_{DD}

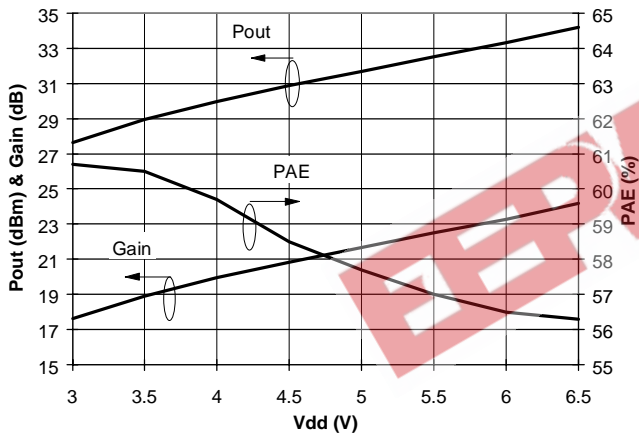

OUTPUT CONTROL POWER

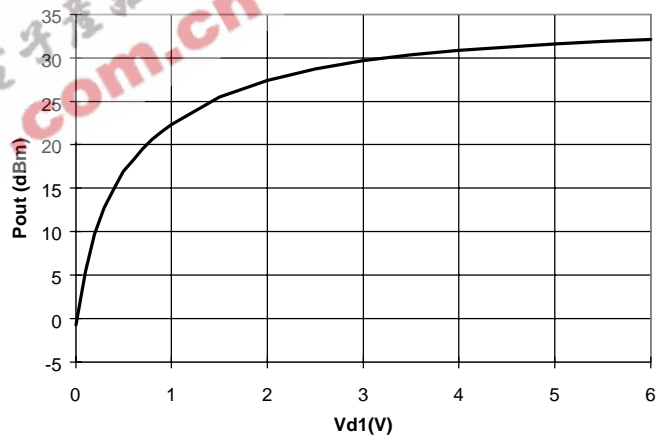

SECOND & THIRD HARMONICS VS FREQUENCY

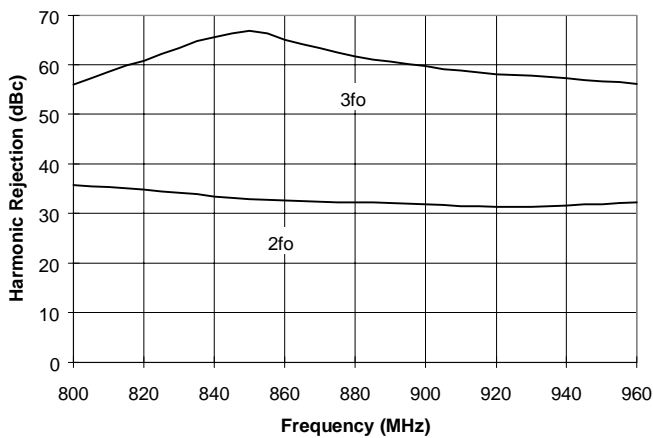

TEMPERATURE DERATING CURVE

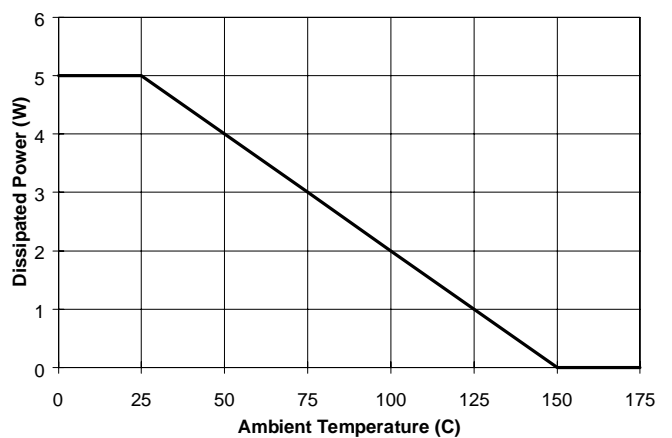

Note: Dissipated power in the above curve refers to power dissipated in output FET and is defined as (P_{diss}=V_{dd}*I_{d2}-P_{out}). Typical Thermal Resistance (θ_{jc}) = 25°C/W.

Specifications Subject to Change Without Notice.

Designer’s Kit AM52-0001SMB

The AM52-0001SMB Designer's Kit allows for immediate evaluation of M/A-COM's AM52-0001. The evaluation board consists of an AM52-0001, recommended external surface mount circuitry, RF connectors, and a DC multi-pin connector, all mounted to a multi-layer FR-4 PCB. Other items included in the Designer's Kit, a floppy disk (with typical performance data and a DXF file of

the recommended PCB layout) and any additional Application Notes. The AM52-0001SMB evaluation PCB is illustrated below with all functional ports labeled.

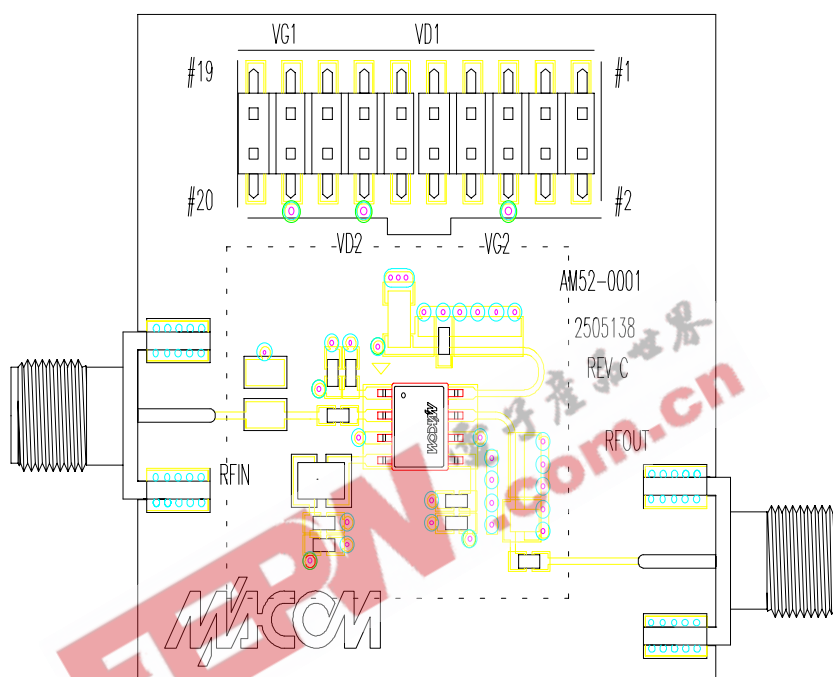

AMPLIFIER PCB

DC Connector Pinout

PCB DC Connector	Function	Device Pin Number	PCB DC Connector	Function	Device Pin Number
1	GND	6 & 9 (Puck)	11		
2			12		
3			13		
4			14	VD2	8
5			15		
6	VG2	5	16		
7			17	VG1	1
8			18		
9	VD1	4	19	GND	6 & 9 (Puck)
10			20		

Specifications Subject to Change Without Notice.

M/A-COM Inc.

North America: Tel. (800) 366-2266 ♦ Asia/Pacific: Tel. +81 3 3226-8761 ♦ Europe: Tel. +44 (1344) 869-595
 Fax (800) 618-8883 ♦ Fax +81 3 3226-8769 ♦ Fax +44 (1344) 300 020

Designer's Kit Biasing Procedure

In order to prevent transients which may damage the MMIC, please adhere to the following procedure.
Turn on all power supplies and set all voltages to 0 volts BEFORE connecting the power supplies to the DC connector.

Apply a -5.0 volt supply to DC connector pin 17 (V_{G1})
Apply a -5.0 volt supply to DC connector pin 6 (V_{G2})
Apply a +5.0 volt supply to the DC connector pin 9 (V_{D1})
Apply a +5.0 volt supply to the DC connector pin 14 (V_{D2})
Adjust all V_{GG} supplies to -5 volts
Adjust all V_{DD} supplies to +4.8 volts
Adjust $V_{GG} = V_{G1} = V_{G2}$ supply for desired V_{DD} quiescent current (typically 150 mA)

To power off, reverse above procedure

- 1) Set V_{D1} & V_{D2} to 0 volts
- 2) Set V_{G1} & V_{G2} to 0 volts
- 3) Disconnect bias lines from DC connector
- 4) Turn off power supplies

Evaluation PCB + RF Connector Losses

Port Reference	Loss (dB)
PA IN	0.1
PA OUT	0.1

The DC connector on the Designer's Kit PCB allows convenient DC line access. This is accomplished by one or more of the following methods:

1. A mating female multi-pin connector (Newark Electronics Stock # 46F-4658, not included)
2. Wires soldered to the necessary pins (not included)
3. Clip leads (not included)
4. A combination of clip leads or wires and jumpers (jumpers included as required).