

**1.5A ULTRA LOW DROPOUT LINEAR REGULATOR****AZ39150****General Description**

The AZ39150 is low dropout three-terminal regulator with a typical dropout of 375mV at 1.5A output current.

The AZ39150 provides current limit and thermal shutdown. On-chip thermal shutdown provides protection against any combination of high current and ambient temperature that would create excessive junction temperatures.

The AZ39150 is available for 3.3V and 5.0V versions now. It is available in the industry standard TO-220-3 and TO-263-3 power packages.

Features

- Minimum Guaranteed Output Current: 1.5A
- Dropout Voltage: 375mV at $I_{OUT}=1.5A$
- Output Accuracy: 1%
- Low Ground Current
- Internal Current Limit and Thermal Protection
- Reversed-battery and Reversed-lead Insertion Protection
- Fast Transient Response

Applications

- LCD TV
- Set Top Box
- LCD Monitor
- SMPS Post Regulator
- Laptop, Palmtop and Notebook
- Portable Instrumentation
- USB Power Supply

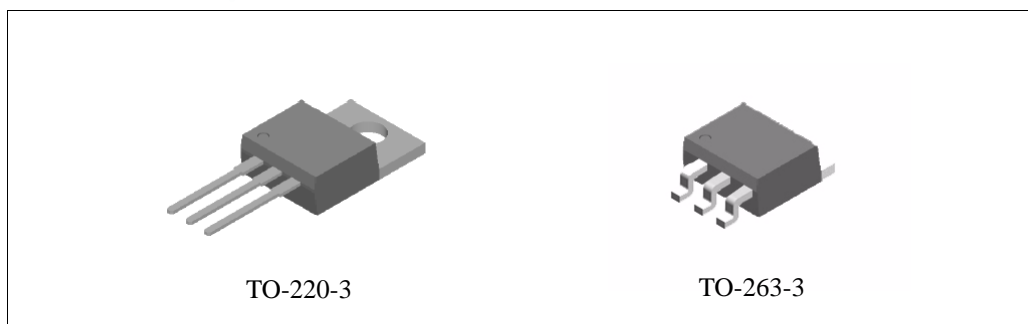

Figure 1. Package Types of AZ39150

**1.5A ULTRA LOW DROPOUT LINEAR REGULATOR****AZ39150****Pin Configuration**

Figure 2. Pin Configuration of AZ39150 (Top View)

Pin Description

Pin Number	Pin Name	Function
1	V_{IN}	Unregulated input.
2	GND	The ground pin. This pin and TAB are internally connected.
3	V_{OUT}	Regulated Output.

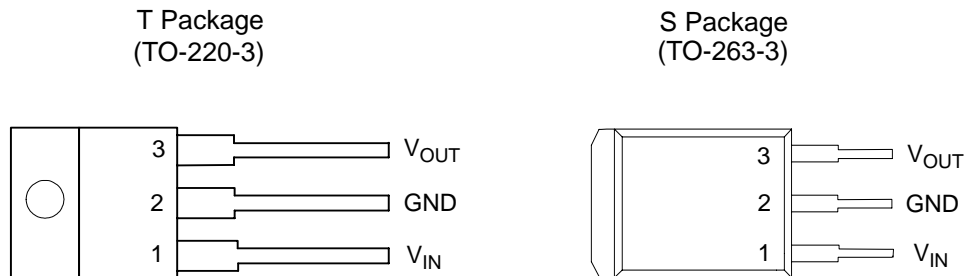

1.5A ULTRA LOW DROPOUT LINEAR REGULATOR

AZ39150

Functional Block Diagram

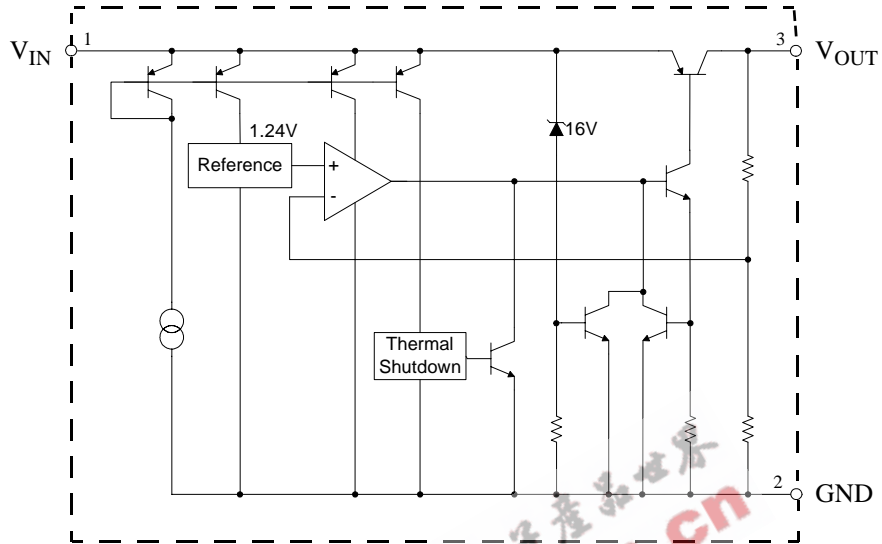
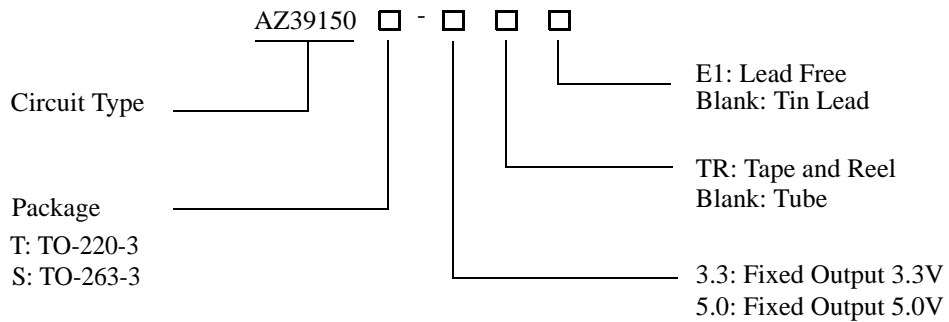

Figure 3. Functional Block Diagram of AZ39150

Ordering Information



**1.5A ULTRA LOW DROPOUT LINEAR REGULATOR****AZ39150****Ordering Information (Continued)**

Package	Temperature Range	Part Number		Marking ID		Packing Type
		Tin Lead	Lead Free	Tin Lead	Lead Free	
TO-220-3	-40 to 125°C	AZ39150T-3.3	AZ39150T-3.3E1	AZ39150T-3.3	AZ39150T-3.3E1	Tube
		AZ39150T-5.0	AZ39150T-5.0E1	AZ39150T-5.0	AZ39150T-5.0E1	Tube
TO-263-3	-40 to 125°C	AZ39150S-3.3	AZ39150S-3.3E1	AZ39150S-3.3	AZ39150S-3.3E1	Tube
		AZ39150S-3.3TR	AZ39150S-3.3TRE1	AZ39150S-3.3	AZ39150S-3.3E1	Tape & Reel
		AZ39150S-5.0	AZ39150S-5.0E1	AZ39150S-5.0	AZ39150S-5.0E1	Tube
		AZ39150S-5.0TR	AZ39150S-5.0TRE1	AZ39150S-5.0	AZ39150S-5.0E1	Tape & Reel

BCD Semiconductor's Pb-free products, as designated with "E1" suffix in the part number, are RoHS compliant.

Absolute Maximum Ratings (Note 1)

Parameter	Symbol	Value	Unit
Supply Voltage	V_{IN}	15	V
Maximum Operating Junction Temperature	T_J	150	°C
Storage Temperature Range	T_{STG}	-65 to 150	°C
Lead Temperature (Soldering, 10sec)	T_{LEAD}	300	°C
ESD (Machine Model)		300	V

Note 1: Stresses greater than those listed under "Absolute Maximum Ratings" may cause permanent damage to the device. These are stress ratings only, and functional operation of the device at these or any other conditions beyond those indicated under "Recommended Operating Conditions" is not implied. Exposure to "Absolute Maximum Ratings" for extended periods may affect device reliability.

Recommended Operating Conditions

Parameter	Symbol	Min	Max	Unit
Supply Voltage	V_{IN}		13.2	V
Operating Junction Temperature	T_J	-40	125	°C



1.5A ULTRA LOW DROPOUT LINEAR REGULATOR

AZ39150

Electrical Characteristics

AZ39150-3.3V Electrical Characteristics

Operating Conditions: $V_{IN}=4.3V$, $I_{OUT}=10mA$, $C_{IN}=10\mu F$, $C_{OUT}=10\mu F$, $T_J=25^\circ C$, unless otherwise specified. The **Boldface** applies over $-40^\circ C \leq T_J \leq 125^\circ C$.

Parameter	Symbol	Condition	Min	Typ	Max	Unit	
Output Voltage	V_{OUT}	$I_{OUT}=10mA$	3.27	3.3	3.33	V	
		$10mA \leq I_{OUT} \leq 1.5A$, $4.3V \leq V_{IN} \leq 8V$	3.23	3.3	3.37	V	
Line Regulation	V_{RLINE}	$I_{OUT}=10mA$, $4.3V \leq V_{IN} \leq 8V$		2	17	mV	
Load Regulation	V_{RLOAD}	$V_{IN}=4.3V$, $10mA \leq I_{OUT} \leq 1.5A$		6.6	33	mV	
Output Voltage Temperature Coefficient	$\Delta V_{OUT}/\Delta T$	$I_{OUT}=10mA$		66	330	$\mu V/^\circ C$	
Dropout Voltage (Note 2)	V_{DROP}	$\Delta V_{OUT}=1\%$	$I_{OUT}=100mA$		80	200	mV
			$I_{OUT}=750mA$		260		mV
			$I_{OUT}=1.5A$		375	500	mV
Ground Current	I_{GND}	$I_{OUT}=750mA$, $V_{IN}=4.3V$		4	20	mA	
		$I_{OUT}=1.5A$, $V_{IN}=4.3V$		17		mA	
Current Limit	I_{LIMIT}	$V_{OUT}=0V$ (Note 3)	2.0	2.8		A	
Minimum Load Current	$I_{LOAD(MIN)}$			7	10	mA	
Output Noise Voltage (rms)		10Hz to 100KHz, $I_{OUT}=100mA$, $C_{OUT}=10\mu F$		400		μV	

Note 2: Dropout voltage is defined as the input-to-output differential when the output voltage drops to 99% of its nominal value which is measured at $V_{OUT}+1V$ applied to V_{IN} .

Note 3: $V_{IN}=V_{OUT(NOMINAL)}+1V$.



1.5A ULTRA LOW DROPOUT LINEAR REGULATOR

AZ39150

Electrical Characteristics (Continued)

AZ39150-5.0V Electrical Characteristics

Operating Conditions: $V_{IN}=6V$, $I_{OUT}=10mA$, $C_{IN}=10\mu F$, $C_{OUT}=10\mu F$, $T_J=25^\circ C$, unless otherwise specified. The **Boldface** applies over $-40^\circ C \leq T_J \leq 125^\circ C$.

Parameter	Symbol	Condition	Min	Typ	Max	Unit	
Output Voltage	V_{OUT}	$I_{OUT}=10mA$	4.95	5.0	5.05	V	
		$10mA \leq I_{OUT} \leq 1.5A$, $6V \leq V_{IN} \leq 8V$	4.90	5.0	5.10	V	
Line Regulation	V_{RLINE}	$I_{OUT}=10mA$, $6V \leq V_{IN} \leq 8V$		3	25	mV	
Load Regulation	V_{RLOAD}	$V_{IN}=6V$, $10mA \leq I_{OUT} \leq 1.5A$		10	50	mV	
Output Voltage Temperature Coefficient	$\Delta V_{OUT}/\Delta T$	$I_{OUT}=10mA$		100	500	$\mu V/^\circ C$	
Dropout Voltage (Note 2)	V_{DROP}	$\Delta V_{OUT}=1\%$	$I_{OUT}=100mA$		80	200	mV
			$I_{OUT}=750mA$		260		mV
			$I_{OUT}=1.5A$		375	500	mV
Ground Current	I_{GND}	$I_{OUT}=750mA$, $V_{IN}=6V$		4	20	mA	
		$I_{OUT}=1.5A$, $V_{IN}=6V$		17		mA	
Current Limit	I_{LIMIT}	$V_{OUT}=0V$ (Note 3)	2.0	2.8		A	
Minimum Load Current	$I_{LOAD (MIN)}$			7	10	mA	
Output Noise Voltage (rms)		10Hz to 100KHz, $I_{OUT}=100mA$, $C_{OUT}=10\mu F$		400		μV	

Note 2: Dropout voltage is defined as the input-to-output differential when the output voltage drops to 99% of its nominal value which is measured at $V_{OUT}+1V$ applied to V_{IN} .

Note 3: $V_{IN}=V_{OUT(NOMINAL)}+1V$.



1.5A ULTRA LOW DROPOUT LINEAR REGULATOR

AZ39150

Typical Performance Characteristics

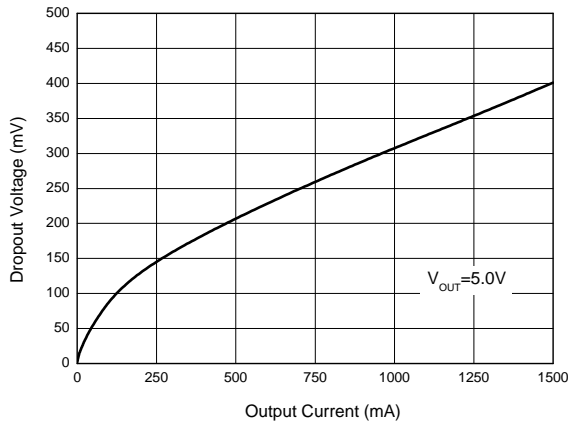

Figure 4. Dropout Voltage vs. Output Current

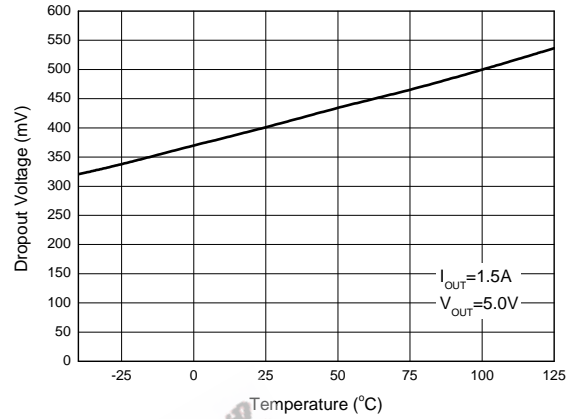

Figure 5. Dropout Voltage vs. Temperature

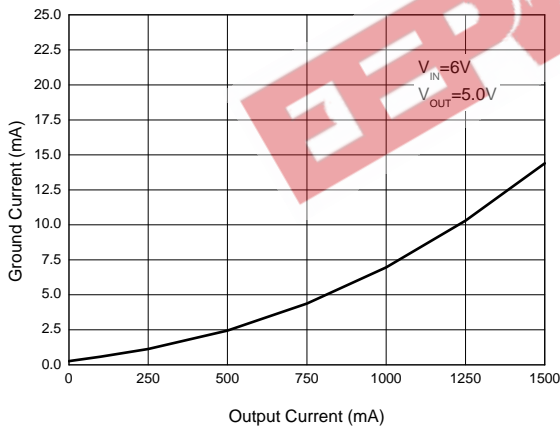

Figure 6. Ground Current vs. Output Current

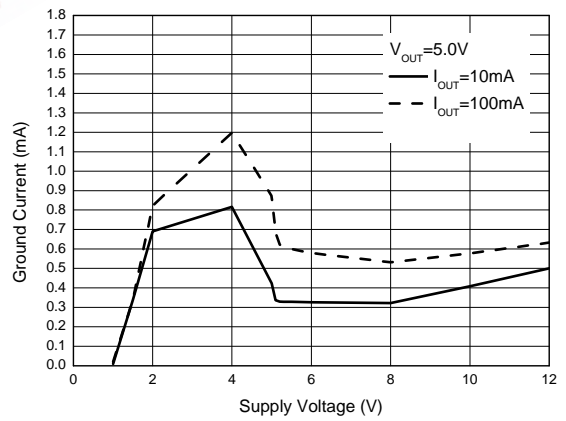

Figure 7. Ground Current vs. Supply Voltage



1.5A ULTRA LOW DROPOUT LINEAR REGULATOR

AZ39150

Typical Performance Characteristics (Continued)

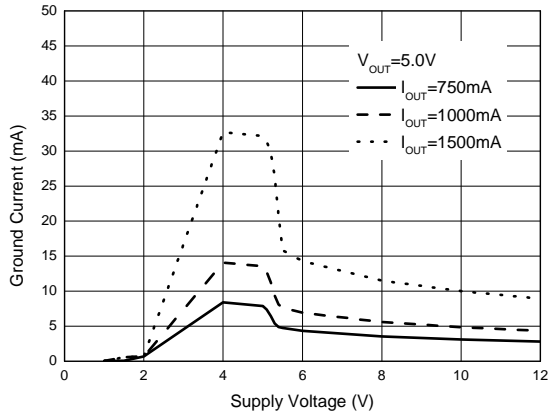

Figure 8. Ground Current vs. Supply Voltage

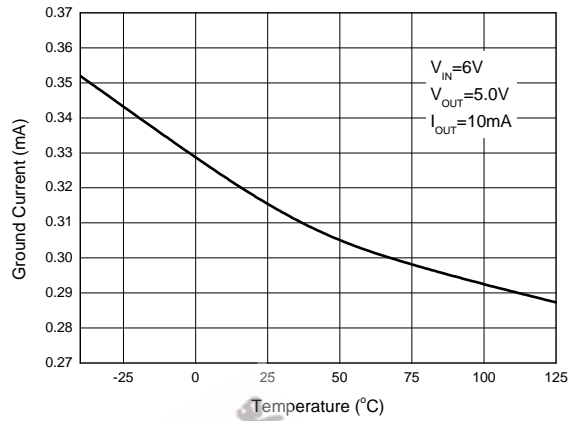

Figure 9. Ground Current vs. Temperature

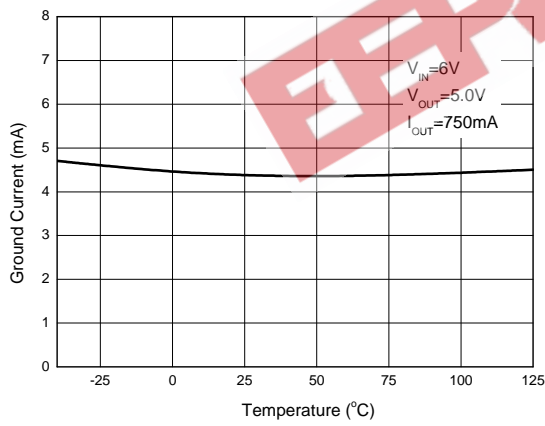

Figure 10. Ground Current vs. Temperature

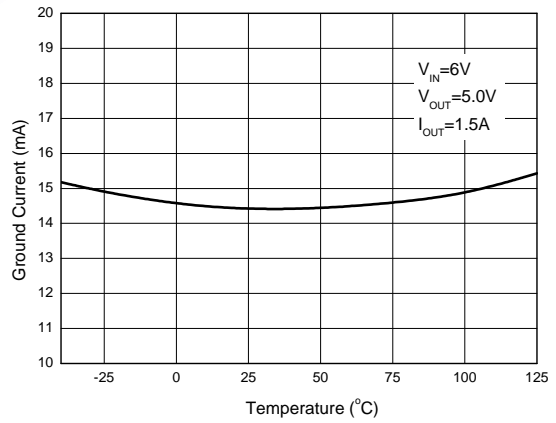

Figure 11. Ground Current vs. Temperature



1.5A ULTRA LOW DROPOUT LINEAR REGULATOR

AZ39150

Typical Performance Characteristics (Continued)

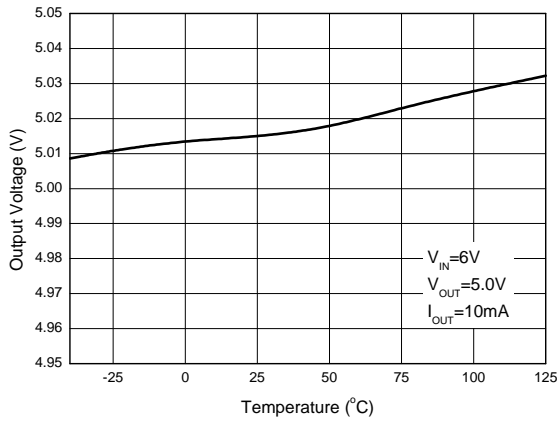

Figure 12. Output Voltage vs. Temperature

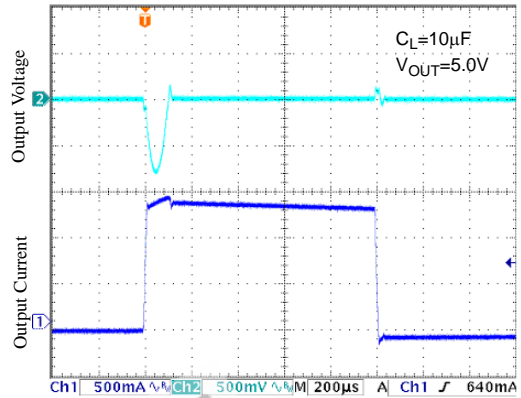

Figure 13. Load Transient

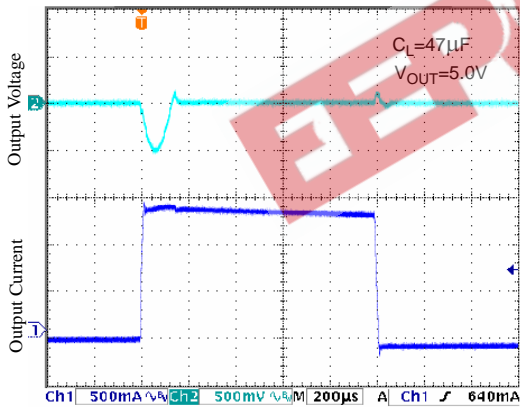

Figure 14. Load Transient

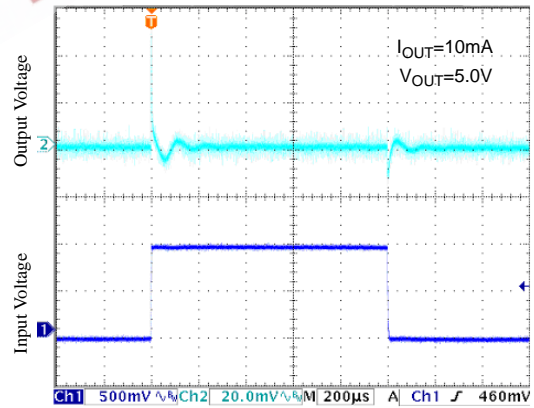

Figure 15. Line Transient



1.5A ULTRA LOW DROPOUT LINEAR REGULATOR

AZ39150

Typical Application

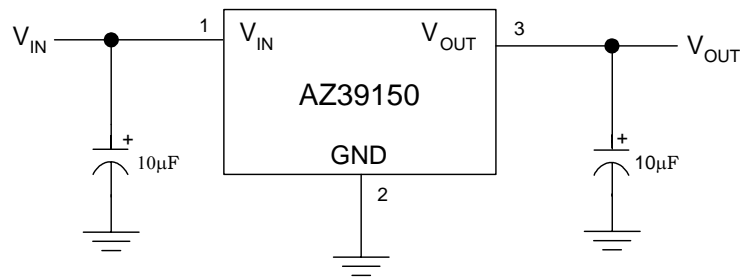

Figure 16. Typical Application of AZ39150

EEPW.com.cn 电子产业世界



1.5A ULTRA LOW DROPOUT LINEAR REGULATOR

AZ39150

Mechanical Dimensions

TO-220-3

Unit: mm(inch)

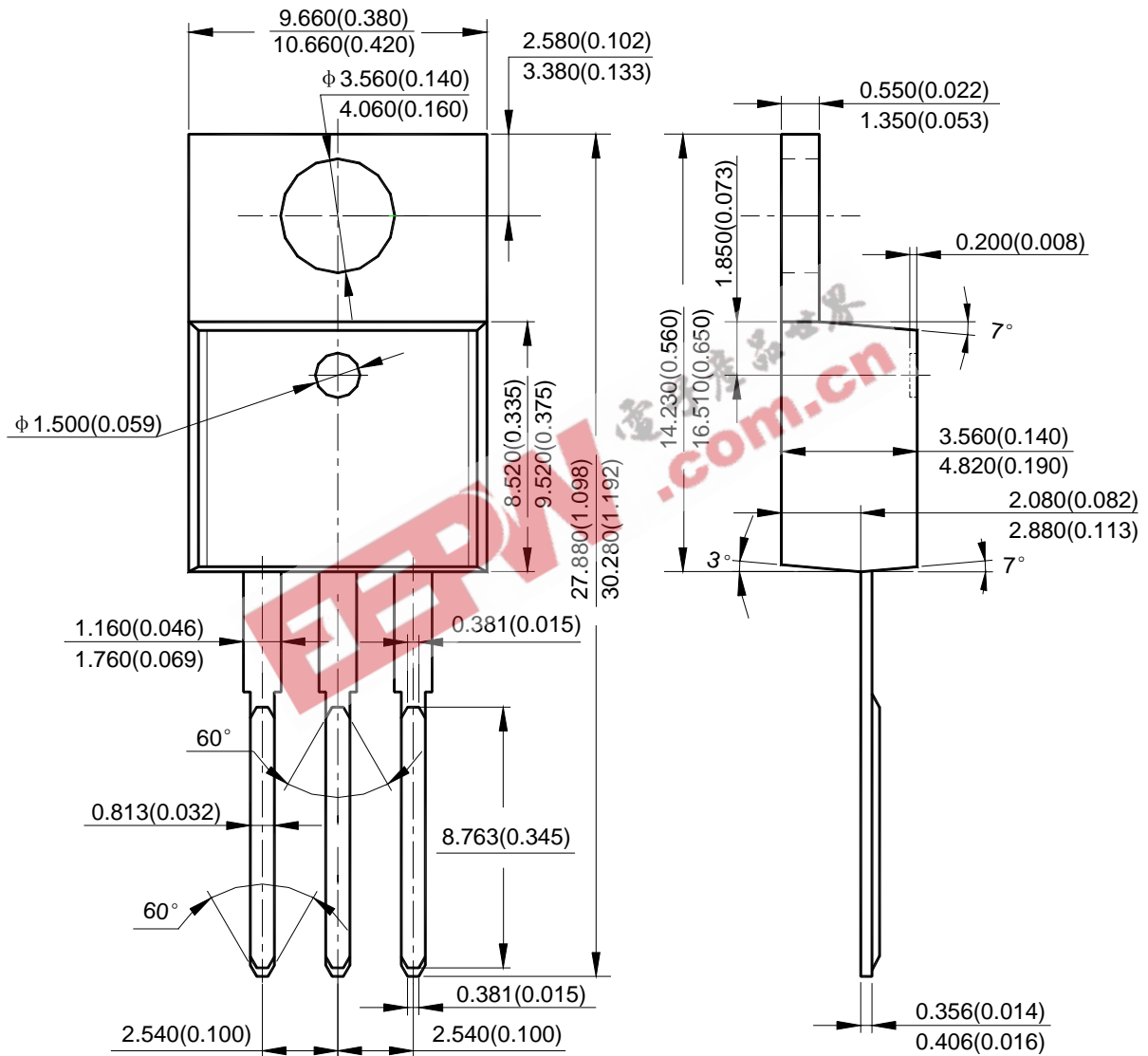



1.5A ULTRA LOW DROPOUT LINEAR REGULATOR

AZ39150

Mechanical Dimensions (Continued)

TO-263-3

Unit: mm(inch)

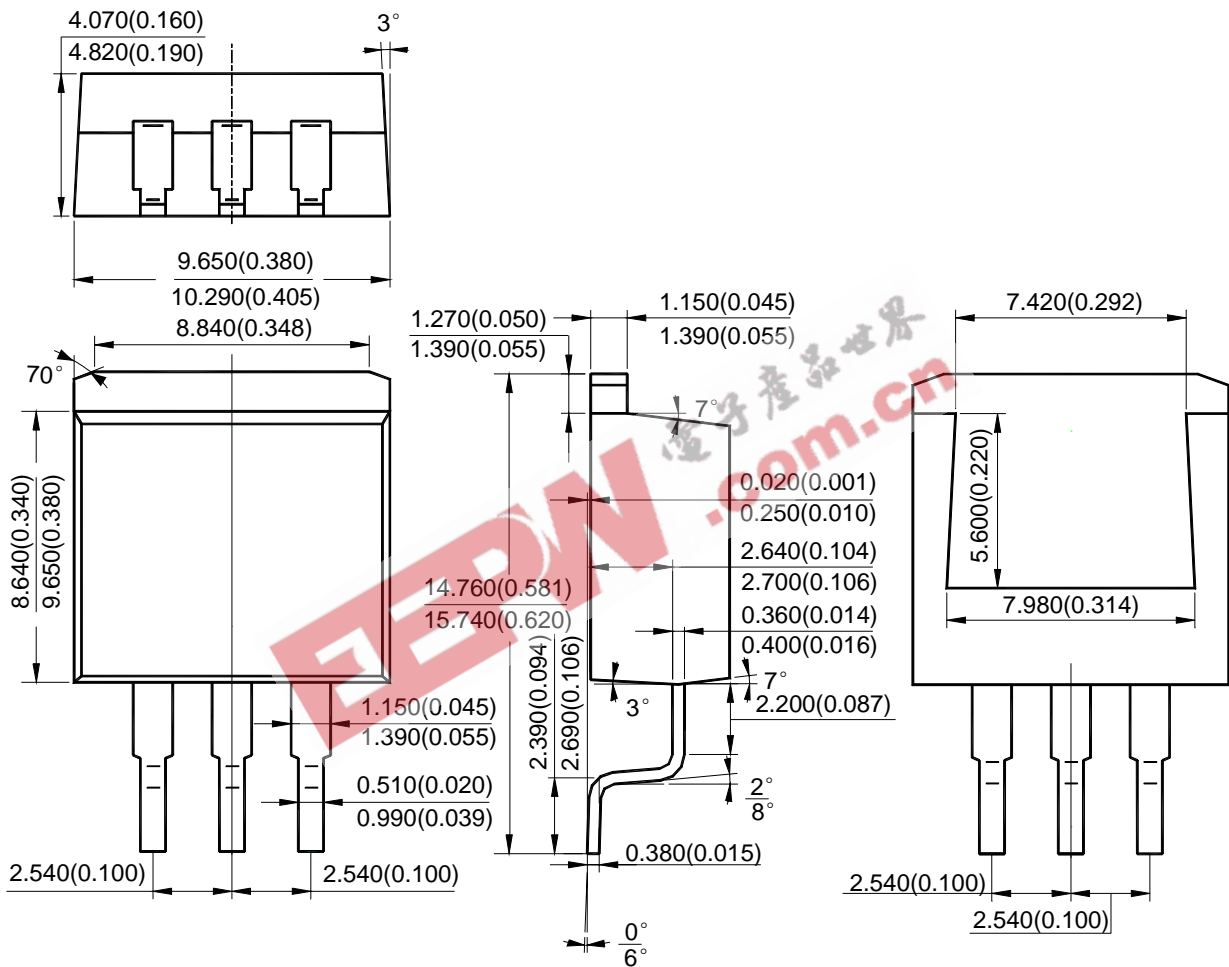



BCD Semiconductor Manufacturing Limited

<http://www.bcdsemi.com>

EEPW.com.cn
电子世界

BCD Semiconductor Corporation

3170 De La Cruz Blvd, Suite # 105 Santa Clara, CA 95054-2411, U.S.A

Tel: +1-408-988 6388, Fax: +1-408-988 6386

Shanghai SIM-BCD Semiconductor Manufacturing Co., Ltd.

800 Yi Shan Road, Shanghai 200233, PRC

Tel: +86-21-6485-1491, Fax: +86-21-5450-0008

Advanced Analog Circuits (Shanghai) Corporation

8F, B Zone, 900 Yi Shan Road, Shanghai 200233, PRC

Tel: +86-21-6495 9539, Fax: +86-21-6485 9673

BCD Semiconductor (Taiwan) Company Limited

Room 2210, 22nd Fl, 333, Keelung Road, Sec. 1, TaiPei (110), Taiwan

Tel: +886-2-2758 6828, Fax: +886-2-2758 6892

IMPORTANT NOTICE

BCD Semiconductor Manufacturing Limited reserves the right to make changes without further notice to any products or specifications herein. BCD Semiconductor Manufacturing Limited does not assume any responsibility for use of any its products for any particular purpose, nor does BCD Semiconductor Manufacturing Limited assume any liability arising out of the application or use of any its products or circuits. BCD Semiconductor Manufacturing Limited does not convey any license under its patent rights or other rights nor the rights of others.