



M29F102BB

1 Mbit (64Kb x16, Boot Block) Single Supply Flash Memory

FEATURES SUMMARY

- SINGLE 5V±10% SUPPLY VOLTAGE for PROGRAM, ERASE and READ OPERATIONS
- ACCESS TIME: 35ns
- PROGRAMMING TIME
 - 8µs per Word typical
- 5 MEMORY BLOCKS
 - 1 Boot Block (Bottom Location)
 - 2 Parameter and 2 Main Blocks
- PROGRAM/ERASE CONTROLLER
 - Embedded Word Program algorithm
 - Embedded Multi-Block/Chip Erase algorithm
 - Status Register Polling and Toggle Bits
- ERASE SUSPEND and RESUME MODES
 - Read and Program another Block during Erase Suspend
- UNLOCK BYPASS PROGRAM COMMAND
 - Faster Production/Batch Programming
- TEMPORARY BLOCK UNPROTECTION MODE
- LOW POWER CONSUMPTION
 - Standby and Automatic Standby
- 100,000 PROGRAM/ERASE CYCLES per BLOCK
- M28F102 COMPATIBLE
 - Pin-out and Read Mode
- 20 YEARS DATA RETENTION
 - Defectivity below 1 ppm/year
- ELECTRONIC SIGNATURE
 - Manufacturer Code: 0020h
 - Bottom Device Code M29F102BB: 0097h
- PACKAGES
 - Compliant with Lead-Free Soldering Processes
 - Lead-Free Versions

Figure 1. Package

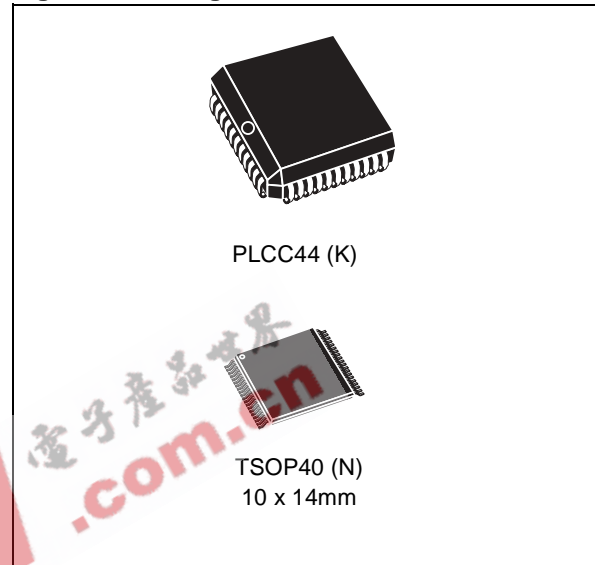

TABLE OF CONTENTS

FEATURES SUMMARY	1
Figure 1. Package	1
SUMMARY DESCRIPTION	4
Figure 2. Logic Diagram	4
Table 1. Signal Names	4
Table 2. Bottom Boot Block Addresses, M29F102BB	4
Figure 3. PLCC Connections	5
Figure 4. TSOP Connections	5
SIGNAL DESCRIPTIONS	6
Address Inputs (A0-A15)	6
Data Inputs/Outputs (DQ0-DQ15)	6
Chip Enable (\overline{E})	6
Output Enable (\overline{G})	6
Write Enable (\overline{W})	6
Reset/Block Temporary Unprotect (\overline{RP})	6
V _{CC} Supply Voltage	6
V _{SS} Ground	6
BUS OPERATIONS	7
Bus Read	7
Bus Write	7
Output Disable	7
Standby	7
Automatic Standby	7
Special Bus Operations	7
Electronic Signature	7
Block Protection and Blocks Unprotection	7
Table 3. Bus Operations	7
COMMAND INTERFACE	8
Read/Reset Command	8
Auto Select Command	8
Program Command	8
Unlock Bypass Command	8
Unlock Bypass Program Command	8
Unlock Bypass Reset Command	8
Chip Erase Command	9
Block Erase Command	9
Erase Suspend Command	9
Erase Resume Command	9
Table 4. Commands	10

Table 5. Program, Erase Times and Program, Erase Endurance Cycles ($T_A = 0$ to 70°C)	10
STATUS REGISTER	11
Data Polling Bit (DQ7).	11
Toggle Bit (DQ6)..	11
Error Bit (DQ5).	11
Erase Timer Bit (DQ3).	11
Alternative Toggle Bit (DQ2)..	11
Table 6. Status Register Bits	12
Figure 5. Data Polling Flowchart.	12
Figure 6. Data Toggle Flowchart.	12
MAXIMUM RATINGS	13
Table 7. Absolute Maximum Ratings (1)	13
DC AND AC PARAMETERS	14
Table 8. Operating and AC Measurement Conditions	14
Figure 7. AC Testing Input Output Waveform.	14
Figure 8. AC Testing Load Circuit.	14
Table 9. Capacitance ($T_A = 25^\circ\text{C}$, $f = 1\text{ MHz}$)	14
Table 10. DC Characteristics ($T_A = 0$ to 70°C)	15
Table 11. Read AC Characteristics ($T_A = 0$ to 70°C)	16
Figure 9. Read Mode AC Waveforms.	16
Table 12. Write AC Characteristics, Write Enable Controlled ($T_A = 0$ to 70°C)	17
Figure 10. Write AC Waveforms, Write Enable Controlled.	17
Table 13. Write AC Characteristics, Chip Enable Controlled ($T_A = 0$ to 70°C)	18
Figure 11. Write AC Waveforms, Chip Enable Controlled	18
Table 14. Reset/Block Temporary Unprotect AC Characteristics ($T_A = 0$ to 70°C)	19
Figure 12. Reset/Block Temporary Unprotect AC Waveforms.	19
PACKAGE MECHANICAL	20
Figure 13. PLCC44 - 44 lead Plastic Leaded Chip Carrier, Package Outline	20
Table 15. PLCC44 - 44 lead Plastic Leaded Chip Carrier, Package Mechanical Data	20
Figure 14. TSOP40 - 40 lead Plastic Thin Small Outline, 10 x 14mm, Package Outline	21
Table 16. PTSOP40 - 40 lead Plastic Thin Small Outline, 10 x 14mm, Package Mechanical Data	21
ORDERING INFORMATION SCHEME	22
Table 17. Ordering Information Scheme	22
REVISION HISTORY	23
Table 18. Revision History.	23

SUMMARY DESCRIPTION

The M29F102BB is a 1 Mbit (64Kb x16) non-volatile memory that can be read, erased and reprogrammed. These operations can be performed using a single 5V supply. On power-up the memory defaults to its Read mode where it can be read in the same way as a ROM or EPROM.

The memory is divided into blocks that can be erased independently so it is possible to preserve valid data while old data is erased. Each block can be protected independently to prevent accidental Program or Erase commands from modifying the memory. Program and Erase commands are written to the Command Interface of the memory. An on-chip Program/Erase Controller simplifies the process of programming or erasing the memory by taking care of all of the special operations that are required to update the memory contents. The end of a program or erase operation can be detected and any error conditions identified. The command set required to control the memory is consistent with JEDEC standards.

The blocks in the memory are asymmetrically arranged, see [Table 2., Bottom Boot Block Addresses, M29F102BB](#). The first 32 Kwords have been divided into four additional blocks. The 8 Kword Boot Block can be used for small initialization code to start the microprocessor, the two 4 Kword Parameter Blocks can be used for parameter storage and the remaining 16 Kwords are a small Main Block where the application may be stored.

Chip Enable, Output Enable and Write Enable signals control the bus operation of the memory. They allow simple connection to most microprocessors, often without additional logic.

The memory is offered in PLCC44 and TSOP40 (10 x 14mm) packages. In addition to the standard version, the packages are also available in Lead-free version, in compliance with JEDEC Std J-STD-020B, the ST ECOPACK 7191395 Specification, and the RoHS (Restriction of Hazardous Substances) directive. All packages are compliant with Lead-free soldering processes.

The memory is supplied with all the bits erased (set to '1').

Figure 2. Logic Diagram

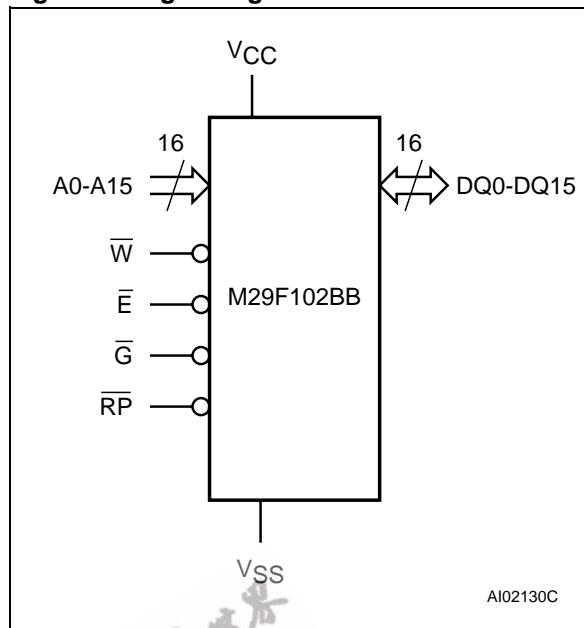

Table 1. Signal Names

A0-A15	Address Inputs
DQ0-DQ15	Data Inputs/Outputs
\bar{E}	Chip Enable
\bar{G}	Output Enable
\bar{W}	Write Enable
\bar{RP}	Reset/Block Temporary Unprotect
Vcc	Supply Voltage
Vss	Ground
NC	Not Connected Internally

Table 2. Bottom Boot Block Addresses, M29F102BB

#	Size (KWords)	Address Range
4	32	8000h-FFFFh
3	16	4000h-7FFFh
2	4	3000h-3FFFh
1	4	2000h-2FFFh
0	8	0000h-1FFFh

Figure 3. PLCC Connections

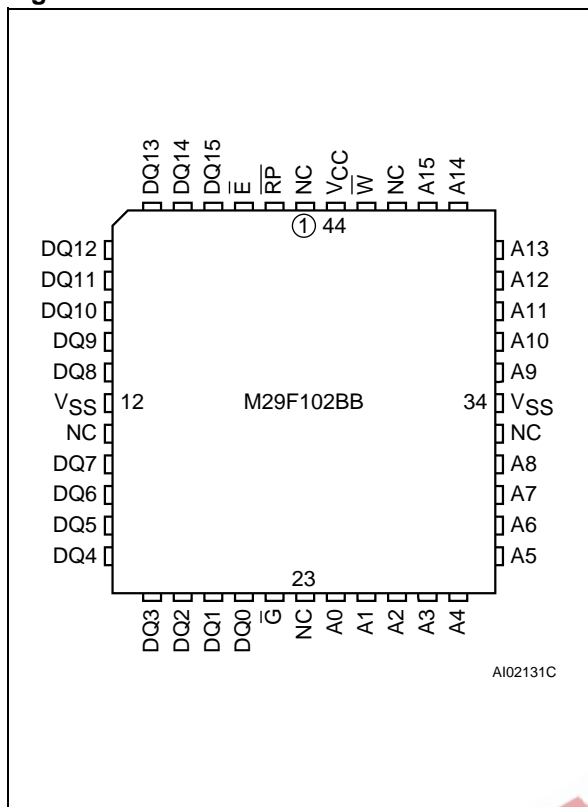
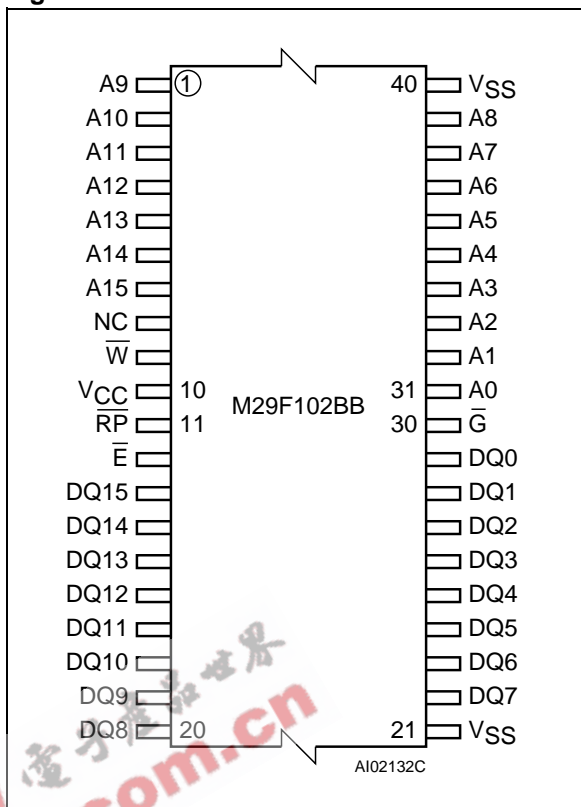

Figure 4. TSOP Connections



SIGNAL DESCRIPTIONS

See [Figure 2., Logic Diagram](#), and [Table 1., Signal Names](#), for a brief overview of the signals connected to this device.

Address Inputs (A0-A15). The Address Inputs select the cells in the memory array to access during Bus Read operations. During Bus Write operations they control the commands sent to the Command Interface of the internal state machine.

Data Inputs/Outputs (DQ0-DQ15). The Data Inputs/Outputs output the data stored at the selected address during a Bus Read operation. During Bus Write operations DQ0-DQ7 represent the commands sent to the Command Interface of the internal state machine; the Command Interface does not use DQ8-DQ15 to decode the commands.

Chip Enable (\bar{E}). The Chip Enable, \bar{E} , activates the memory, allowing Bus Read and Bus Write operations to be performed. When Chip Enable is High, V_{IH} , all other pins are ignored.

Output Enable (\bar{G}). The Output Enable, \bar{G} , controls the Bus Read operation of the memory.

Write Enable (\bar{W}). The Write Enable, \bar{W} , controls the Bus Write operation of the memory's Command Interface.

Reset/Block Temporary Unprotect (\bar{RP}). The Reset/Block Temporary Unprotect pin can be used to apply a Hardware Reset to the memory or to temporarily unprotect all blocks that have been protected.

A Hardware Reset is achieved by holding Reset/Block Temporary Unprotect Low, V_{IL} , for at least t_{PLPX} . After Reset/Block Temporary Unprotect goes High, V_{IH} , the memory will be ready for Bus

Read and Bus Write operations after t_{PHEL} or t_{PLYH} , whichever occurs last. See [Table 13., Write AC Characteristics, Chip Enable Controlled \(TA = 0 to 70 °C\)](#) and [Figure 12., Reset/Block Temporary Unprotect AC Waveforms](#).

Holding \bar{RP} at V_{ID} will temporarily unprotect the protected blocks in the memory. Program and Erase operations on all blocks will be possible. The transition from V_{IH} to V_{ID} must be slower than t_{PHPHH} .

Reset/Block Temporary Unprotect can be left unconnected. A weak internal pull-up resistor ensures that the memory always operates correctly.

V_{CC} Supply Voltage. The V_{CC} Supply Voltage supplies the power for all operations (Read, Program, Erase etc.).

The Command Interface is disabled when the V_{CC} Supply Voltage is less than the Lockout Voltage, V_{LKO} . This prevents Bus Write operations from accidentally damaging the data during power up, power down and power surges. If the Program/Erase Controller is programming or erasing during this time then the operation aborts and the memory contents being altered will be invalid.

A 0.1µF capacitor should be connected between the V_{CC} Supply Voltage pin and the V_{SS} Ground pin to decouple the current surges from the power supply. The PCB track widths must be sufficient to carry the currents required during program and erase operations, I_{CC3}.

V_{SS} Ground. The V_{SS} Ground is the reference for all voltage measurements.

BUS OPERATIONS

There are five standard bus operations that control the device. These are Bus Read, Bus Write, Output Disable, Standby and Automatic Standby. See [Table 3., Bus Operations](#), for a summary. Typically glitches of less than 5ns on Chip Enable or Write Enable are ignored by the memory and do not affect bus operations.

Bus Read. Bus Read operations read from the memory cells, or specific registers in the Command Interface. A valid Bus Read operation involves setting the desired address on the Address Inputs, applying a Low signal, V_{IL} , to Chip Enable and Output Enable and keeping Write Enable High, V_{IH} . The Data Inputs/Outputs will output the value, see [Figure 9., Read Mode AC Waveforms](#), and [Table 11., Read AC Characteristics \(TA = 0 to 70°C\)](#), for details of when the output becomes valid.

Bus Write. Bus Write operations write to the Command Interface. A valid Bus Write operation begins by setting the desired address on the Address Inputs. The Address Inputs are latched by the Command Interface on the falling edge of Chip Enable or Write Enable, whichever occurs last. The Data Inputs/Outputs are latched by the Command Interface on the rising edge of Chip Enable or Write Enable, whichever occurs first. Output Enable must remain High, V_{IH} , during the whole Bus Write operation. See [Figures 10 and 11, Write AC Waveforms](#), and [Tables 12 and 13, Write AC Characteristics](#), for details of the timing requirements.

Output Disable. The Data Inputs/Outputs are in the high impedance state when Output Enable is High, V_{IH} .

Standby. When Chip Enable is High, V_{IH} , the memory enters Standby mode and the Data Inputs/Outputs pins are placed in the high-impedance state. To reduce the Supply Current to the

Standby Supply Current, I_{CC2} , Chip Enable should be held within $V_{CC} \pm 0.2V$. For the Standby current level see [Table 10., DC Characteristics \(TA = 0 to 70°C\)](#).

During program or erase operations the memory will continue to use the Program/Erase Supply Current, I_{CC3} , for Program or Erase operations until the operation completes.

Automatic Standby. If CMOS levels ($V_{CC} \pm 0.2V$) are used to drive the bus and the bus is inactive for 150ns or more the memory enters Automatic Standby where the internal Supply Current is reduced to the Standby Supply Current, I_{CC2} . The Data Inputs/Outputs will still output data if a Bus Read operation is in progress.

Special Bus Operations

Additional bus operations can be performed to read the Electronic Signature and also to apply and remove Block Protection. These bus operations are intended for use by programming equipment and are not usually used in applications. They require V_{ID} to be applied to some pins.

Electronic Signature. The memory has two codes, the manufacturer code and the device code, that can be read to identify the memory. These codes can be read by applying the signals listed in [Table 3., Bus Operations](#).

Block Protection and Blocks Unprotection. Each block can be separately protected against accidental Program or Erase. Protected blocks can be unprotected to allow data to be changed.

There are two methods available for protecting and unprotecting the blocks, one for use on programming equipment and the other for in-system use. For further information refer to Application Note AN1122, Applying Protection and Unprotection to M29 Series Flash.

Table 3. Bus Operations

Operation	\bar{E}	\bar{G}	\bar{W}	Address Inputs	Data Inputs/Outputs
Bus Read	V_{IL}	V_{IL}	V_{IH}	Cell Address	Data Output
Bus Write	V_{IL}	V_{IH}	V_{IL}	Command Address	Data Input
Output Disable	X	V_{IH}	V_{IH}	X	Hi-Z
Standby	V_{IH}	X	X	X	Hi-Z
Read Manufacturer Code	V_{IL}	V_{IL}	V_{IH}	A0 = V_{IL} , A1 = V_{IL} , A9 = V_{ID} , Others V_{IL} or V_{IH}	0020h
Read Device Code	V_{IL}	V_{IL}	V_{IH}	A0 = V_{IH} , A1 = V_{IL} , A9 = V_{ID} , Others V_{IL} or V_{IH}	0097h

Note: 1. X = V_{IL} or V_{IH} .

COMMAND INTERFACE

All Bus Write operations to the memory are interpreted by the Command Interface. Commands consist of one or more sequential Bus Write operations. Failure to observe a valid sequence of Bus Write operations will result in the memory returning to Read mode. The long command sequences are imposed to maximize data security.

The commands are summarized in [Table 4., Commands](#). Refer to [Table 4.](#) in conjunction with the text descriptions below.

Read/Reset Command. The Read/Reset command returns the memory to its Read mode where it behaves like a ROM or EPROM. It also resets the errors in the Status Register. Either one or three Bus Write operations can be used to issue the Read/Reset command.

If the Read/Reset command is issued during a Block Erase operation or following a Programming or Erase error then the memory will take up to 10 μ s to abort. During the abort period no valid data can be read from the memory. Issuing a Read/Reset command during a Block Erase operation will leave invalid data in the memory.

Auto Select Command. The Auto Select command is used to read the Manufacturer Code, the Device Code and the Block Protection Status. Three consecutive Bus Write operations are required to issue the Auto Select command. Once the Auto Select command is issued the memory remains in Auto Select mode until another command is issued.

From the Auto Select mode the Manufacturer Code can be read using a Bus Read operation with A0 = V_{IL} and A1 = V_{IL}. The other address bits may be set to either V_{IL} or V_{IH}. The Manufacturer Code for STMicroelectronics is 0020h.

The Device Code can be read using a Bus Read operation with A0 = V_{IH} and A1 = V_{IL}. The other address bits may be set to either V_{IL} or V_{IH}. The Device Code for the M29F102BB is 0097h.

The Block Protection Status of each block can be read using a Bus Read operation with A0 = V_{IL}, A1 = V_{IH}, and A12-A15 specifying the address of the block. The other address bits may be set to either V_{IL} or V_{IH}. If the addressed block is protected then 01h is output on Data Inputs/Outputs DQ0-DQ7, otherwise 00h is output.

Program Command. The Program command can be used to program a value to one address in the memory array at a time. The command requires four Bus Write operations, the final write operation latches the address and data in the internal state machine and starts the Program/Erase Controller.

If the address falls in a protected block then the Program command is ignored, the data remains unchanged. The Status Register is never read and no error condition is given.

During the program operation the memory will ignore all commands. It is not possible to issue any command to abort or pause the operation. Typical program times are given in [Table 5.](#) Bus Read operations during the program operation will output the Status Register on the Data Inputs/Outputs. See the section on the Status Register for more details.

After the program operation has completed the memory will return to the Read mode, unless an error has occurred. When an error occurs the memory will continue to output the Status Register. A Read/Reset command must be issued to reset the error condition and return to Read mode.

Note that the Program command cannot change a bit set at '0' back to '1'. One of the Erase Commands must be used to set all the bits in a block or in the whole memory from '0' to '1'.

Unlock Bypass Command. The Unlock Bypass command is used in conjunction with the Unlock Bypass Program command to program the memory. When the access time to the device is long (as with some EPROM programmers) considerable time saving can be made by using these commands. Three Bus Write operations are required to issue the Unlock Bypass command.

Once the Unlock Bypass command has been issued the memory will only accept the Unlock Bypass Program command and the Unlock Bypass Reset command. The memory can be read as if in Read mode.

Unlock Bypass Program Command. The Unlock Bypass Program command can be used to program one address in memory at a time. The command requires two Bus Write operations, the final write operation latches the address and data in the internal state machine and starts the Program/Erase Controller.

The Program operation using the Unlock Bypass Program command behaves identically to the Program operation using the Program command. A protected block cannot be programmed; the operation cannot be aborted and the Status Register is read. Errors must be reset using the Read/Reset command, which leaves the device in Unlock Bypass Mode. See the Program command for details on the behavior.

Unlock Bypass Reset Command. The Unlock Bypass Reset command can be used to return to Read/Reset mode from Unlock Bypass Mode. Two Bus Write operations are required to issue the Unlock Bypass Reset command.

Chip Erase Command. The Chip Erase command can be used to erase the entire chip. Six Bus Write operations are required to issue the Chip Erase Command and start the Program/Erase Controller.

If any blocks are protected then these are ignored and all the other blocks are erased. If all of the blocks are protected the Chip Erase operation appears to start but will terminate within about 100 μ s, leaving the data unchanged. No error condition is given when protected blocks are ignored.

During the erase operation the memory will ignore all commands. It is not possible to issue any command to abort the operation. Typical chip erase times are given in Table 5.. All Bus Read operations during the Chip Erase operation will output the Status Register on the Data Inputs/Outputs. See the section on the Status Register for more details.

After the Chip Erase operation has completed the memory will return to the Read Mode, unless an error has occurred. When an error occurs the memory will continue to output the Status Register. A Read/Reset command must be issued to reset the error condition and return to Read Mode.

The Chip Erase Command sets all of the bits in unprotected blocks of the memory to '1'. All previous data is lost.

Block Erase Command. The Block Erase command can be used to erase a list of one or more blocks. Six Bus Write operations are required to select the first block in the list. Each additional block in the list can be selected by repeating the sixth Bus Write operation using the address of the additional block. The Block Erase operation starts the Program/Erase Controller about 50 μ s after the last Bus Write operation. Once the Program/Erase Controller starts it is not possible to select any more blocks. Each additional block must therefore be selected within 50 μ s of the last block. The 50 μ s timer restarts when an additional block is selected. The Status Register can be read after the sixth Bus Write operation. See the Status Register for details on how to identify if the Program/Erase Controller has started the Block Erase operation.

If any selected blocks are protected then these are ignored and all the other selected blocks are erased. If all of the selected blocks are protected the Block Erase operation appears to start but will terminate within about 100 μ s, leaving the data un-

changed. No error condition is given when protected blocks are ignored.

During the Block Erase operation the memory will ignore all commands except the Erase Suspend and Read/Reset commands. Typical block erase times are given in Table 5.. All Bus Read operations during the Block Erase operation will output the Status Register on the Data Inputs/Outputs. See the section on the Status Register for more details.

After the Block Erase operation has completed the memory will return to the Read Mode, unless an error has occurred. When an error occurs the memory will continue to output the Status Register. A Read/Reset command must be issued to reset the error condition and return to Read mode.

The Block Erase Command sets all of the bits in the unprotected selected blocks to '1'. All previous data in the selected blocks is lost.

Erase Suspend Command. The Erase Suspend Command may be used to temporarily suspend a Block Erase operation and return the memory to Read mode. The command requires one Bus Write operation.

The Program/Erase Controller will suspend within 15 μ s of the Erase Suspend Command being issued. Once the Program/Erase Controller has stopped the memory will be set to Read mode and the Erase will be suspended. If the Erase Suspend command is issued during the period when the memory is waiting for an additional block (before the Program/Erase Controller starts) then the Erase is suspended immediately and will start immediately when the Erase Resume Command is issued. It will not be possible to select any further blocks for erasure after the Erase Resume.

During Erase Suspend it is possible to Read and Program cells in blocks that are not being erased; both Read and Program operations behave as normal on these blocks. Reading from blocks that are being erased will output the Status Register. It is also possible to enter the Auto Select mode: the memory will behave as in the Auto Select mode on all blocks until a Read/Reset command returns the memory to Erase Suspend mode.

Erase Resume Command. The Erase Resume command must be used to restart the Program/Erase Controller from Erase Suspend. An erase can be suspended and resumed more than once.

Table 4. Commands

Command	Length	Bus Write Operations											
		1st		2nd		3rd		4th		5th		6th	
		Addr	Data	Addr	Data	Addr	Data	Addr	Data	Addr	Data	Addr	Data
Read/Reset	1	X	F0										
	3	555	AA	2AA	55	X	F0						
Auto Select	3	555	AA	2AA	55	555	90						
Program	4	555	AA	2AA	55	555	A0	PA	PD				
Unlock Bypass	3	555	AA	2AA	55	555	20						
Unlock Bypass Program	2	X	A0	PA	PD								
Unlock Bypass Reset	2	X	90	X	00								
Chip Erase	6	555	AA	2AA	55	555	80	555	AA	2AA	55	555	10
Block Erase	6+	555	AA	2AA	55	555	80	555	AA	2AA	55	BA	30
Erase Suspend	1	X	B0										
Erase Resume	1	X	30										

- Note: 1. X Don't Care, PA Program Address, PD Program Data, BA Any address in the Block.
2. All values in the table are in hexadecimal.
3. The Command Interface only uses address bits A0-A10 and DQ0-DQ7 to verify the commands, the upper address bits and the upper data bits are Don't Care.
4. Read/Reset.
5. After a Read/Reset command, read the memory as normal until another command is issued.
6. Auto Select.
7. After an Auto Select command, read Manufacturer ID, Device ID or Block Protection Status.
8. Program, Unlock Bypass Program, Chip Erase, Block Erase.
9. After these commands read the Status Register until the Program/Erase Controller completes and the memory returns to Read Mode. Add additional Blocks during Block Erase Command with additional Bus Write Operations until the Timeout Bit is set.
10. Unlock Bypass.
11. After the Unlock Bypass command issue Unlock Bypass Program or Unlock Bypass Reset commands.
12. Unlock Bypass Reset.
13. After the Unlock Bypass Reset command read the memory as normal until another command is issued.
14. Erase Suspend.
15. After the Erase Suspend command read non-erasing memory blocks as normal, issue Auto Select and Program commands on non-erasing blocks as normal.
16. Erase Resume.
17. After the Erase Resume command the suspended Erase operation resumes, read the Status Register until the Program/Erase Controller completes and the memory returns to Read Mode.

Table 5. Program, Erase Times and Program, Erase Endurance Cycles ($T_A = 0$ to 70°C)

Parameter	Min	Typ ⁽¹⁾	Typical after 100k W/E Cycles ⁽¹⁾	Max	Unit
Chip Erase (All bits in the memory set to '0')		0.6	0.6		s
Chip Erase		1.3	1.3	6	s
Block Erase (32 KWords)		0.6	0.6	4	s
Program		8	8	150	μs
Chip Program		0.6	0.6	2.5	s
Program/Erase Cycles (per Block)	100,000				cycles

Note: 1. $T_A = 25^\circ\text{C}$, $V_{CC} = 5\text{V}$.

STATUS REGISTER

Bus Read operations from any address always read the Status Register during Program and Erase operations. It is also read during Erase Suspend when an address within a block being erased is accessed.

The bits in the Status Register are summarized in [Table 6., Status Register Bits](#).

Data Polling Bit (DQ7). The Data Polling Bit can be used to identify whether the Program/Erase Controller has successfully completed its operation or if it has responded to an Erase Suspend. The Data Polling Bit is output on DQ7 when the Status Register is read.

During Program operations the Data Polling Bit outputs the complement of the bit being programmed to DQ7. After successful completion of the Program operation the memory returns to Read mode and Bus Read operations from the address just programmed output DQ7, not its complement.

During Erase operations the Data Polling Bit outputs '0', the complement of the erased state of DQ7. After successful completion of the Erase operation the memory returns to Read Mode.

In Erase Suspend mode the Data Polling Bit will output a '1' during a Bus Read operation within a block being erased. The Data Polling Bit will change from a '0' to a '1' when the Program/Erase Controller has suspended the Erase operation.

[Figure 5., Data Polling Flowchart](#), gives an example of how to use the Data Polling Bit. A Valid Address is the address being programmed or an address within the block being erased.

Toggle Bit (DQ6). The Toggle Bit can be used to identify whether the Program/Erase Controller has successfully completed its operation or if it has responded to an Erase Suspend. The Toggle Bit is output on DQ6 when the Status Register is read.

During Program and Erase operations the Toggle Bit changes from '0' to '1' to '0', etc., with successive Bus Read operations at any address. After successful completion of the operation the memory returns to Read mode.

During Erase Suspend mode the Toggle Bit will output when addressing a cell within a block being erased. The Toggle Bit will stop toggling when the Program/Erase Controller has suspended the Erase operation.

[Figure 6., Data Toggle Flowchart](#), gives an example of how to use the Data Toggle Bit.

Error Bit (DQ5). The Error Bit can be used to identify errors detected by the Program/Erase Controller. The Error Bit is set to '1' when a Program, Block Erase or Chip Erase operation fails to write the correct data to the memory. If the Error Bit is set a Read/Reset command must be issued before other commands are issued. The Error bit is output on DQ5 when the Status Register is read.

Note that the Program command cannot change a bit set at '0' back to '1' and attempting to do so may or may not set DQ5 at '1'. In both cases, a successive Bus Read operation will show the bit is still '0'. One of the Erase commands must be used to set all the bits in a block or in the whole memory from '0' to '1'.

Erase Timer Bit (DQ3). The Erase Timer Bit can be used to identify the start of Program/Erase Controller operation during a Block Erase command. Once the Program/Erase Controller starts erasing the Erase Timer Bit is set to '1'. Before the Program/Erase Controller starts the Erase Timer Bit is set to '0' and additional blocks to be erased may be written to the Command Interface. The Erase Timer Bit is output on DQ3 when the Status Register is read.

Alternative Toggle Bit (DQ2). The Alternative Toggle Bit can be used to monitor the Program/Erase controller during Erase operations. The Alternative Toggle Bit is output on DQ2 when the Status Register is read.

During Chip Erase and Block Erase operations the Toggle Bit changes from '0' to '1' to '0', etc., with successive Bus Read operations from addresses within the blocks being erased. Once the operation completes the memory returns to Read mode.

During Erase Suspend the Alternative Toggle Bit changes from '0' to '1' to '0', etc. with successive Bus Read operations from addresses within the blocks being erased. Bus Read operations to addresses within blocks not being erased will output the memory cell data as if in Read mode.

After an Erase operation that causes the Error Bit to be set the Alternative Toggle Bit can be used to identify which block or blocks have caused the error. The Alternative Toggle Bit changes from '0' to '1' to '0', etc. with successive Bus Read Operations from addresses within blocks that have not erased correctly. The Alternative Toggle Bit does not change if the addressed block has erased correctly.

Table 6. Status Register Bits

Operation	Address	DQ7	DQ6	DQ5	DQ3	DQ2
Program	Any Address	$\overline{DQ7}$	Toggle	0	–	–
Program During Erase Suspend	Any Address	$\overline{DQ7}$	Toggle	0	–	–
Program Error	Any Address	$\overline{DQ7}$	Toggle	1	–	–
Chip Erase	Any Address	0	Toggle	0	1	Toggle
Block Erase before timeout	Erasing Block	0	Toggle	0	0	Toggle
	Non-Erasing Block	0	Toggle	0	0	No Toggle
Block Erase	Erasing Block	0	Toggle	0	1	Toggle
	Non-Erasing Block	0	Toggle	0	1	No Toggle
Erase Suspend	Erasing Block	1	No Toggle	0	–	Toggle
	Non-Erasing Block	Data read as normal				
Erase Error	Good Block Address	0	Toggle	1	1	No Toggle
	Faulty Block Address	0	Toggle	1	1	Toggle

Note: 1. Unspecified data bits should be ignored.

Figure 5. Data Polling Flowchart

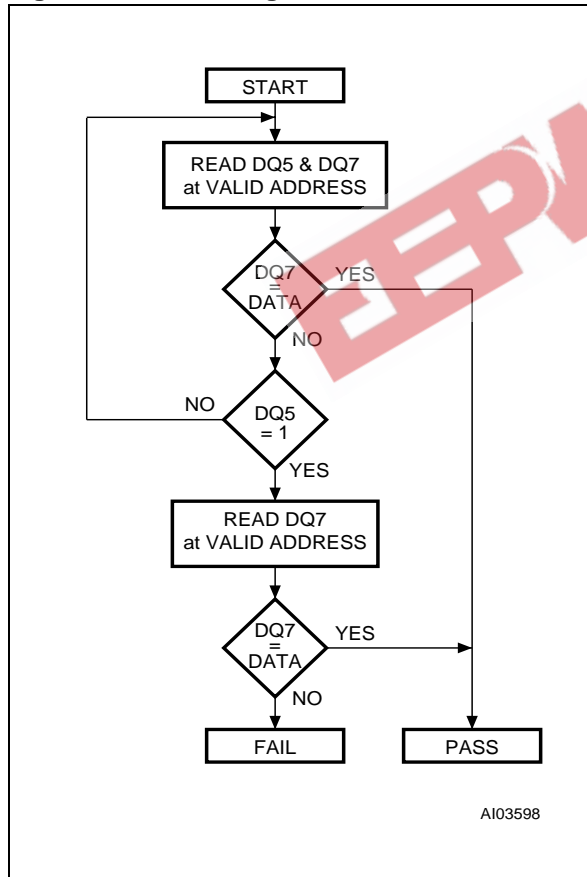
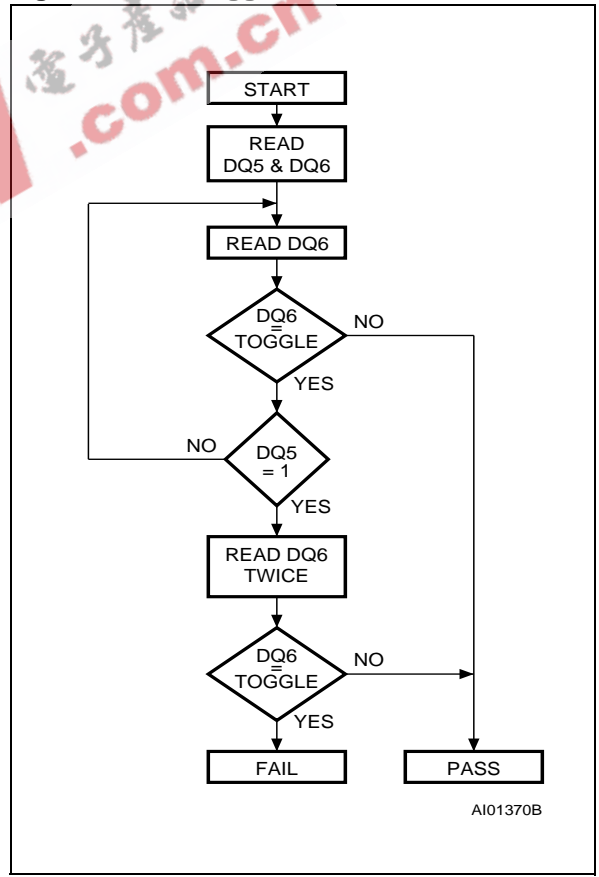

Figure 6. Data Toggle Flowchart



MAXIMUM RATINGS

Stressing the device above the rating listed in the Absolute Maximum Ratings table may cause permanent damage to the device. Exposure to Absolute Maximum Rating conditions for extended periods may affect device reliability. These are stress ratings only and operation of the device at

these or any other conditions above those indicated in the Operating sections of this specification is not implied. Refer also to the STMicroelectronics SURE Program and other relevant quality documents.

Table 7. Absolute Maximum Ratings ⁽¹⁾

Symbol	Parameter	Value	Unit
T _A	Ambient Operating Temperature	0 to 70	°C
T _{BIAS}	Temperature Under Bias	-50 to 125	°C
T _{STG}	Storage Temperature	-65 to 150	°C
T _{LEAD}	Lead Temperature during Soldering	(3)	
V _{IO} ⁽²⁾	Input or Output Voltage	-0.6 to 6	V
V _{CC}	Supply Voltage	-0.6 to 6	V
V _{ID}	Identification Voltage	-0.6 to 13.5	V

Note: 1. Except for the rating "Operating Temperature Range", stresses above those listed in [Table 7. Absolute Maximum Ratings \(1\)](#) may cause permanent damage to the device. These are stress ratings only and operation of the device at these or any other conditions above those indicated in the Operating sections of this specification is not implied. Exposure to Absolute Maximum Rating conditions for extended periods may affect device reliability. Refer also to the STMicroelectronics SURE Program and other relevant quality documents.

2. Minimum Voltage may undershoot to -2V during transition and for less than 20ns during transitions.

3. Compliant with the JEDEC Std J-STD-020B (for small body, Sn-Pb or Pb assembly), the ST ECOPACK® 7191395 specification, and the European directive on Restrictions on Hazardous Substances (RoHS) 2002/95/EU.

DC AND AC PARAMETERS

This section summarizes the operating measurement conditions, and the DC and AC characteristics of the device. The parameters in the DC and AC characteristics Tables that follow, are derived from tests performed under the Measurement

Conditions summarized in Table 9, Operating and AC Measurement Conditions. Designers should check that the operating conditions in their circuit match the operating conditions when relying on the quoted parameters.

Table 8. Operating and AC Measurement Conditions

Parameter	M29F102BB		Unit
	Min	Max	
Load Capacitance (C _L)	30		pF
Input Rise and Fall Times		10	ns
Input Pulse Voltages	0	3	V
Input and Output Timing Ref. Voltages	1.5		V

Figure 7. AC Testing Input Output Waveform

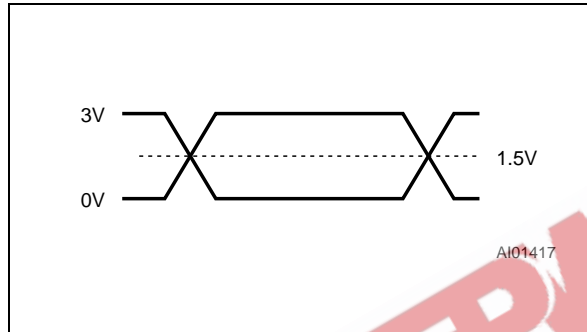

Figure 8. AC Testing Load Circuit

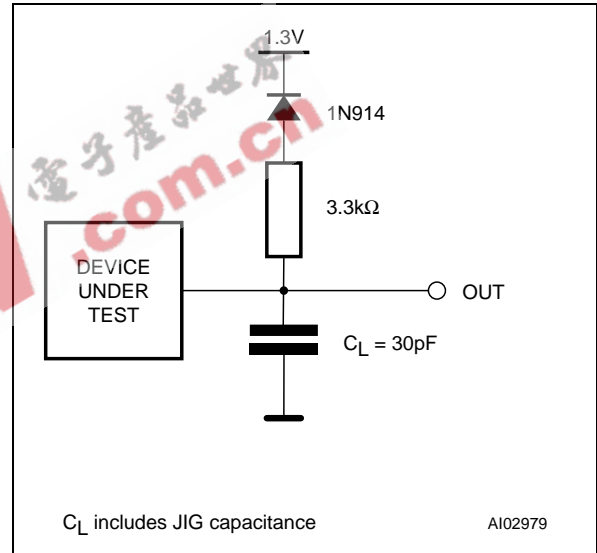

Table 9. Capacitance (T_A = 25 °C, f = 1 MHz)

Symbol	Parameter	Test Condition	Min	Max	Unit
C _{IN}	Input Capacitance	V _{IN} = 0V		6	pF
C _{OUT}	Output Capacitance	V _{OUT} = 0V		12	pF

Note: Sampled only, not 100% tested.

Table 10. DC Characteristics ($T_A = 0$ to 70°C)

Symbol	Parameter	Test Condition	Min	Typ ⁽³⁾	Max	Unit
$I_{LI}^{(1)}$	Input Leakage Current	$0V \leq V_{IN} \leq V_{CC}$			± 1	μA
I_{LR1}	\overline{RP} Leakage Current High	$\overline{RP} = V_{CC}$			± 1	μA
I_{LR2}	\overline{RP} Leakage Current Low	$\overline{RP} = V_{SS}$	-0.2		-10	μA
I_{LO}	Output Leakage Current	$0V \leq V_{OUT} \leq V_{CC}$			± 1	μA
I_{CC1}	Supply Current (Read)	$\overline{E} = V_{IL}, \overline{G} = V_{IH}, f = 6\text{MHz}$		6	20	mA
I_{CC2}	Supply Current (Standby)	$\overline{E} = V_{CC} \pm 0.2V,$ $\overline{RP} = V_{CC} \pm 0.2V$		30	100	μA
$I_{CC3}^{(2)}$	Supply Current (Program/ Erase)	Program/Erase Controller active			20	mA
V_{IL}	Input Low Voltage		-0.5		0.8	V
V_{IH}	Input High Voltage		2		$V_{CC} + 0.5$	V
V_{OL}	Output Low Voltage	$I_{OL} = 5.8\text{mA}$			0.45	V
V_{OH}	Output High Voltage	$I_{OH} = -100\mu\text{A}$	$V_{CC} - 0.4$			V
V_{ID}	Identification Voltage		11.5		12.5	V
I_{ID}	Identification Current	$A9 = V_{ID}$			100	μA
$V_{LKO}^{(2)}$	Program/Erase Lockout Supply Voltage		3.2		4.2	V

Note: 1. Excluding the \overline{RP} input.
 2. Sampled only, not 100% tested.
 3. $T_A = 25^\circ\text{C}$, $V_{CC} = 5V$

Table 11. Read AC Characteristics (TA = 0 to 70°C)

Symbol	Alt	Parameter	Test Condition		M29F102BB				Unit
					35	45	50 / 55	70	
t _{AVAV} ⁽¹⁾	t _{RC}	Address Valid to Next Address Valid	$\bar{E} = V_{IL}, \bar{G} = V_{IL}$	Min	35	45	50	70	ns
t _{AVQV} ⁽¹⁾	t _{ACC}	Address Valid to Output Valid	$\bar{E} = V_{IL}, \bar{G} = V_{IL}$	Max	35	45	50	70	ns
t _{ELQX} ⁽²⁾	t _{LZ}	Chip Enable Low to Output Transition	$\bar{G} = V_{IL}$	Min	0	0	0	0	ns
t _{ELQV} ⁽¹⁾	t _{CE}	Chip Enable Low to Output Valid	$\bar{G} = V_{IL}$	Max	35	45	50	70	ns
t _{GLQX} ⁽²⁾	t _{OLZ}	Output Enable Low to Output Transition	$\bar{E} = V_{IL}$	Min	0	0	0	0	ns
t _{GLQV} ⁽¹⁾	t _{OE}	Output Enable Low to Output Valid	$\bar{E} = V_{IL}$	Max	20	20	20	30	ns
t _{EHQZ} ⁽²⁾	t _{HZ}	Chip Enable High to Output Hi-Z	$\bar{G} = V_{IL}$	Max	15	15	18	20	ns
t _{GHQZ} ⁽²⁾	t _{DF}	Output Enable High to Output Hi-Z	$\bar{E} = V_{IL}$	Max	15	15	18	20	ns
t _{EHQX} t _{GHQX} t _{AXQX}	t _{OH}	Chip Enable, Output Enable or Address Transition to Output Transition		Min	0	0	0	0	ns

Note: 1. This timing refers to a Load Capacitance (C_L) of 30pF. If C_L is higher, add 1.5ns for each extra 10pF.
 2. Sampled only, not 100% tested.

Figure 9. Read Mode AC Waveforms

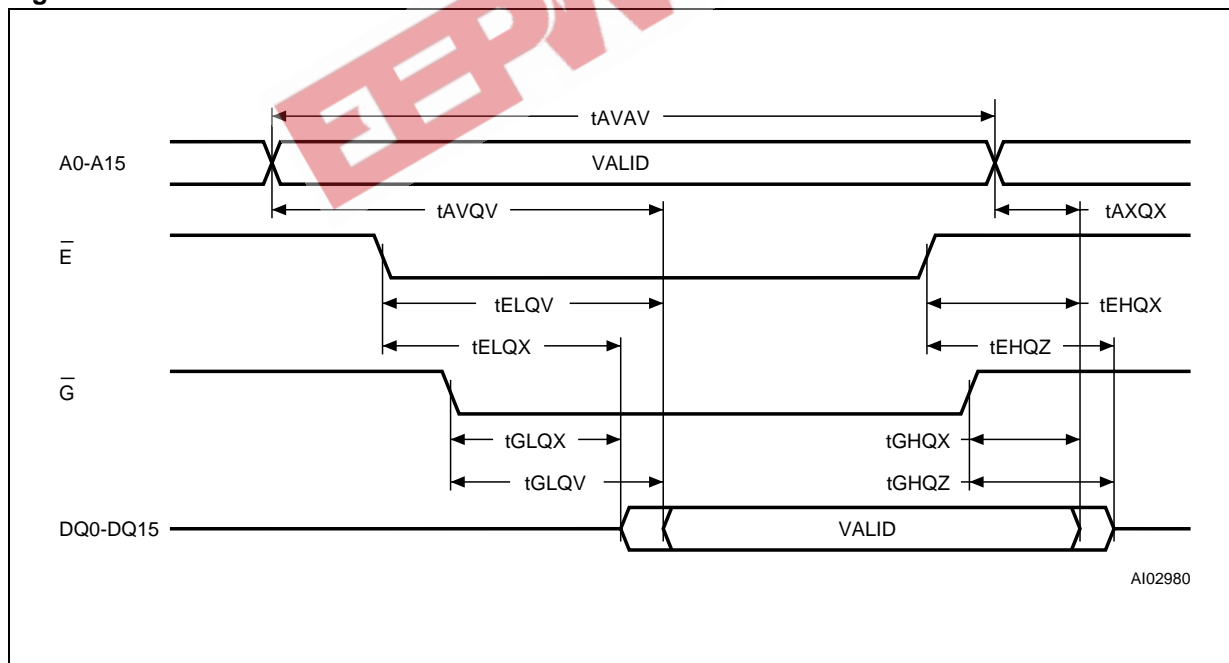

Table 12. Write AC Characteristics, Write Enable Controlled ($T_A = 0$ to 70 °C)

Symbol	Alt	Parameter		M29F102BB				Unit
				35	45	50 / 55	70	
t_{AVAV}	t_{WC}	Address Valid to Next Address Valid	Min	35	45	50	70	ns
t_{ELWL}	t_{CS}	Chip Enable Low to Write Enable Low	Min	0	0	0	0	ns
t_{WLWH}	t_{WP}	Write Enable Low to Write Enable High	Min	35	40	40	45	ns
t_{DVWH}	t_{DS}	Input Valid to Write Enable High	Min	20	25	25	30	ns
t_{WHDX}	t_{DH}	Write Enable High to Input Transition	Min	0	0	0	0	ns
t_{WHEH}	t_{CH}	Write Enable High to Chip Enable High	Min	0	0	0	0	ns
t_{WHWL}	t_{WPH}	Write Enable High to Write Enable Low	Min	20	20	20	20	ns
t_{AVWL}	t_{AS}	Address Valid to Write Enable Low	Min	0	0	0	0	ns
t_{WLAX}	t_{AH}	Write Enable Low to Address Transition	Min	35	40	40	45	ns
t_{GHWL}		Output Enable High to Write Enable Low	Min	0	0	0	0	ns
t_{WHGL}	t_{OEHL}	Write Enable High to Output Enable Low	Min	0	0	0	0	ns
t_{VCHEL}	t_{VCS}	V_{CC} High to Chip Enable Low	Min	50	50	50	50	μ s

Figure 10. Write AC Waveforms, Write Enable Controlled

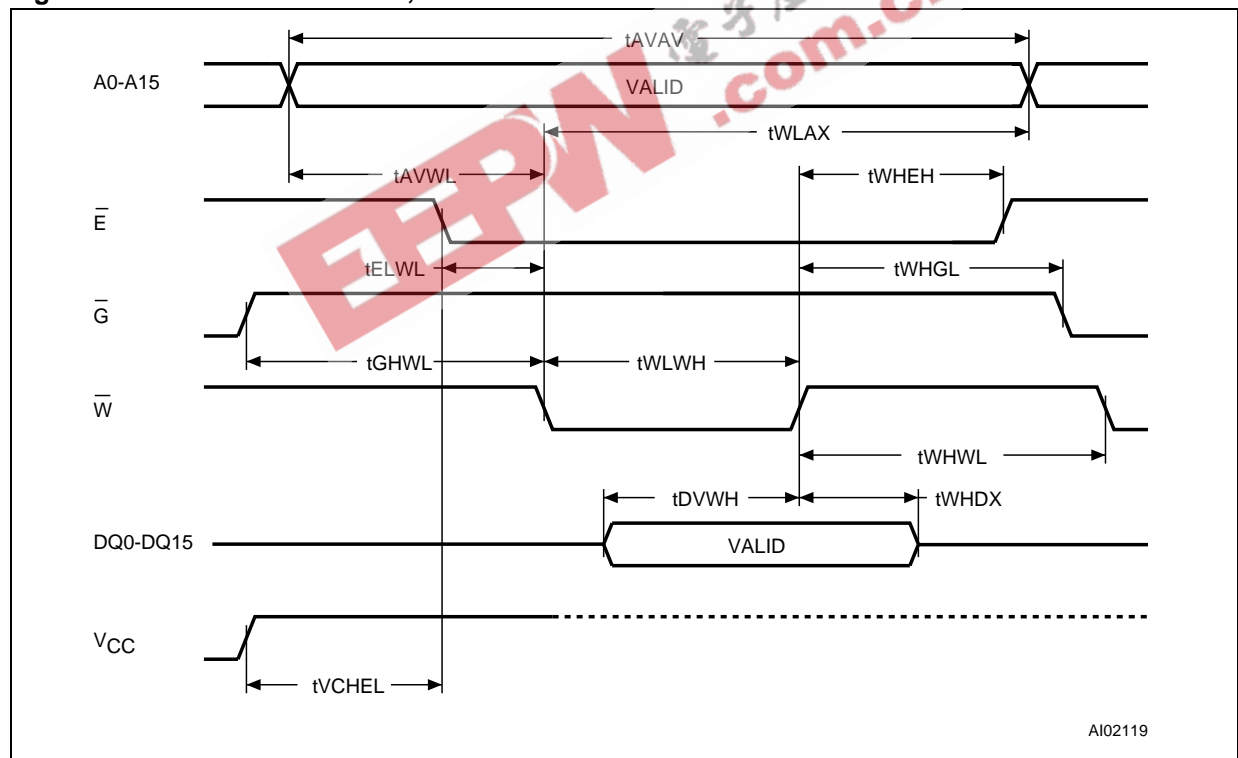

Table 13. Write AC Characteristics, Chip Enable Controlled ($T_A = 0$ to 70 °C)

Symbol	Alt	Parameter		M29F102BB				Unit
				35	45	50 / 55	70	
t_{AVAV}	t_{WC}	Address Valid to Next Address Valid	Min	35	45	50	70	ns
t_{WLEL}	t_{WS}	Write Enable Low to Chip Enable Low	Min	0	0	0	0	ns
t_{ELEH}	t_{CP}	Chip Enable Low to Chip Enable High	Min	35	40	40	45	ns
t_{DVEH}	t_{DS}	Input Valid to Chip Enable High	Min	20	25	25	30	ns
t_{EHDX}	t_{DH}	Chip Enable High to Input Transition	Min	0	0	0	0	ns
t_{EHWH}	t_{WH}	Chip Enable High to Write Enable High	Min	0	0	0	0	ns
t_{EHEL}	t_{CPH}	Chip Enable High to Chip Enable Low	Min	20	20	20	20	ns
t_{AVEL}	t_{AS}	Address Valid to Chip Enable Low	Min	0	0	0	0	ns
t_{ELAX}	t_{AH}	Chip Enable Low to Address Transition	Min	35	40	40	45	ns
t_{GHEL}		Output Enable High Chip Enable Low	Min	0	0	0	0	ns
t_{EHGL}	t_{OEHL}	Chip Enable High to Output Enable Low	Min	0	0	0	0	ns
t_{VCHWL}	t_{VCS}	V_{CC} High to Write Enable Low	Min	50	50	50	50	μ s

Figure 11. Write AC Waveforms, Chip Enable Controlled

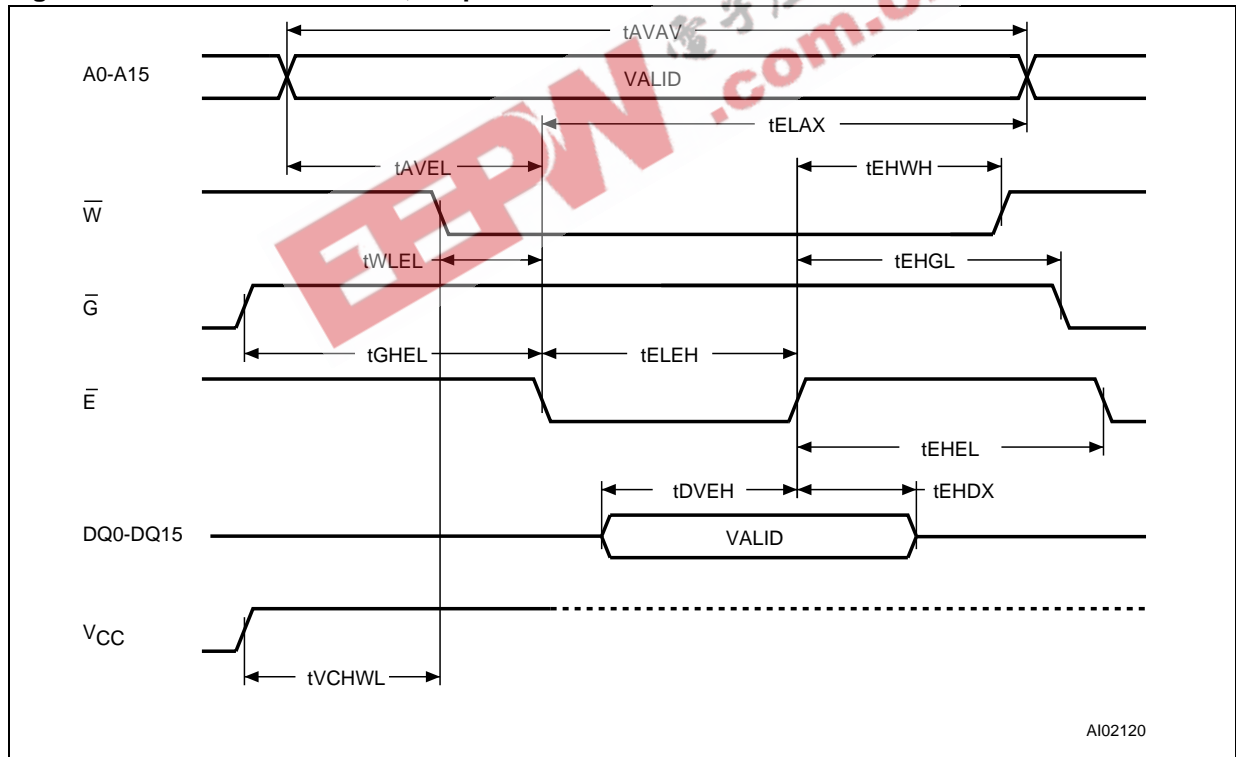
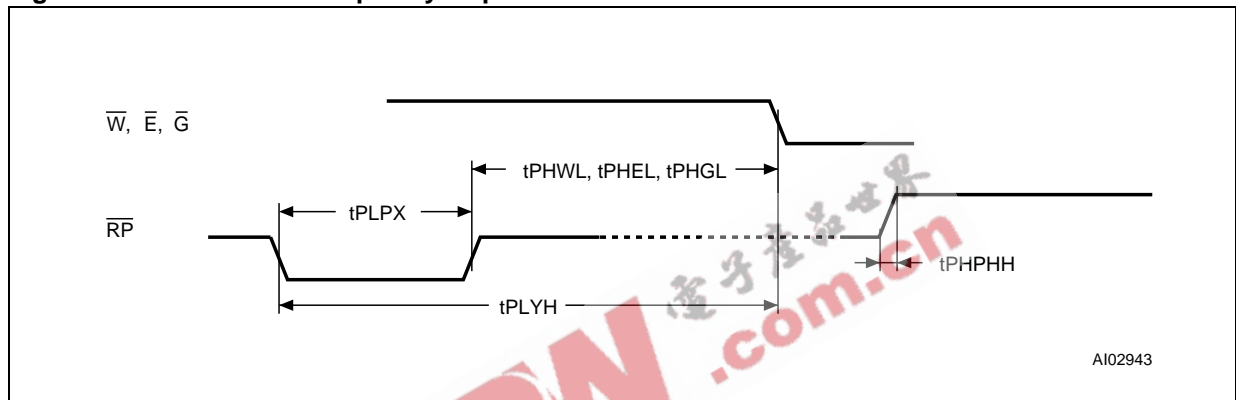

Table 14. Reset/Block Temporary Unprotect AC Characteristics ($T_A = 0$ to 70°C)

Symbol	Alt	Parameter	M29F102BB			Unit	
			50	70	90		
$t_{PHWL}^{(1)}$ $t_{PHEL}^{(1)}$ $t_{PHGL}^{(1)}$	t_{RH}	\overline{RP} High to Write Enable Low, Chip Enable Low, Output Enable Low	Min	50	50	50	ns
t_{PLPX}	t_{RP}	\overline{RP} Pulse Width	Min	500	500	500	ns
$t_{PLYH}^{(1)}$	t_{READY}	\overline{RP} Low to Read Mode	Max	10	10	10	μs
$t_{PHPHH}^{(1)}$	t_{VIDR}	\overline{RP} Rise Time to V_{ID}	Min	500	500	500	ns

Note: 1. Sampled only, not 100% tested.

Figure 12. Reset/Block Temporary Unprotect AC Waveforms



PACKAGE MECHANICAL

Figure 13. PLCC44 - 44 lead Plastic Leaded Chip Carrier, Package Outline

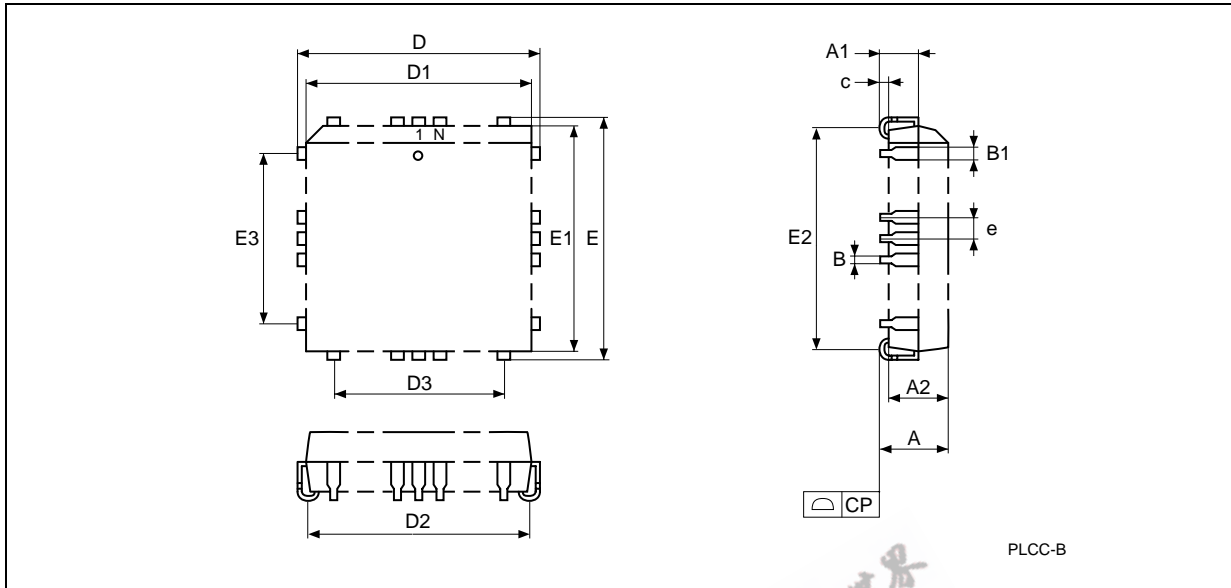

Note: Drawing is not to scale.

Table 15. PLCC44 - 44 lead Plastic Leaded Chip Carrier, Package Mechanical Data

Symbol	millimeters			inches		
	Typ	Min	Max	Typ	Min	Max
A		4.200	4.570		0.1654	0.1799
A1		2.290	3.040		0.0902	0.1197
A2		3.650	3.700		0.1437	0.1457
B		0.331	0.533		0.0130	0.0210
B1		0.661	0.812		0.0260	0.0320
CP			0.101			0.0040
c	0.510			0.0201		
D		17.400	17.650		0.6850	0.6949
D1		16.510	16.662		0.6500	0.6560
D2		14.990	16.000		0.5902	0.6299
D3	12.700	-	-	0.5000	-	-
E		17.400	17.650		0.6850	0.6949
E1		16.510	16.660		0.6500	0.6559
E2		14.990	16.000		0.5902	0.6299
E3	12.700	-	-	0.5000	-	-
e	1.270	-	-	0.0500	-	-
N	44			44		

Figure 14. TSOP40 - 40 lead Plastic Thin Small Outline, 10 x 14mm, Package Outline

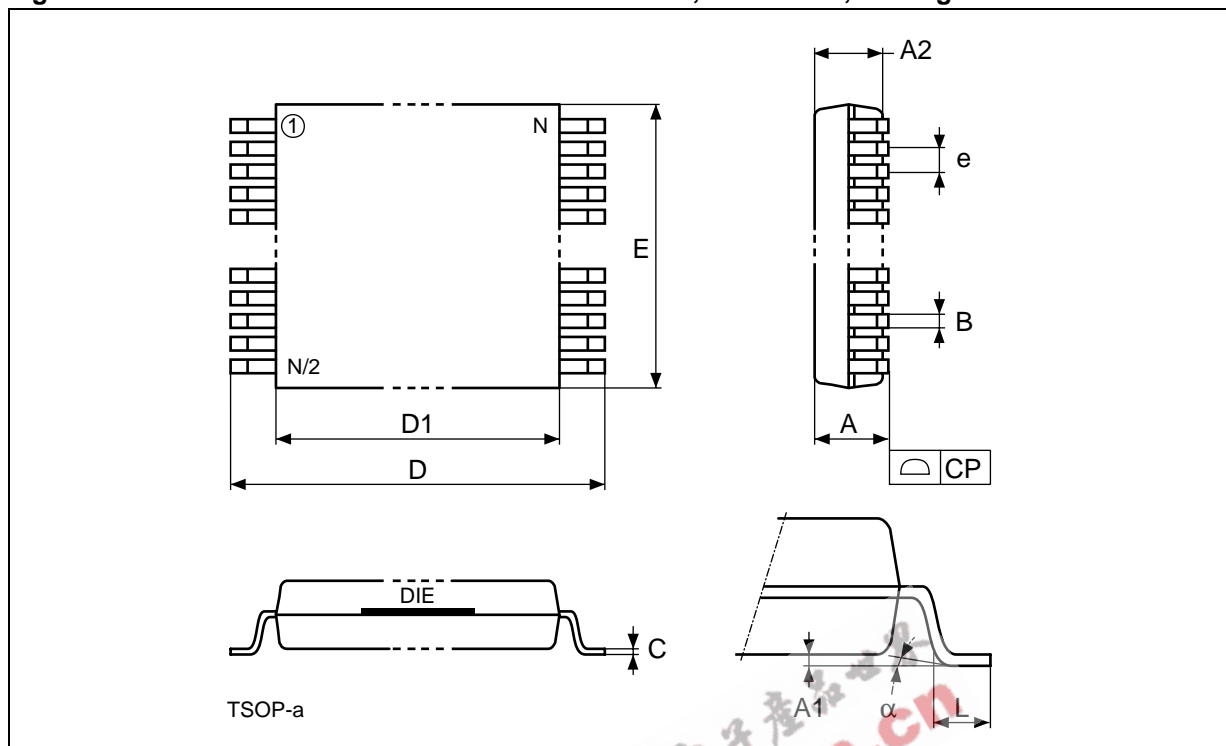

Note: Drawing is not to scale.

Table 16. PTSOP40 - 40 lead Plastic Thin Small Outline, 10 x 14mm, Package Mechanical Data

Symbol	millimeters			inches		
	Typ	Min	Max	Typ	Min	Max
A			1.20			0.0472
A1		0.05	0.15		0.0020	0.0059
A2		0.95	1.05		0.0374	0.0413
B		0.17	0.27		0.0067	0.0106
C		0.10	0.21		0.0039	0.0083
D		13.80	14.20		0.5433	0.5591
D1		12.30	12.50		0.4843	0.4921
E		9.90	10.10		0.3898	0.3976
e	0.50	–	–	0.0197	–	–
L		0.50	0.70		0.0197	0.0276
α		0°	5°		0°	5°
N	40			40		
CP			0.10			0.0039

ORDERING INFORMATION SCHEME

Table 17. Ordering Information Scheme

Example:	M29F102BB	50	N	1	T
Device Type M29					
Operating Voltage F = V _{CC} = 5V ± 10%					
Device Function 102BB = 1 Mbit (64Kb x16), Bottom Boot Block					
Speed 35 = 35ns 45 = 45 ns 50 = 50 ns 55 = 55 ns 70 = 70 ns					
Package K = PLCC44 N = TSOP40:10 x 14mm					
Temperature Range 1 = 0 to 70 °C					
Option T = Tape & Reel Packing F = Lead-free and RoHS Package, Tape & Reel Packing					

Note: The last two characters of the ordering code may be replaced by a letter code for preprogrammed parts, otherwise devices are shipped from the factory with the memory content bits erased to '1'.
For a list of available options (Speed, Package, etc...) or for further information on any aspect of this device, please contact the ST Sales Office nearest to you.

REVISION HISTORY

Table 18. Revision History

Date	Version	Revision Details
July 1999	1.0	First Issue
28-Jul-00	2.0	New document template Status Register bit DQ5 clarification Data Polling Flowchart diagram change (Figure 5.) Data Toggle Flowchart diagram change (Figure 6.)
30-Nov-2004	3.0	Document restructured. PLCC44 and TSOP40 Lead-free options added: SUMMARY DESCRIPTION , SIGNAL DESCRIPTIONS updated with Lead-free packages, T_{LEAD} parameter added in Table 7. , Absolute Maximum Ratings (1) and Lead-free option added in Table 17. , Ordering Information Scheme .

EEPW 电子產品世界
.com.cn

EEPW 电子产品世界
.com.cn

Information furnished is believed to be accurate and reliable. However, STMicroelectronics assumes no responsibility for the consequences of use of such information nor for any infringement of patents or other rights of third parties which may result from its use. No license is granted by implication or otherwise under any patent or patent rights of STMicroelectronics. Specifications mentioned in this publication are subject to change without notice. This publication supersedes and replaces all information previously supplied. STMicroelectronics products are not authorized for use as critical components in life support devices or systems without express written approval of STMicroelectronics.

The ST logo is a registered trademark of STMicroelectronics.
ECOPACK is a registered trademark of STMicroelectronics.
All other names are the property of their respective owners

© 2004 STMicroelectronics - All rights reserved

STMicroelectronics group of companies
Australia - Belgium - Brazil - Canada - China - Czech Republic - Finland - France - Germany - Hong Kong - India - Israel - Italy - Japan -
Malaysia - Malta - Morocco - Singapore - Spain - Sweden - Switzerland - United Kingdom - United States of America
www.st.com