

LM4899 Boomer® Audio Power Amplifier Series

1 Watt Fully Differential Audio Power Amplifier With Shutdown Select and Fixed 6dB Gain

General Description

The LM4899 is a fully differential audio power amplifier primarily designed for demanding applications in mobile phones and other portable communication device applications. It is capable of delivering 1 watt of continuous average power to an 8Ω load with less than 1% distortion (THD+N) from a 5V_{DC} power supply.

Boomer audio power amplifiers were designed specifically to provide high quality output power with a minimal amount of external components. The LM4899 does not require output coupling capacitors or bootstrap capacitors, and therefore is ideally suited for mobile phone and other low voltage applications where minimal power consumption is a primary requirement.

The LM4899 features a low-power consumption shutdown mode. To facilitate this, Shutdown may be enabled by either logic high or low depending on mode selection. Driving the shutdown mode pin either high or low enables the shutdown select pin to be driven in a likewise manner to enable Shutdown. Additionally, the LM4899 features an internal thermal shutdown protection mechanism.

The LM4899 contains advanced pop & click circuitry which virtually eliminates noises which would otherwise occur during turn-on and turn-off transitions.

The LM4899 has an internally fixed gain of 6dB.

Key Specifications

■ Improved PSRR at 217Hz	83dB
■ Power Output at 5.0V & 1% THD	1.0W(typ.)
■ Power Output at 3.3V & 1% THD	400mW(typ.)
■ Shutdown Current	0.1μA(typ.)

Features

- Fully differential amplification
- Internal-gain-setting resistors
- Available in space-saving packages micro SMD, MSOP and LLP
- Ultra low current shutdown mode
- Can drive capacitive loads up to 500pF
- Improved pop & click circuitry which virtually eliminates noises during turn-on and turn-off transitions
- 2.4 - 5.5V operation
- No output coupling capacitors, snubber networks or bootstrap capacitors required
- Shutdown high or low selectivity

Applications

- Mobile phones
- PDAs
- Portable electronic devices

Connection Diagrams

9 Bump micro SMD Package

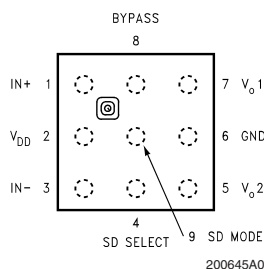

Top View

Order Number LM4899ITL, LM4899ITLX
See NS Package Number TLA09AAA

9 Bump micro SMD Marking

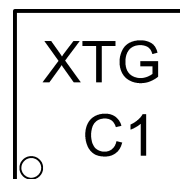

200645C7

X - Date Code
T - Die Run Traceability
G - Boomer Family
C1 - LM4899ITL

Connection Diagrams (Continued)

Mini Small Outline (MSOP) Package

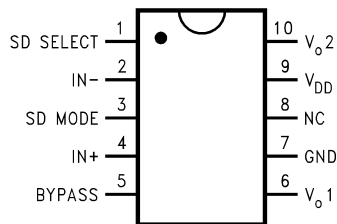

20064523

Top View
Order Number LM4899MM
See NS Package Number MUB10A

MSOP Marking



200645C9

Z - Assembly Code
X - Date Code
TT - Die Run Traceability
G - Boomer Family
B1 - LM4899MM

LD Package

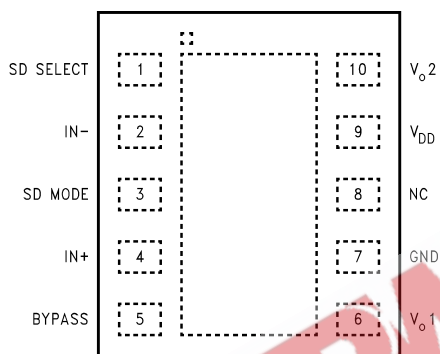

20064535

Top View
Order Number LM4899LD
See NS Package Number LDA10B

LD Marking



200645C8

Z - Assembly Code
XY - Date Code
TT - Die Run Traceability
L4899 - LM4899LD

Typical Application

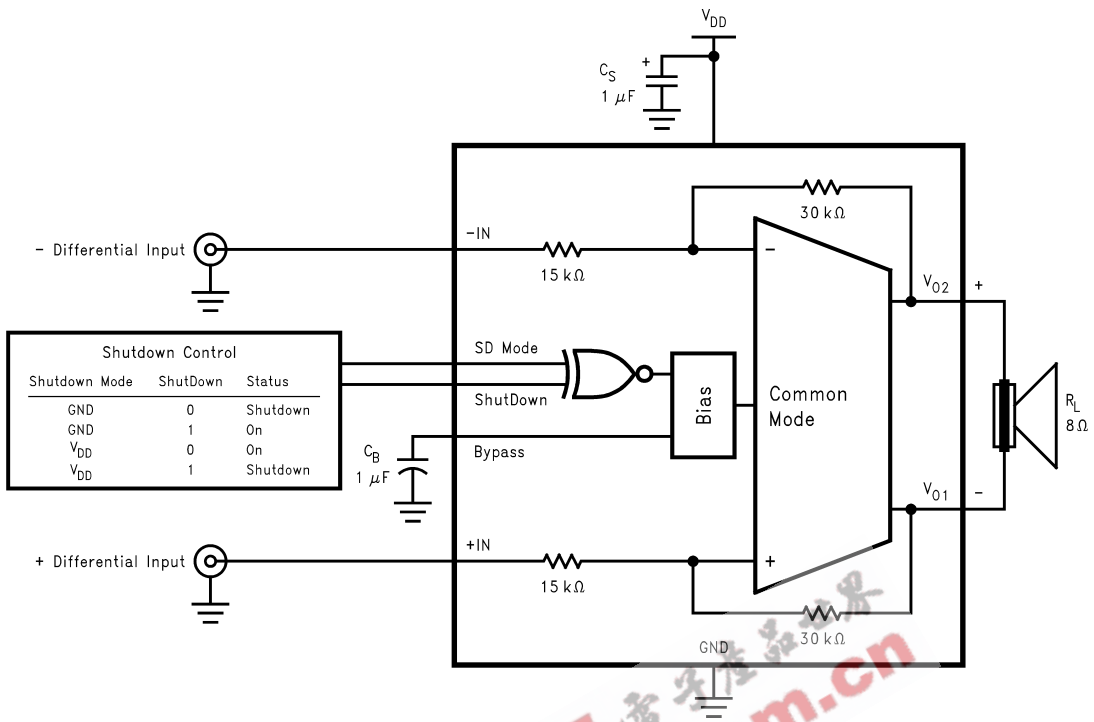

200645D0

FIGURE 1. Typical Audio Amplifier Application Circuit

Absolute Maximum Ratings (Note 2)

If Military/Aerospace specified devices are required, please contact the National Semiconductor Sales Office/Distributors for availability and specifications.

Supply Voltage	6.0V
Storage Temperature	-65°C to +150°C
Input Voltage	-0.3V to $V_{DD} + 0.3V$
Power Dissipation (Note 3)	Internally Limited
ESD Susceptibility (Note 4)	2000V
ESD Susceptibility (Note 5)	200V
Junction Temperature	150°C
Thermal Resistance	
θ_{JC} (LD)	12°C/W
θ_{JA} (LD)	63°C/W

θ_{JA} (micro SMD)	220°C/W
θ_{JC} (MSOP)	56°C/W
θ_{JA} (MSOP)	190°C/W

Soldering Information

See AN-1112 "microSMD Wafers Level Chip Scale Package".

Operating Ratings

Temperature Range

$$T_{MIN} \leq T_A \leq T_{MAX} \quad -40^\circ\text{C} \leq T_A \leq +85^\circ\text{C}$$

Supply Voltage

$$2.4V \leq V_{DD} \leq 5.5V$$

Electrical Characteristics $V_{DD} = 5V$ (Notes 1, 2, 8)

The following specifications apply for $V_{DD} = 5V$ and 8Ω load unless otherwise specified. Limits apply for $T_A = 25^\circ\text{C}$.

Symbol	Parameter	Conditions	LM4899		Units (Limits)
			Typical (Note 6)	Limit (Note 7)	
I_{DD}	Quiescent Power Supply Current	$V_{IN} = 0V$, no Load	3	6	mA (max)
		$V_{IN} = 0V$, $R_L = 8\Omega$	5	10	
I_{SD}	Standby Current	$V_{SDMODE} = V_{SHUTDOWN} = GND$	0.1	1	μA (max)
P_o	Output Power	THD = 1% (max); $f = 1\text{ kHz}$			W (min)
		LM4899LD, $R_L = 4\Omega$ (Note 11)	1.4		
		LM4899, $R_L = 8\Omega$	1	0.9	
THD+N	Total Harmonic Distortion+Noise	$P_o = 0.4\text{ Wrms}$; $f = 1\text{ kHz}$	0.05		%
PSRR	Power Supply Rejection Ratio	$V_{ripple} = 200\text{mV}$ sine p-p			dB (min)
		$f = 217\text{Hz}$ (Note 9)	83		
		$f = 1\text{kHz}$ (Note 9)	90		
		$f = 217\text{Hz}$ (Note 10)	83	71	
		$f = 1\text{kHz}$ (Note 10)	83	71	
CMRR	Common-Mode Rejection Ratio	$f = 217\text{Hz}$, $V_{CM} = 200\text{mV}_{pp}$	50		dB
V_{OS}	Output Offset	$V_{IN} = 0V$	2		mV
V_{SDIH}	Shutdown Voltage Input High	SD Mode = GND	0.9		V
V_{SDIL}	Shutdown Voltage Input Low	SD Mode = GND	0.7		V
V_{SDIH}	Shutdown Voltage Input High	SD Mode = V_{DD}	0.9		V
V_{SDIL}	Shutdown Voltage Input Low	SD Mode = V_{DD}	0.7		V

Electrical Characteristics $V_{DD} = 3V$ (Notes 1, 2, 8)

The following specifications apply for $V_{DD} = 3V$ and 8Ω load unless otherwise specified. Limits apply for $T_A = 25^\circ\text{C}$.

Symbol	Parameter	Conditions	LM4899		Units (Limits)
			Typical (Note 6)	Limit (Note 7)	
I_{DD}	Quiescent Power Supply Current	$V_{IN} = 0V$, no Load	2.5	5.5	mA (max)
		$V_{IN} = 0V$, $R_L = 8\Omega$	4	9	
I_{SD}	Standby Current	$V_{SDMODE} = V_{SHUTDOWN} = GND$	0.1	1	μA (max)
P_o	Output Power	THD = 1% (max); $f = 1\text{ kHz}$			W
		LM4899, $R_L = 8\Omega$	0.35		
THD+N	Total Harmonic Distortion+Noise	$P_o = 0.25\text{ Wrms}$; $f = 1\text{ kHz}$	0.3		%

Electrical Characteristics $V_{DD} = 3V$ (Notes 1, 2, 8)

The following specifications apply for $V_{DD} = 3V$ and 8Ω load unless otherwise specified. Limits apply for $T_A = 25^\circ C$. (Continued)

Symbol	Parameter	Conditions	LM4899		Units (Limits)
			Typical	Limit	
			(Note 6)	(Note 7)	
PSRR	Power Supply Rejection Ratio	$V_{ripple} = 200mV$ sine p-p			dB
		$f = 217Hz$ (Note 9)	83		
		$f = 1kHz$ (Note 9)	84		
		$f = 217Hz$ (Note 10)	83		
		$f = 1kHz$ (Note 10)	83		
CMRR	Common-Mode Rejection Ratio	$f = 217Hz, V_{CM} = 200mV_{pp}$	50		dB
V_{OS}	Offset Voltage	$V_{IN} = 0V$	2		mV
V_{SDIH}	Shutdown Voltage Input High	SD Mode = GND	0.8		V
V_{SDIL}	Shutdown Voltage Input Low	SD Mode = GND	0.6		V
V_{SDIH}	Shutdown Voltage Input High	SD Mode = V_{DD}	0.8		V
V_{SDIL}	Shutdown Voltage Input Low	SD Mode = V_{DD}	0.6		V

Note 1: All voltages are measured with respect to the ground pin, unless otherwise specified.

Note 2: *Absolute Maximum Ratings* indicate limits beyond which damage to the device may occur. *Operating Ratings* indicate conditions for which the device is functional, but do not guarantee specific performance limits. *Electrical Characteristics* state DC and AC electrical specifications under particular test conditions which guarantee specific performance limits. This assumes that the device is within the Operating Ratings. Specifications are not guaranteed for parameters where no limit is given, however, the typical value is a good indication of device performance.

Note 3: The maximum power dissipation must be derated at elevated temperatures and is dictated by T_{JMAX} , θ_{JA} , and the ambient temperature T_A . The maximum allowable power dissipation is $P_{DMAX} = (T_{JMAX} - T_A) / \theta_{JA}$ or the number given in Absolute Maximum Ratings, whichever is lower. For the LM4899, see power derating currents for additional information.

Note 4: Human body model, 100pF discharged through a 1.5k Ω resistor.

Note 5: Machine Model, 220pF–240pF discharged through all pins.

Note 6: Typical values are measured at 25°C and represent the parametric norm.

Note 7: Datasheet min/max specification limits are guaranteed by design, test, or statistical analysis.

Note 8: For micro SMD only, shutdown current is measured in a Normal Room Environment. Exposure to direct sunlight will increase I_{SD} by a maximum of 2 μA .

Note 9: Unterminated input.

Note 10: 10 Ω terminated input.

Note 11: : When driving 4 Ω loads from a 5V power supply, the LM4899LD must be mounted to a circuit board with the exposed-DAP area soldered down to a 1sq. in plane of 1oz. copper.

External Components Description (Figure 1)

Components		Functional Description
1.	C_S	Supply bypass capacitor which provides power supply filtering. Refer to the Power Supply Bypassing section for information concerning proper placement and selection of the supply bypass capacitor.
2.	C_B	Bypass pin capacitor which provides half-supply filtering. Refer to the section, Proper Selection of External Components , for information concerning proper placement and selection of C_B .

Typical Performance Characteristics LD Specific Characteristics

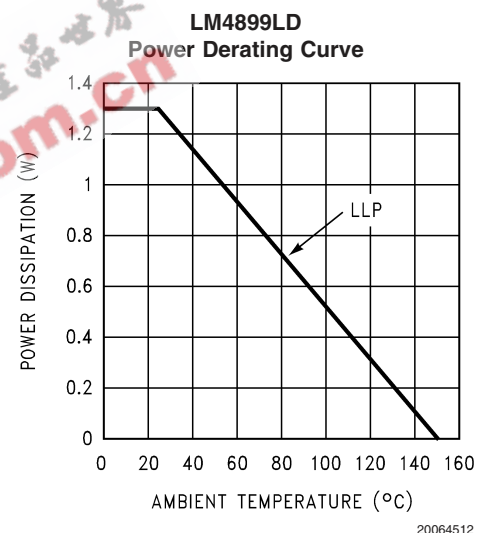
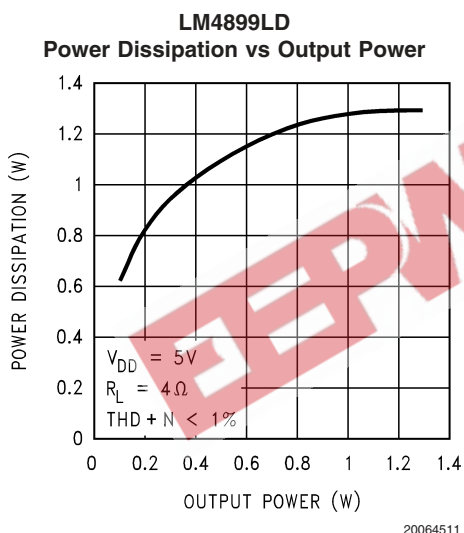
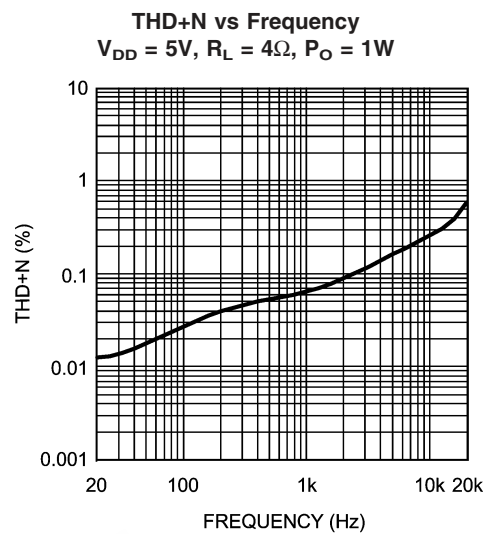
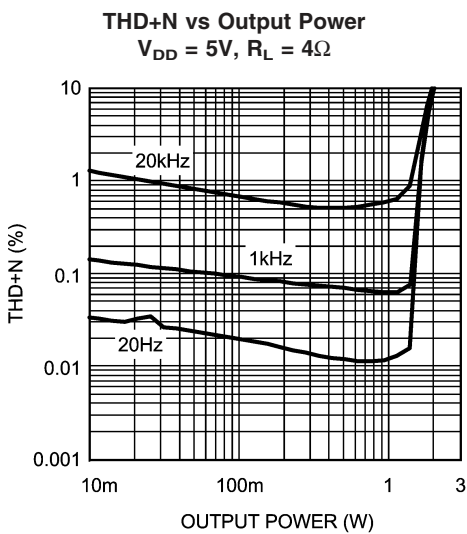

Typical Performance Characteristics Non-LD Specific Characteristics

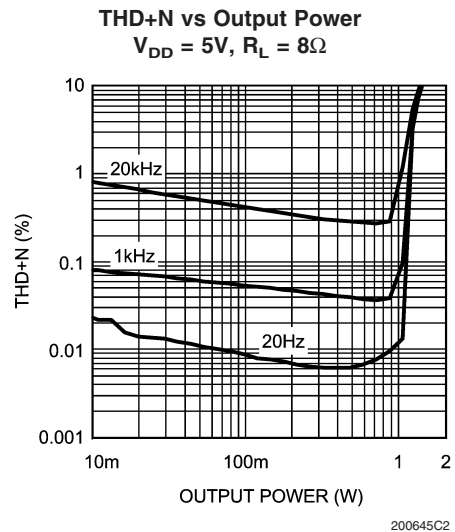
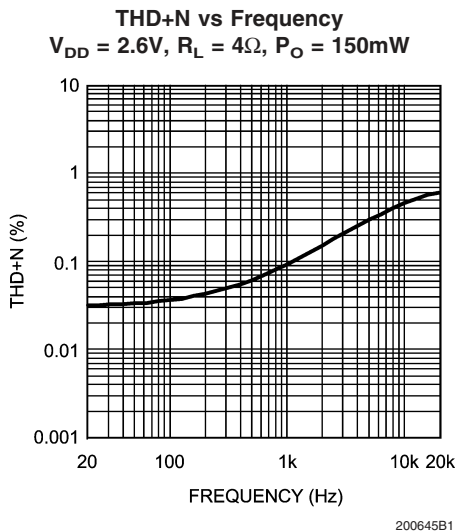
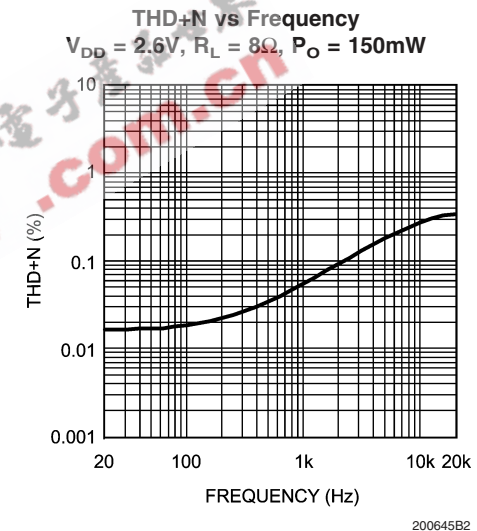
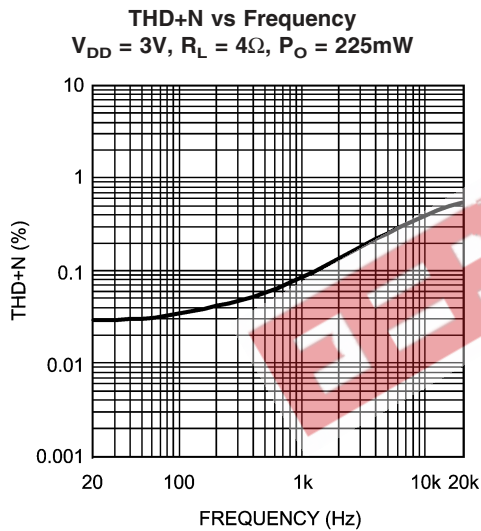
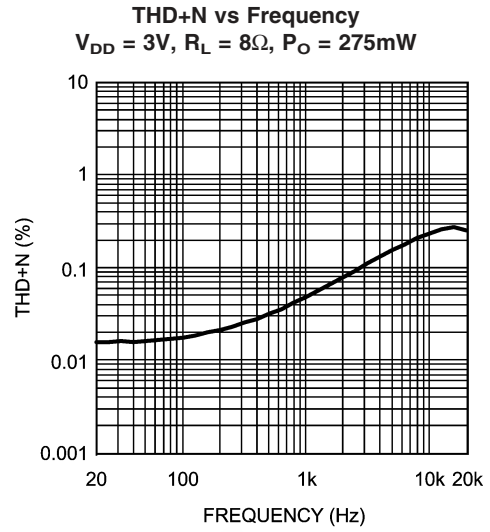
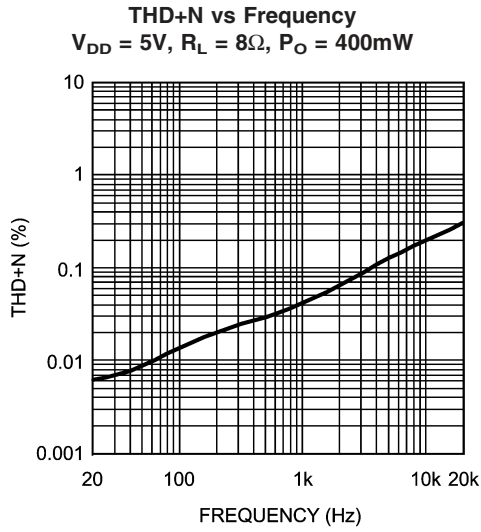

Typical Performance Characteristics Non-LD Specific Characteristics (Continued)

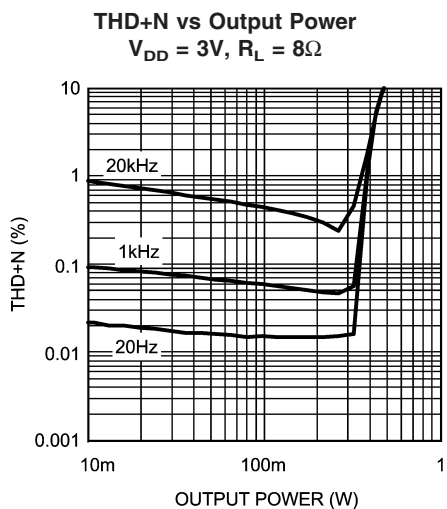

200645C0

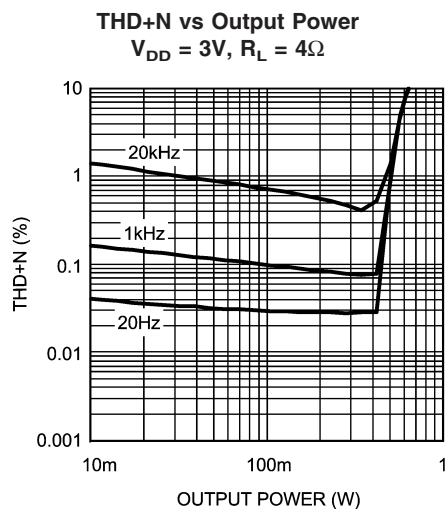

200645B9

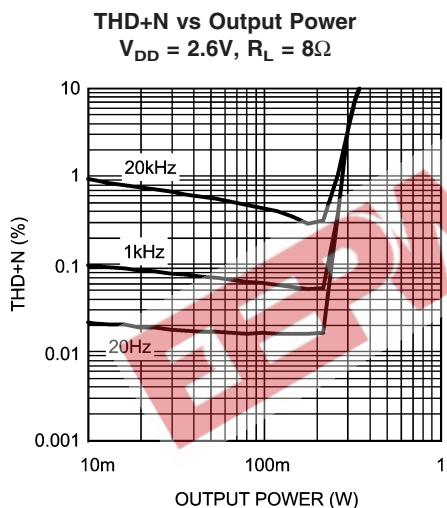

200645B8

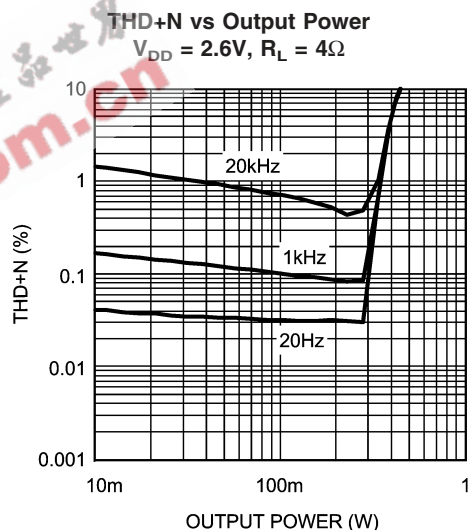

200645B7

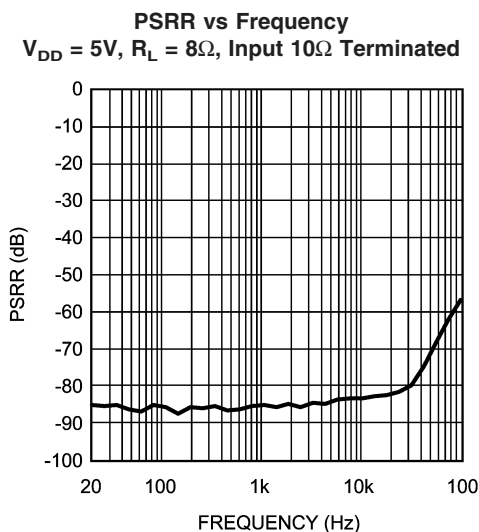

200645B0

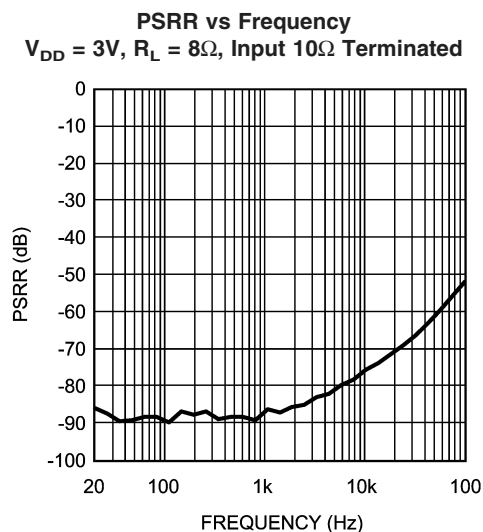

200645A9

Typical Performance Characteristics

Non-LD Specific Characteristics (Continued)

Output Power vs Supply Voltage
 $R_L = 8\Omega$

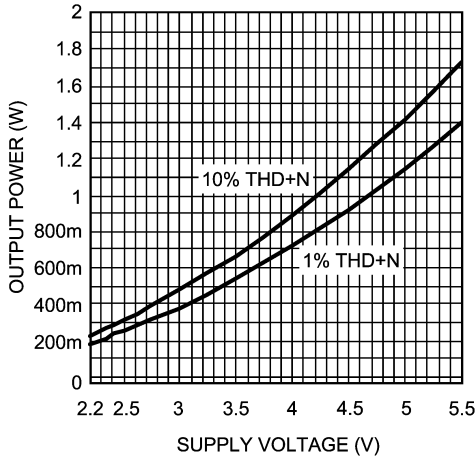

200645A6

Output Power vs Supply Voltage
 $R_L = 4\Omega$

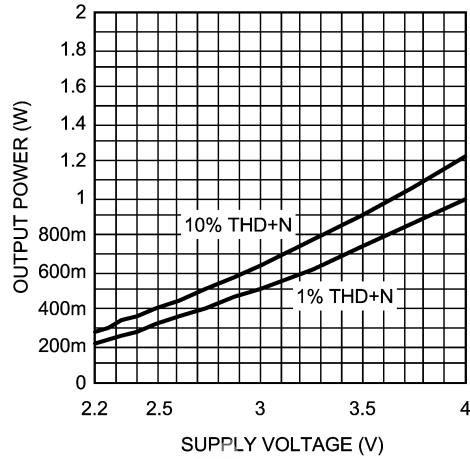

200645A5

Power Dissipation vs Output Power

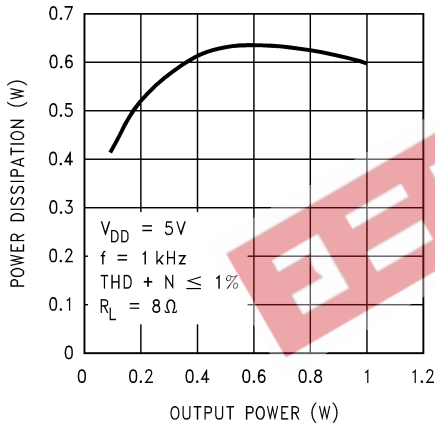

20064581

Power Dissipation vs Output Power

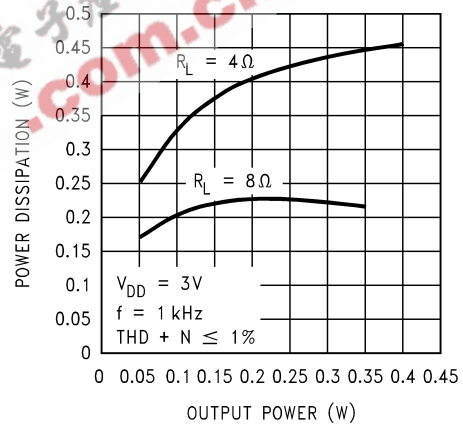

20064582

Power Dissipation vs Output Power

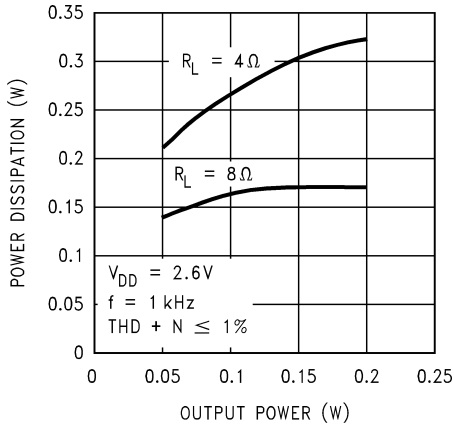

20064583

Output Power vs Load Resistance

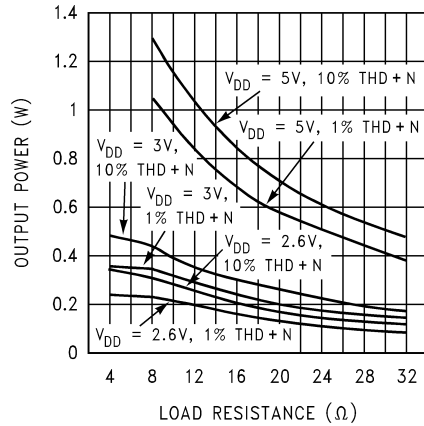

20064584

Typical Performance Characteristics

Non-LD Specific Characteristics (Continued)

Supply Current vs Shutdown Voltage
Shutdown Low

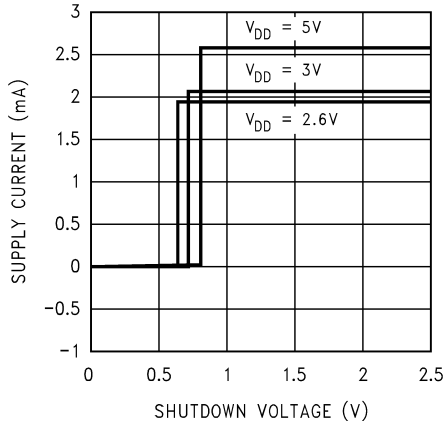

20064585

Supply Current vs Shutdown Voltage
Shutdown High

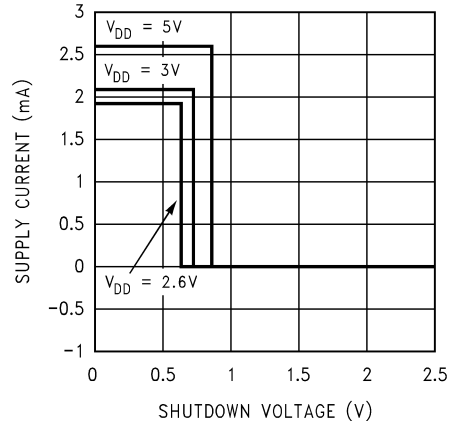

20064586

Clipping (Dropout) Voltage vs
Supply Voltage

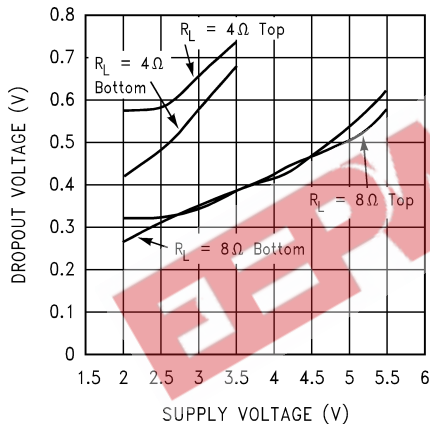

20064587

Open Loop Frequency Response

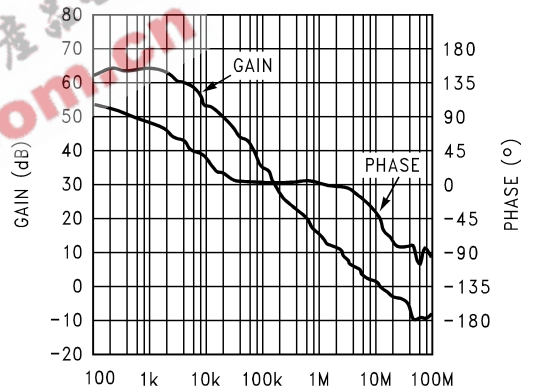

20064588

Power Derating Curve

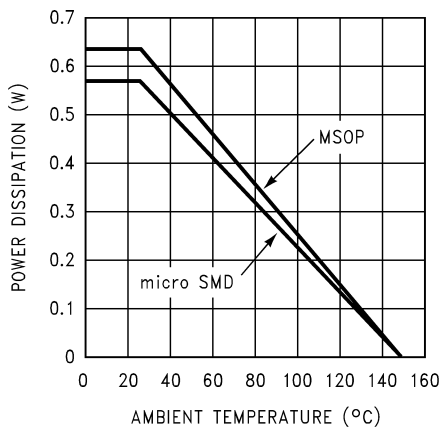

20064589

Noise Floor

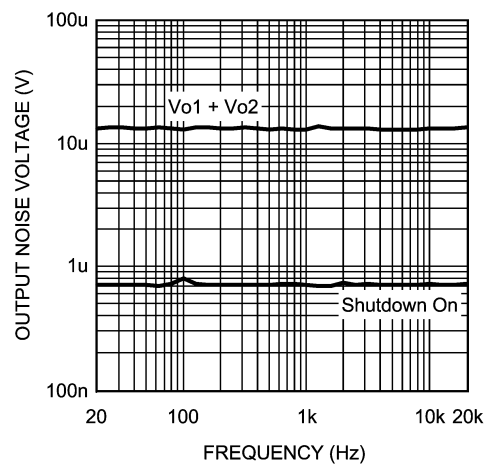

200645A4

Typical Performance Characteristics

Non-LD Specific Characteristics (Continued)

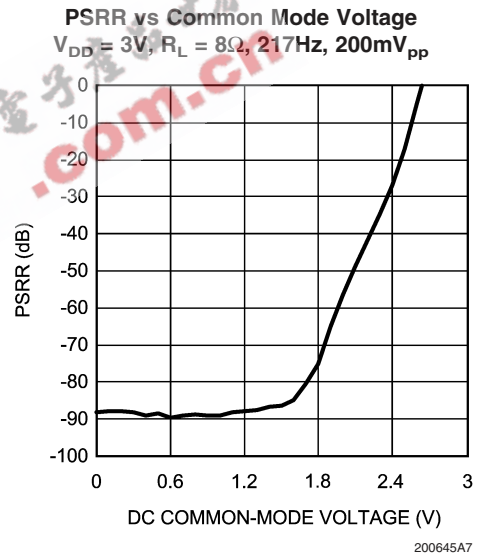
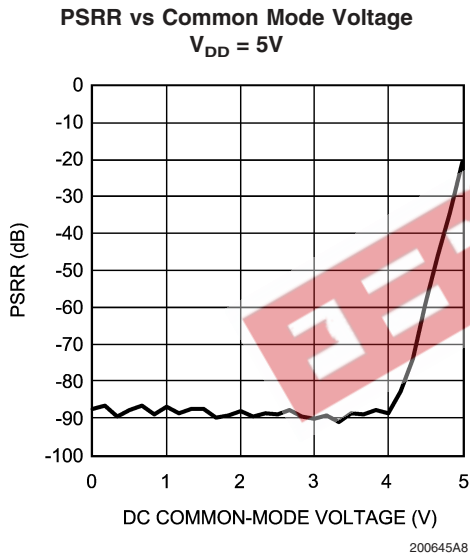
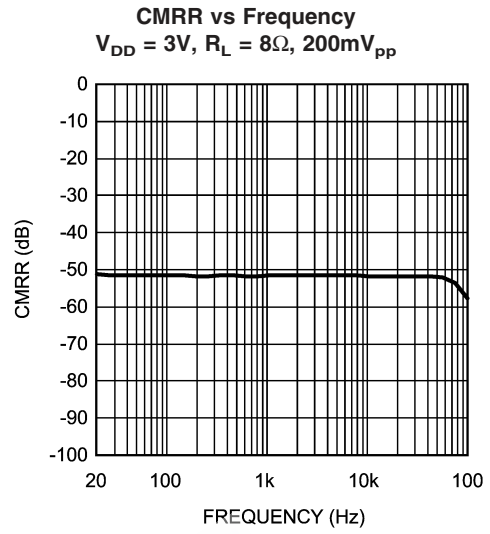
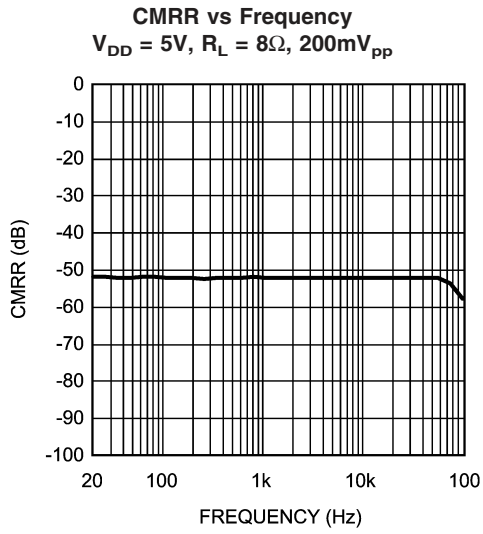

Application Information

DIFFERENTIAL AMPLIFIER EXPLANATION

The LM4899 is a fully differential audio amplifier that features differential input and output stages. Internally this is accomplished by two circuits: a differential amplifier and a common mode feedback amplifier that adjusts the output voltages so that the average value remains $V_{DD}/2$. The LM4899 features precisely matched internal gain-setting resistors, thus eliminating the need for external resistors and fixing the differential gain at $A_{VD} = 6\text{dB}$.

A differential amplifier works in a manner where the difference between the two input signals is amplified. In most applications, this would require input signals that are 180° out of phase with each other.

The LM4899 provides what is known as a "bridged mode" output (bridge-tied-load, BTL). This results in output signals at V_{o1} and V_{o2} that are 180° out of phase with respect to each other. Bridged mode operation is different from the single-ended amplifier configuration that connects the load between the amplifier output and ground. A bridged amplifier design has distinct advantages over the single-ended configuration: it provides differential drive to the load, thus doubling maximum possible output swing for a specific supply voltage. Four times the output power is possible compared with a single-ended amplifier under the same conditions. This increase in attainable output power assumes that the amplifier is not current limited or clipped.

A bridged configuration, such as the one used in the LM4899, also creates a second advantage over single-ended amplifiers. Since the differential outputs, V_{o1} and V_{o2} , are biased at half-supply, no net DC voltage exists across the load. BTL configuration eliminates the output coupling capacitor required in single-supply, single-ended amplifier configurations. If an output coupling capacitor is not used in a single-ended output configuration, the half-supply bias across the load would result in both increased internal IC power dissipation as well as permanent loudspeaker damage. Further advantages of bridged mode operation specific to fully differential amplifiers like the LM4899 include increased power supply rejection ratio, common-mode noise reduction, and click and pop reduction.

EXPOSED-DAP PACKAGE PCB MOUNTING CONSIDERATIONS

The LM4899's exposed-DAP (die attach paddle) package (LD) provide a low thermal resistance between the die and the PCB to which the part is mounted and soldered. This allows rapid heat transfer from the die to the surrounding PCB copper traces, ground plane and, finally, surrounding air. The result is a low voltage audio power amplifier that produces 1.4W at $\leq 1\%$ THD with a 4Ω load. This high power is achieved through careful consideration of necessary thermal design. Failing to optimize thermal design may compromise the LM4899's high power performance and activate unwanted, though necessary, thermal shutdown protection. The LD package must have its DAP soldered to a copper pad on the PCB. The DAP's PCB copper pad is connected to a large plane of continuous unbroken copper. This plane forms a thermal mass and heat sink and radiation area. Place the heat sink area on either outside plane in the case of a two-sided PCB, or on an inner layer of a board with more

than two layers. Connect the DAP copper pad to the inner layer or backside copper heat sink area with 4 (2x2) vias. The via diameter should be 0.012in - 0.013in with a 0.050in pitch. Ensure efficient thermal conductivity by plating-through and solder-filling the vias.

Best thermal performance is achieved with the largest practical copper heat sink area. If the heatsink and amplifier share the same PCB layer, a nominal 2.5in^2 (min) area is necessary for 5V operation with a 4Ω load. Heatsink areas not placed on the same PCB layer as the LM4899 should be 5in^2 (min) for the same supply voltage and load resistance. The last two area recommendations apply for 25°C ambient temperature. In all circumstances and conditions, the junction temperature must be held below 150°C to prevent activating the LM4899's thermal shutdown protection. The LM4899's power de-rating curve in the Typical Performance Characteristics shows the maximum power dissipation versus temperature. Example PCB layouts for the exposed-DAP TSSOP and LLP packages are shown in the Demonstration Board Layout section. Further detailed and specific information concerning PCB layout, fabrication, and mounting an LLP package is available from National Semiconductor's package Engineering Group under application note AN-1187.

PCB LAYOUT AND SUPPLY REGULATION CONSIDERATIONS FOR DRIVING 3Ω AND 4Ω LOADS

Power dissipated by a load is a function of the voltage swing across the load and the load's impedance. As load impedance decreases, load dissipation becomes increasingly dependent on the interconnect (PCB trace and wire) resistance between the amplifier output pins and the load's connections. Residual trace resistance causes a voltage drop, which results in power dissipated in the trace and not in the load as desired. For example, 0.1Ω trace resistance reduces the output power dissipated by a 4Ω load from 1.4W to 1.37W. This problem of decreased load dissipation is exacerbated as load impedance decreases. Therefore, to maintain the highest load dissipation and widest output voltage swing, PCB traces that connect the output pins to a load must be as wide as possible.

Poor power supply regulation adversely affects maximum output power. A poorly regulated supply's output voltage decreases with increasing load current. Reduced supply voltage causes decreased headroom, output signal clipping, and reduced output power. Even with tightly regulated supplies, trace resistance creates the same effects as poor supply regulation. Therefore, making the power supply traces as wide as possible helps maintain full output voltage swing.

POWER DISSIPATION

Power dissipation is a major concern when designing a successful amplifier, whether the amplifier is bridged or single-ended. Equation 2 states the maximum power dissipation point for a single-ended amplifier operating at a given supply voltage and driving a specified output load.

$$P_{\text{DMAX}} = (V_{\text{DD}})^2 / (2\pi^2 R_L) \text{ Single-Ended} \quad (1)$$

Application Information (Continued)

However, a direct consequence of the increased power delivered to the load by a bridge amplifier is an increase in internal power dissipation versus a single-ended amplifier operating at the same conditions.

$$P_{\text{DMAX}} = 4 \cdot (V_{\text{DD}})^2 / (2\pi^2 R_L) \text{ Bridge Mode} \quad (2)$$

Since the LM4899 has bridged outputs, the maximum internal power dissipation is 4 times that of a single-ended amplifier. Even with this substantial increase in power dissipation, the LM4899 does not require additional heatsinking under most operating conditions and output loading. From Equation 3, assuming a 5V power supply and an 8Ω load, the maximum power dissipation point is 625mW. The maximum power dissipation point obtained from Equation 3 must not be greater than the power dissipation results from Equation 4:

$$P_{\text{DMAX}} = (T_{\text{JMAX}} - T_{\text{A}}) / \theta_{\text{JA}} \quad (3)$$

The LM4899's θ_{JA} in an MUA10A package is 190°C/W. Depending on the ambient temperature, T_{A} , of the system surroundings, Equation 4 can be used to find the maximum internal power dissipation supported by the IC packaging. If the result of Equation 3 is greater than that of Equation 4, then either the supply voltage must be decreased, the load impedance increased, the ambient temperature reduced, or the θ_{JA} reduced with heatsinking. In many cases, larger traces near the output, V_{DD} , and GND pins can be used to lower the θ_{JA} . The larger areas of copper provide a form of heatsinking allowing higher power dissipation. For the typical application of a 5V power supply, with an 8Ω load, the maximum ambient temperature possible without violating the maximum junction temperature is approximately 30°C provided that device operation is around the maximum power dissipation point. Recall that internal power dissipation is a function of output power. If typical operation is not around the maximum power dissipation point, the LM4899 can operate at higher ambient temperatures. Refer to the **Typical Performance Characteristics** curves for power dissipation information.

POWER SUPPLY BYPASSING

As with any power amplifier, proper supply bypassing is critical for low noise performance and high power supply rejection ratio (PSRR). The capacitor location on both the

bypass and power supply pins should be as close to the device as possible. A larger half-supply bypass capacitor improves PSRR because it increases half-supply stability. Typical applications employ a 5V regulator with 10μF and 0.1μF bypass capacitors that increase supply stability. This, however, does not eliminate the need for bypassing the supply nodes of the LM4899. Although the LM4899 will operate without the bypass capacitor C_{B} , although the PSRR may decrease. A 1μF capacitor is recommended for C_{B} . This value maximizes PSRR performance. Lesser values may be used, but PSRR decreases at frequencies below 1kHz. The issue of C_{B} selection is thus dependant upon desired PSRR and click and pop performance.

SHUTDOWN FUNCTION

In order to reduce power consumption while not in use, the LM4899 contains shutdown circuitry that is used to turn off the amplifier's bias circuitry. In addition, the LM4899 contains a Shutdown Mode pin, allowing the designer to designate whether the part will be driven into shutdown with a high level logic signal or a low level logic signal. This allows the designer maximum flexibility in device use, as the Shutdown Mode pin may simply be tied permanently to either V_{DD} or GND to set the LM4899 as either a "shutdown-high" device or a "shutdown-low" device, respectively. The device may then be placed into shutdown mode by toggling the Shutdown Select pin to the same state as the Shutdown Mode pin. For simplicity's sake, this is called "shutdown same", as the LM4899 enters shutdown mode whenever the two pins are in the same logic state. The trigger point for either shutdown high or shutdown low is shown as a typical value in the Supply Current vs Shutdown Voltage graphs in the **Typical Performance Characteristics** section. It is best to switch between ground and supply for maximum performance. While the device may be disabled with shutdown voltages in between ground and supply, the idle current may be greater than the typical value of 0.1μA. In either case, the shutdown pin should be tied to a definite voltage to avoid unwanted state changes.

In many applications, a microcontroller or microprocessor output is used to control the shutdown circuitry, which provides a quick, smooth transition to shutdown. Another solution is to use a single-throw switch in conjunction with an external pull-up resistor (or pull-down, depending on shutdown high or low application). This scheme guarantees that the shutdown pin will not float, thus preventing unwanted state changes.

Physical Dimensions inches (millimeters)
unless otherwise noted

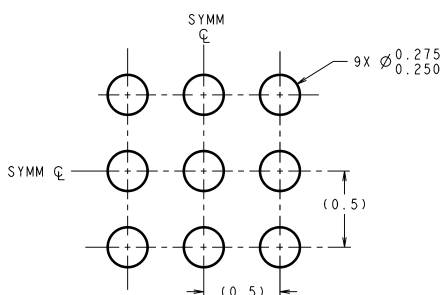

DIMENSIONS ARE IN MILLIMETERS

LAND PATTERN RECOMMENDATION

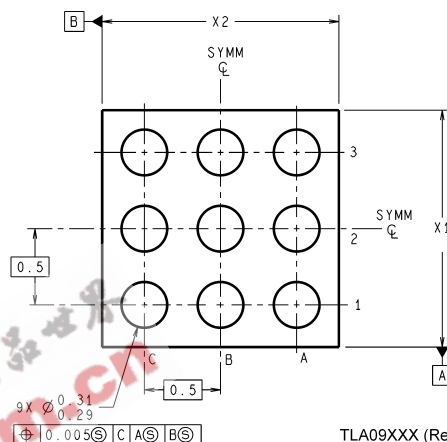
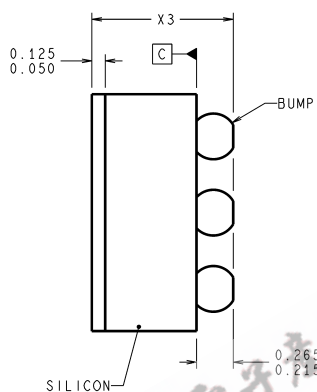
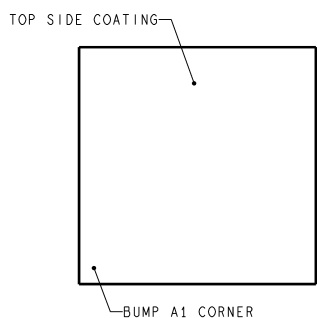

TLA09XXX (Rev B)

9-Bump micro SMD
Order Number LM4899ITL
NS Package Number TLA09AAA
X1 = 1.514±0.03 X2 = 1.514±0.03 X3 = 0.600±0.075

Physical Dimensions inches (millimeters) unless otherwise noted (Continued)

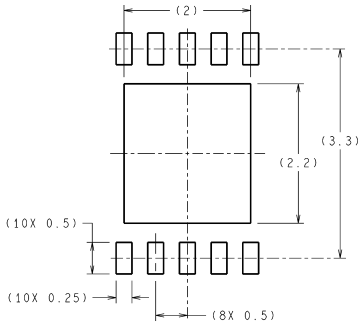

DIMENSIONS ARE IN MILLIMETERS
DIMENSIONS IN () FOR REFERENCE ONLY

RECOMMENDED LAND PATTERN
1:1 RATIO WITH PKG SOLDER PADS

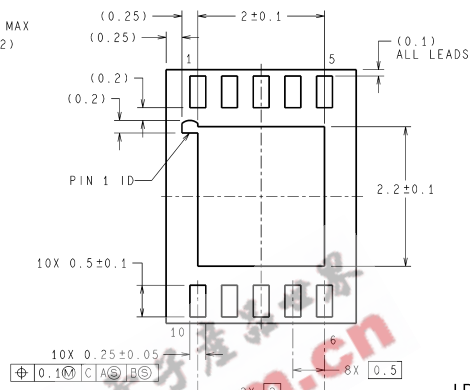
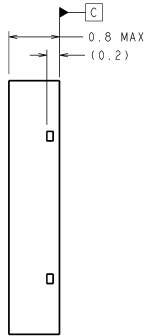
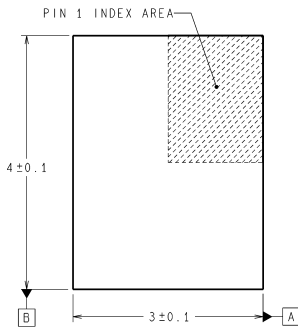

LDA10B (Rev B)

LLP
Order Number LM4899LD
NSPackage Number LDA10B

