

M210x Series

5x7 mm, 3.3/2.5/1.8 Volt, LVPECL/LVDS/CML, Clock Oscillator

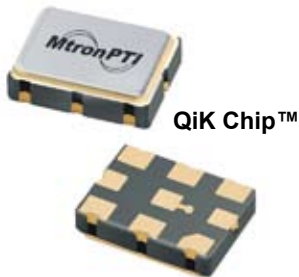

Ordering Information

	M210	0	6	8	B	P	N	00.0000	MHz
Product Series									
Supply Voltage									
0: 3.3 V	1: 2.5 V								
2: 1.8 V									
Temperature Range									
2: -40°C to +85°C (see Note 1)									
6: -20°C to +70°C									
Stability									
4: ±50 ppm	3: 100 ppm								
8: ±20 ppm									
Enable/Disable									
B: Enable High (pin 1)	G: Enable High (pin 2)								
S: Enable Low (pin 1)	M: Enable Low (pin 2)								
U: No Enable/Disable									
Logic Type									
P: LVPECL	L: LVDS								
M: CML									
Package/Lead Configuration									
N: 5x7 mm Leadless									
Frequency (customer specified)									

Features:

- Featuring **QIK Chip™** Technology
- Superior Jitter Performance (comparable to SAW based)
- Frequencies from 150 MHz to 1.4 GHz
- Designed for a short 2 week cycle time

Applications:

- Telecommunications such as SONET / SDH / DWDM / FEC / SERDES / OC-3 thru OC-192
- Wireless base stations / WLAN / Gigabit Ethernet
- Avionic flight controls and military communications

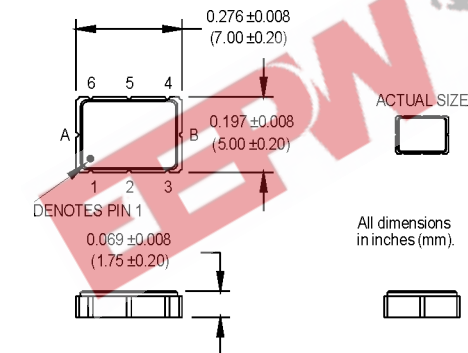

PIN 1 ENABLE

- Pad1: Enable/Disable
- Pad2: N/C
- Pad3: Ground
- Pad4: Output Q (LVPECL, LVDS, CML)
- Pad5: Output \bar{Q} (LVPECL, LVDS, CML)
- Pad6: Vcc
- PadA: Do not connect!
- PadB: Do not connect!
- PadC: Do not connect!

PIN 2 ENABLE

- Pad1: N/C
- Pad2: Enable/Disable
- Pad3: Ground
- Pad4: Output Q (LVPECL, LVDS, CML)
- Pad5: Output \bar{Q} (LVPECL, LVDS, CML)
- Pad6: Vcc
- PadA: Do not connect!
- PadB: Do not connect!
- PadC: Do not connect!

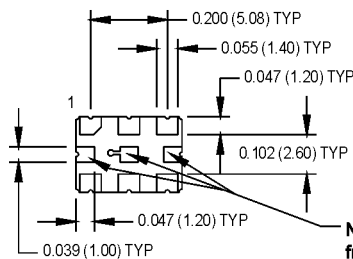

NOTE: These 3 pads must be isolated from any traces or vias appearing beneath this port.

SUGGESTED SOLDER PAD LAYOUT

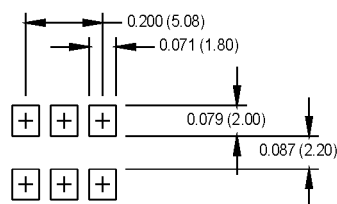

M210x Series

5x7 mm, 3.3/2.5/1.8 Volt, LVPECL/LVDS/CML, Clock Oscillator



PARAMETER	Symbol	Min.	Typ.	Max.	Units	Condition/Notes	
Frequency Range	F	150		1400	MHz	See Note 2	
Operating Temperature	T _A	(See ordering information)					See Note 1
Storage Temperature	T _s	-55		+125	°C		
Frequency Stability	ΔF/F	(See ordering information)					See Note 3
Aging							
1st Year		-3		+3	ppm		
Thereafter (per year)		-1		+1	ppm		
Supply Voltage	V _{cc}	1.71	1.8	1.89	V		
		2.375	2.5	2.625	V		
		3.135	3.3	3.465	V		
Input Current	I _{cc}			125	mA	LVPECL/LVDS/CML	
Load		50 Ohms to (V _{cc} -2) V _{dc} 100 Ohm differential load				See Note 4 LVPECL Waveform LVDS/CML Waveform	
Symmetry (Duty Cycle)		45		55	%	@ 50% of waveform	
Output Skew			TBD				
Differential Voltage		350	425 TBD	500	mVppd	LVDS CML	
Common Mode Output Voltage	V _{cm}		1.2		V	LVDS	
Logic "1" Level	V _{oh}	V _{cc} -1.02			V	LVPECL	
Logic "0" Level	V _{ol}			V _{cc} -1.63	V	LVPECL	
Rise/Fall Time	T _r /T _f		0.23	0.50	ns	@ 20/80% LVPECL	
Enable Function		80% V _{cc} min. or N/C: output active 20% V _{cc} max.: output disables to high-Z				Output Option B or G	
		20% V _{cc} max.: output active 80% V _{cc} min.: output disables to high-Z				Output Option S or M	
Start up Time			10		ms		
Phase Jitter @ 622.08 MHz	φ _J		0.3		ps RMS	Integrated 12 kHz – 20 MHz	
Phase Noise						@ 622.08 MHz	
10 Hz			-50			dBc/Hz	
100 Hz			-80			dBc/Hz	
1 KHz			-106			dBc/Hz	
10 KHz			-117			dBc/Hz	
100 KHz			-120			dBc/Hz	
1 MHz			-130			dBc/Hz	
10 MHz			-147			dBc/Hz	
40 MHz			-150			dBc/Hz	
Mechanical Shock		Per MIL-STD-202, Method 213, Condition C (100 g's, 6 ms duration, ½ sinewave)					
Vibration		Per MIL-STD-202, Method 201 & 204 (10 g's from 10-2000 Hz)					
Hermeticity		Per MIL-STD-202, Method 112, (1x10 ⁻⁸ atm. cc/s of Helium)					
Thermal Cycle		Per MIL-STD-883, Method 1010, Condition B (-55°C to +125°C, 15 min. dwell, 10 cycles)					
Solderability		Per EIAJ-STD-002					
Soldering Conditions		+260°C max. for 10 secs.					

Note 1: If the device is powered up below -20°C and then the ambient temperature rises 105°C during normal operation, the output will be interrupted for approximately 2-3 ms. A correction is in process and will be available Q1 2007.

Note 2: Contact factory for exact frequency availability over 945 MHz

Note 3: Stability is inclusive of initial tolerance, deviation over temperature, shock, vibration, supply voltage, and aging for one year at 50°C mean ambient temperature.

Note 4: See Load Circuit Diagram in this Datasheet. Consult factory with nonstandard output load requirements.

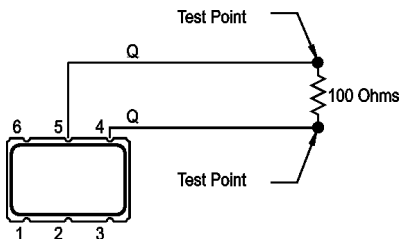

LVDS Load Circuit

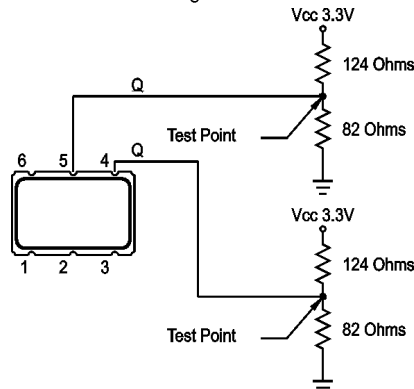

3.3V LVPECL Load Circuit

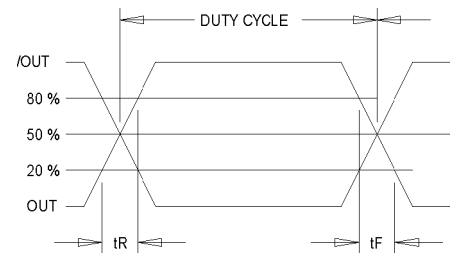

Output Waveform: LVDS/CML/PECL

MtronPTI reserves the right to make changes to the product(s) and service(s) described herein without notice. No liability is assumed as a result of their use or application.

Please see www.mtronpti.com for our complete offering and detailed datasheets. Contact us for your application specific requirements: MtronPTI 1-800-762-8800.

MtronPTI Lead Free Solder Profile

