

## 1.0A SURFACE MOUNT GLASS PASSIVATED STANDARD DIODE

### Features

- Glass Passivated Die Construction
- Ideally Suited for Automatic Assembly
- Low Forward Voltage Drop
- Surge Overload Rating to 30A Peak
- Low Power Loss
- Built-in Strain Relief
- Plastic Case Material has UL Flammability Classification Rating 94V-O

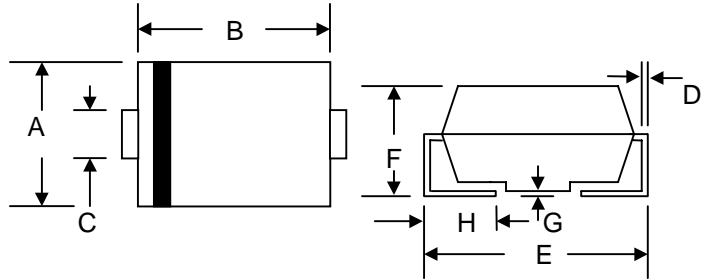

### Mechanical Data

- Case: SMB/DO-214AA, Molded Plastic
- Terminals: Solder Plated, Solderable per MIL-STD-750, Method 2026
- Polarity: Cathode Band or Cathode Notch
- Marking: Type Number
- Weight: 0.093 grams (approx.)
- **Lead Free: For RoHS / Lead Free Version, Add "-LF" Suffix to Part Number, See Page 4**

SMB/DO-214AA		
Dim	Min	Max
A	3.30	3.94
B	4.06	4.70
C	1.91	2.11
D	0.152	0.305
E	5.08	5.59
F	2.13	2.44
G	0.051	0.203
H	0.76	1.27
All Dimensions in mm		

### Maximum Ratings and Electrical Characteristics @T<sub>A</sub>=25°C unless otherwise specified

Characteristic	Symbol	S1A	S1B	S1D	S1G	S1J	S1K	S1M	Unit
Peak Repetitive Reverse Voltage Working Peak Reverse Voltage DC Blocking Voltage	V <sub>RRM</sub> V <sub>RWM</sub> V <sub>R</sub>	50	100	200	400	600	800	1000	V
RMS Reverse Voltage	V <sub>R(RMS)</sub>	35	70	140	280	420	560	700	V
Average Rectified Output Current @T <sub>L</sub> = 100°C	I <sub>O</sub>	1.0							A
Non-Repetitive Peak Forward Surge Current 8.3ms Single half sine-wave superimposed on rated load (JEDEC Method)	I <sub>FSM</sub>	30							A
Forward Voltage @I <sub>F</sub> = 1.0A	V <sub>FM</sub>	1.10							V
Peak Reverse Current @T <sub>A</sub> = 25°C At Rated DC Blocking Voltage @T <sub>A</sub> = 125°C	I <sub>RM</sub>	5.0 200							μA
Reverse Recovery Time (Note 1)	t <sub>rr</sub>	2.5							μS
Typical Junction Capacitance (Note 2)	C <sub>j</sub>	15							pF
Typical Thermal Resistance (Note 3)	R <sub>θJL</sub>	30							°C/W
Operating and Storage Temperature Range	T <sub>j</sub> , T <sub>STG</sub>	-65 to +175							°C

- Note: 1. Measured with I<sub>F</sub> = 0.5A, I<sub>R</sub> = 1.0A, I<sub>rr</sub> = 0.25A,  
 2. Measured at 1.0 MHz and applied reverse voltage of 4.0 V DC.  
 3. Mounted on P.C. Board with 8.0mm<sup>2</sup> land area.

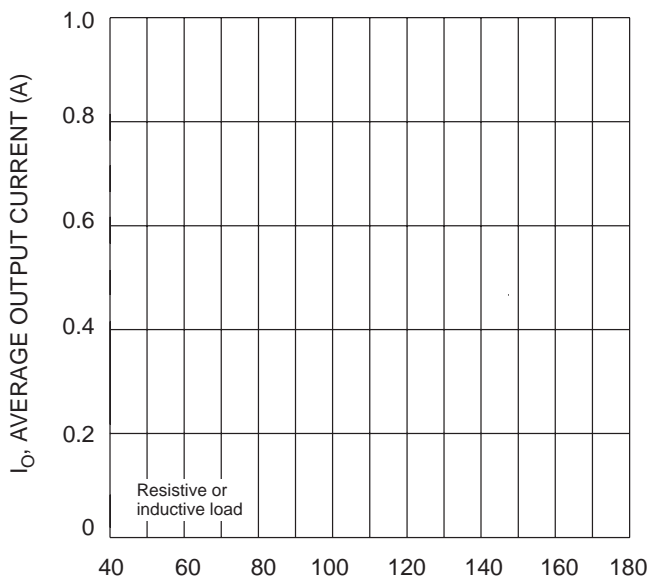

$T_L$ , LEAD TEMPERATURE ( °C )  
Fig. 1 Forward Current Derating Curve

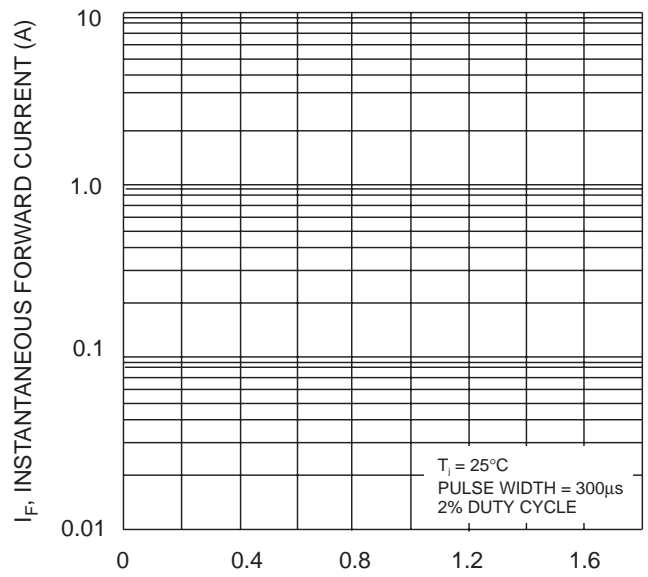

$V_F$ , INSTANTANEOUS FORWARD VOLTAGE (V)  
Fig. 2 Typical Forward Characteristics

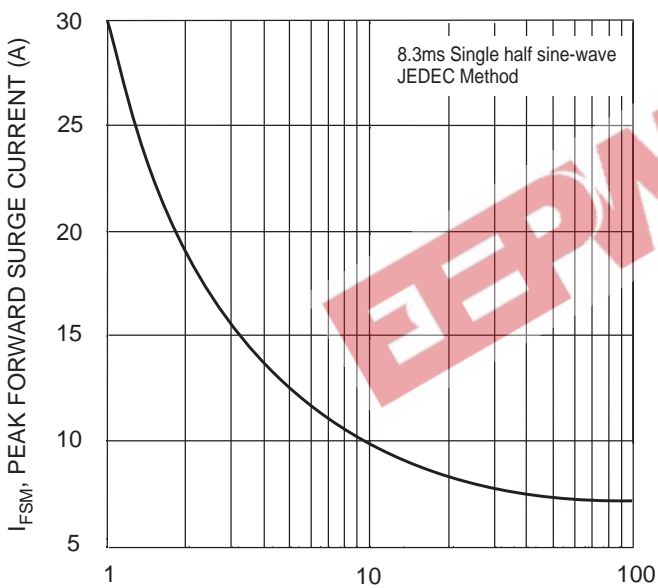

NUMBER OF CYCLES @ 60Hz  
Fig. 3 Max Non-Repetitive Peak Fwd Surge Current

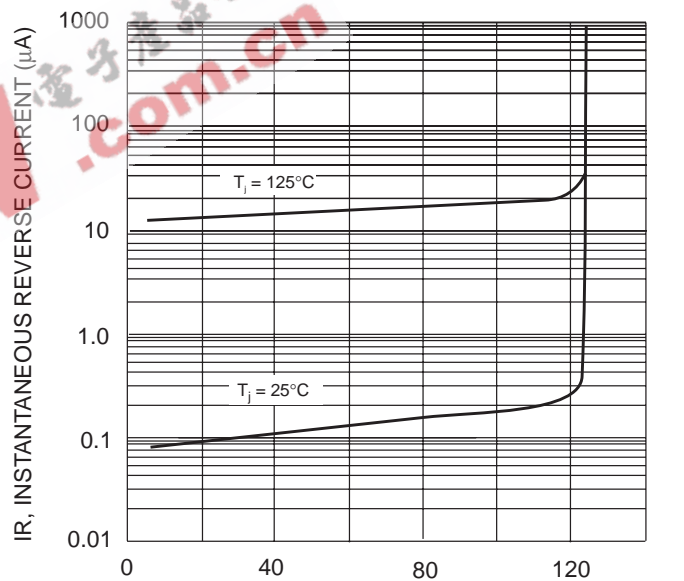

PERCENT OF RATED PEAK REVERSE VOLTAGE (%)  
Fig. 4 Typical Reverse Characteristics

## MARKING INFORMATION

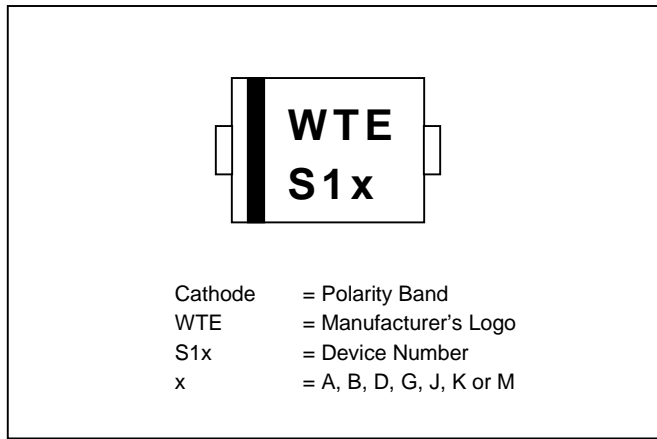

## RECOMMENDED FOOTPRINT

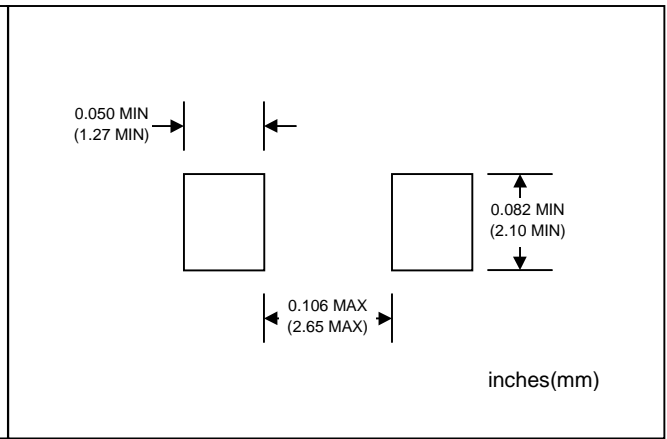

## PACKAGING INFORMATION

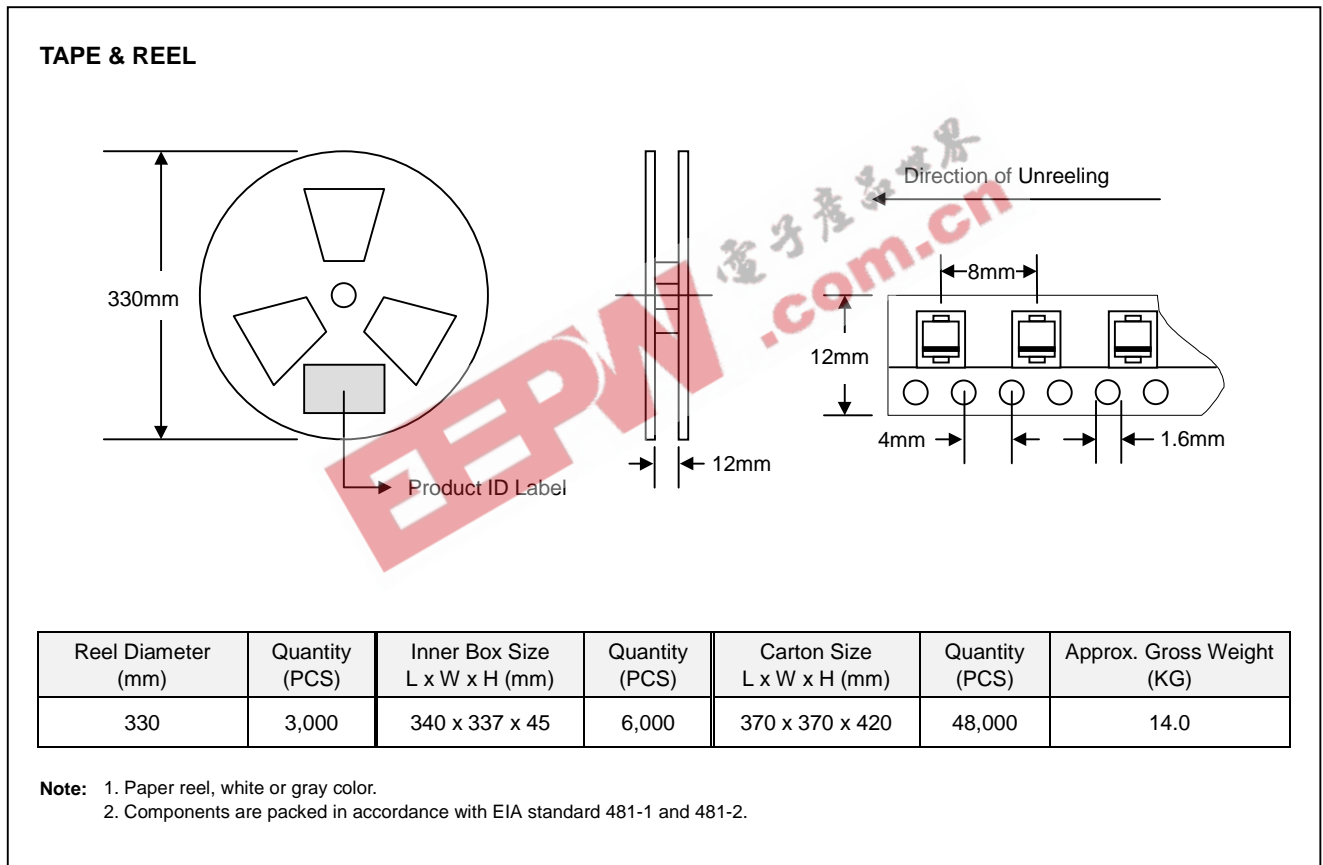

## ORDERING INFORMATION

Product No.	Package Type	Shipping Quantity
S1A-T3	SMB	3000/Tape & Reel
S1B-T3	SMB	3000/Tape & Reel
S1D-T3	SMB	3000/Tape & Reel
S1G-T3	SMB	3000/Tape & Reel
S1J-T3	SMB	3000/Tape & Reel
S1K-T3	SMB	3000/Tape & Reel
S1M-T3	SMB	3000/Tape & Reel

1. Shipping quantity given is for minimum packing quantity only. For minimum order quantity, please consult the Sales Department.
2. **To order RoHS / Lead Free version (with Lead Free finish), add "-LF" suffix to part number above. For example, S1A-T3-LF.**

EEPW 电子產品世界  
.com.cn

Won-Top Electronics Co., Ltd (WTE) has checked all information carefully and believes it to be correct and accurate. However, WTE cannot assume any responsibility for inaccuracies. Furthermore, this information does not give the purchaser of semiconductor devices any license under patent rights to manufacturer. WTE reserves the right to change any or all information herein without further notice.

**WARNING:** DO NOT USE IN LIFE SUPPORT EQUIPMENT. WTE power semiconductor products are not authorized for use as critical components in life support devices or systems without the express written approval.

### Won-Top Electronics Co., Ltd.

No. 44 Yu Kang North 3rd Road, Chine Chen Dist., Kaohsiung, Taiwan

**Phone:** 886-7-822-5408 or 886-7-822-5410

**Fax:** 886-7-822-5417

**Email:** sales@wontop.com

**Internet:** <http://www.wontop.com>

*We power your everyday.*