

The SL2524 is a pin compatible replacement for the SL2521 and SL2522 series of log amplifiers, and exhibits a superior stability performance. The amplifier is a successive detection type which provides linear gain and accurate logarithmic signal compression over a wide bandwidth. The two stages can be operated independently.

When six stages (three SL2524s) are cascaded the strip can be used for IFs between 30-650MHz whilst achieving greater than 65dB dynamic range with a log accuracy of  $<\pm 1.0\text{dB}$ . The balanced limited output also offers accurate phase information with input amplitude.

### FEATURES

- 1.3GHz Bandwidth (-3dB)
- Balanced IF limiting
- 3ns Rise Times/5ns Fall Times (six stages)
- 20ns Pulse Handling (six stages)
- Temperature Stabilised
- Surface Mountable

### APPLICATIONS

- Ultra Wideband Log Receivers
- Channelised Receivers
- Monopulse Applications

### ABSOLUTE MAXIMUM RATINGS

Supply Voltage ( $V_{CC}$ above $V_{EE}$ )	+7.0V
Storage temperature	-65°C to +150°C
Operating temperature range	
SL2524/B/LC	-40°C to +85°C
SL2524/C/HP	-30°C to +85°C
Junction temperature - LC20	+175°C
- HP20	+150°C
Applied DC voltage to RF input $\pm 0.4\text{V}$ (between RF I/P pins)	
Applied RF power to RF input	+15dBm
Value of $R_{SET}$ resistors	NOT less than 180Ω
Thermal resistance:-	
Die to case - LC 20	28°C/W
- HP20	20°C/W
Die to ambient - LC20	73°C/W
- HP20	82°C/W

### ORDERING INFORMATION

SL2524/B/LC (Ceramic leadless chip carrier package)  
 SL2524/C/HP (Plastic J lead chip carrier package)  
 SL2524/NA/1C (DC probe tested bare die)  
 5962 - 92315 (SMD)

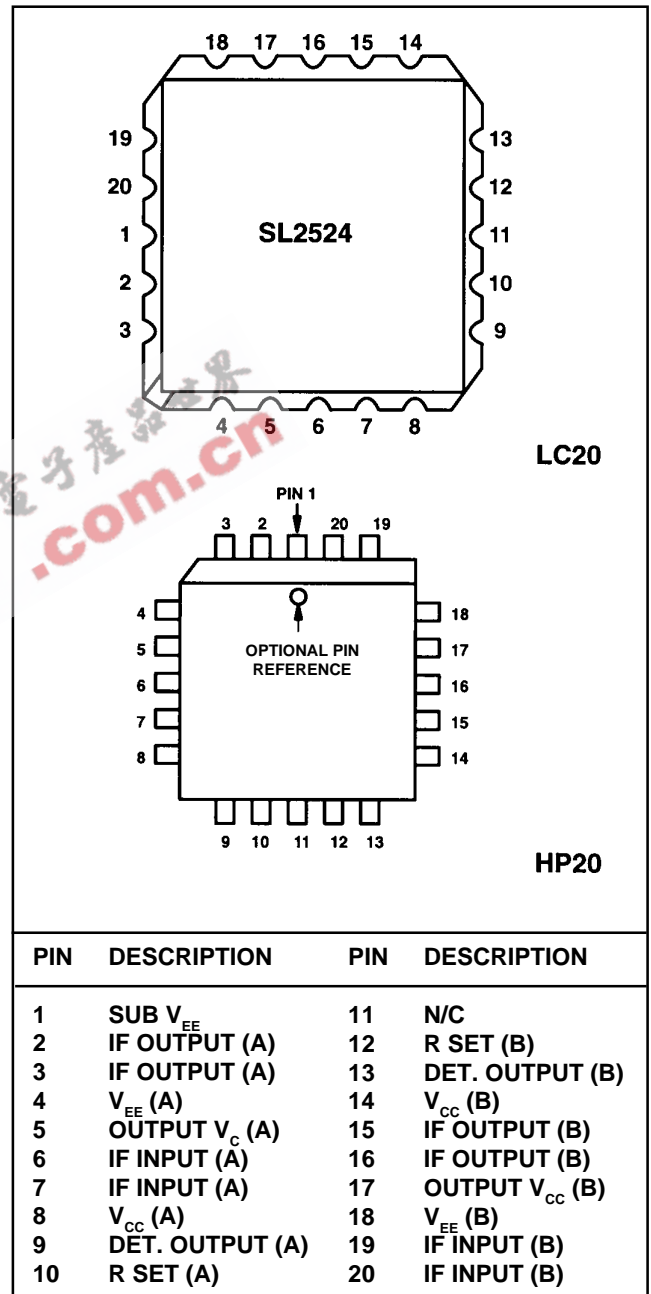

Fig.1 Pin connections top view

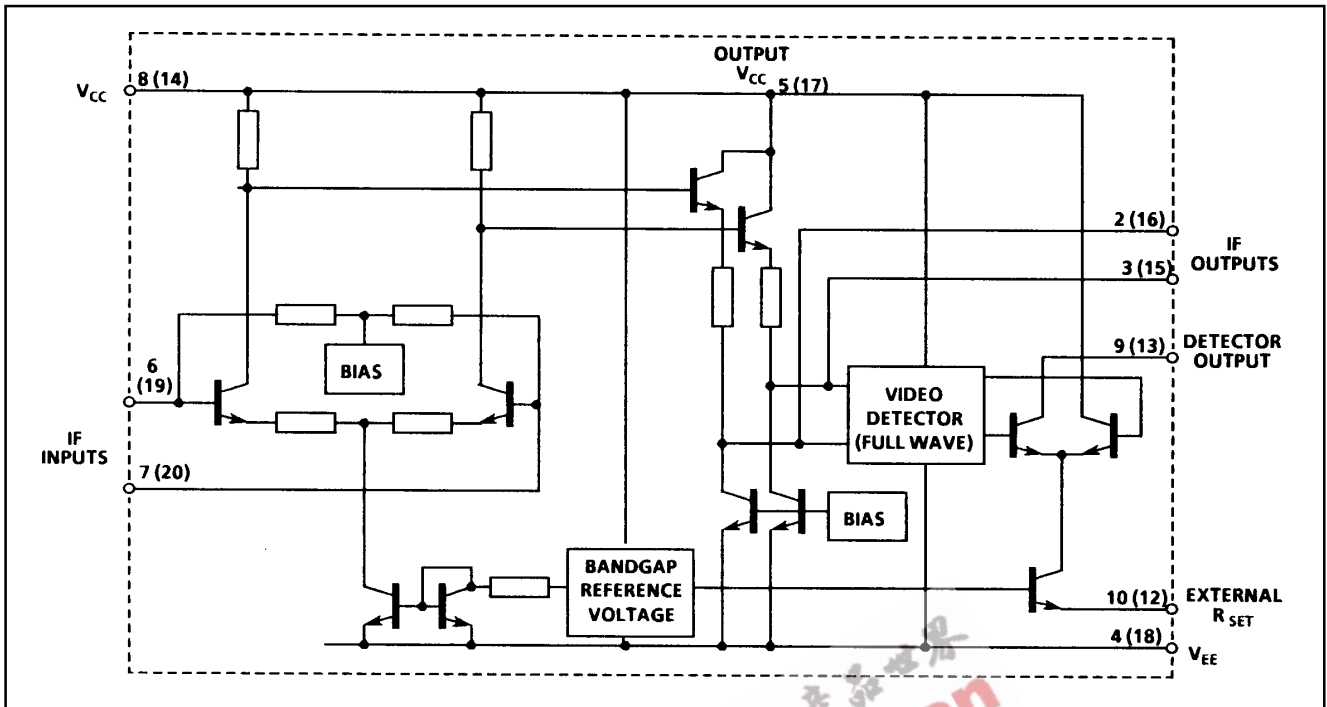

Fig.2 Circuit diagram of single stage A - (stage B pin Nos bracketed)

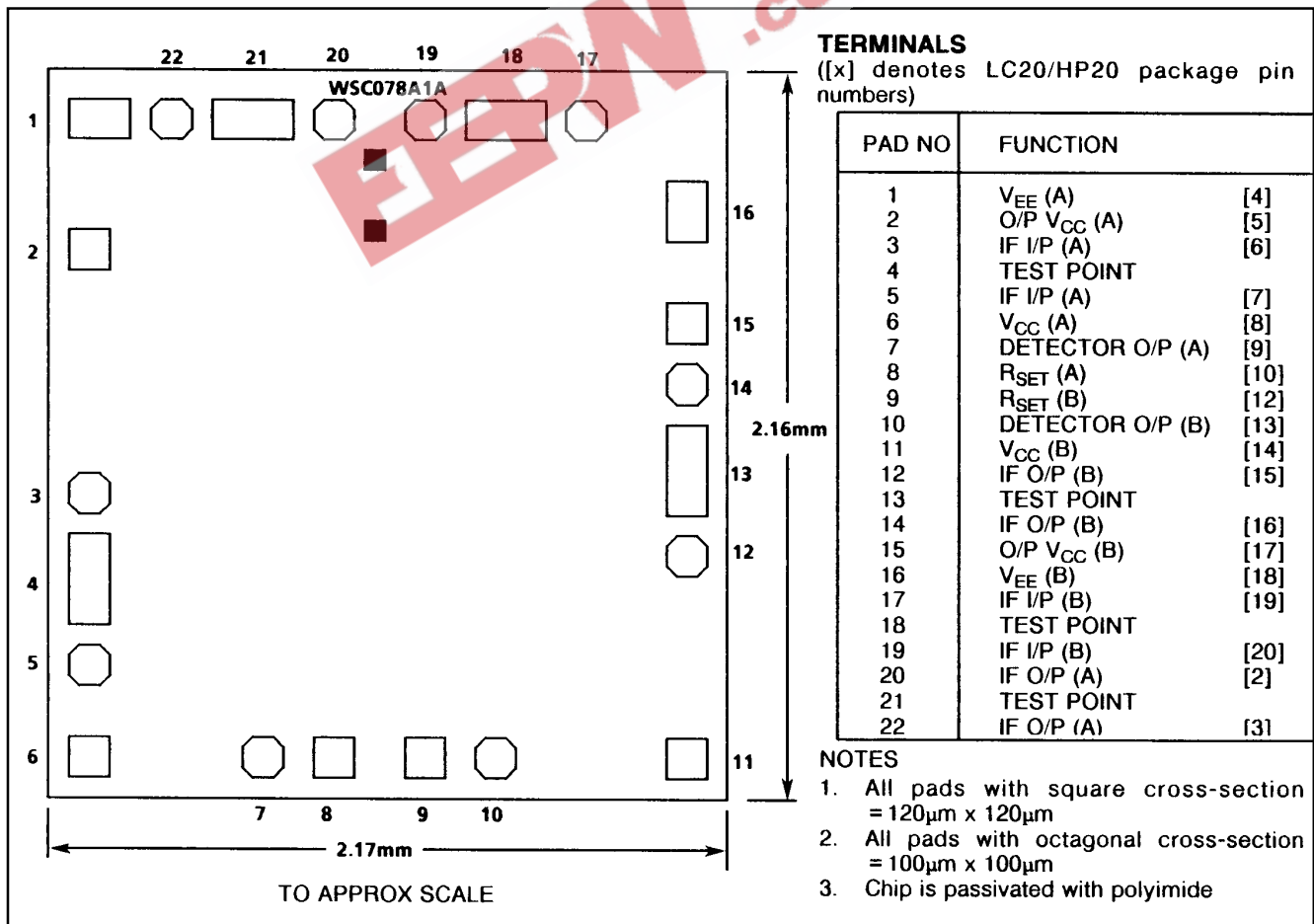

Fig.3 Pad map for SL2524 naked die

**ELECTRICAL CHARACTERISTICS - SL2524B****Guaranteed at the following test conditions unless otherwise stated**Frequency = 200MHz,  $T_{amb} = +25^{\circ}\text{C}$ , Input power = -30dBm,  $V_{CC} = 6\text{V} \pm 0.1\text{V}$ , Source Impedance = 50 $\Omega$ .Load impedance = 50 $\Omega$ , Test Circuit = Fig. 4,  $R_{SET} = 300\Omega$ . Tested as a dual stage.

Characteristic	Value			Units	Conditions
	Min	Typ	Max		
Supply current	70	87	100	mA	
Small signal gain (dual stage, single ended)	9.6	11.4	13.0	dB	$T_{amb} = +25^{\circ}\text{C}$ f = 25MHz See Notes 1, 3
	10.1	11.6	13.1	dB	$T_{amb} = -40^{\circ}\text{C}$ f = 200MHz See Notes 2, 3
	9.9	11.3	12.7	dB	$T_{amb} = +25^{\circ}\text{C}$ f = 200MHz See Note 3
	9.5	11.0	12.5	dB	$T_{amb} = +85^{\circ}\text{C}$ f = 200MHz See Notes 2, 3
	9.7	11.2	12.7	dB	$T_{amb} = -40^{\circ}\text{C}$ f = 500MHz See Notes 2, 3
	9.3	10.7	12.1	dB	$T_{amb} = +25^{\circ}\text{C}$ f = 500MHz See Note 3
	8.2	9.7	11.2	dB	$T_{amb} = +85^{\circ}\text{C}$ f = 500MHz See Notes 2, 3
Detected output current (max)	3.20	3.45	3.70	mA	$T_{amb} = +25^{\circ}\text{C}$ , $V_{IN} = 0\text{dBm}$ , f = 25MHz See Note 1
	3.05	3.25	3.45	mA	$T_{amb} = -40^{\circ}\text{C}$ , $V_{IN} = 0\text{dBm}$ , f = 200MHz See Note 2
	3.15	3.30	3.45	mA	$T_{amb} = +25^{\circ}\text{C}$ , $V_{IN} = 0\text{dBm}$ , f = 200MHz
	3.10	3.30	3.50	mA	$T_{amb} = +85^{\circ}\text{C}$ , $V_{IN} = 0\text{dBm}$ , f = 200MHz See Note 2
	2.80	3.10	3.30	mA	$T_{amb} = -40^{\circ}\text{C}$ , $V_{IN} = 0\text{dBm}$ , f = 500MHz See Note 2
	2.90	3.15	3.45	mA	$T_{amb} = +25^{\circ}\text{C}$ , $V_{IN} = 0\text{dBm}$ , f = 500MHz
	2.85	3.10	3.65	mA	$T_{amb} = +85^{\circ}\text{C}$ , $V_{IN} = 0\text{dBm}$ , f = 500MHz See Note 2
Detected output current (no signal)	0.85	0.95	1.15	mA	$T_{amb} = -40^{\circ}\text{C}$ , See Note 2
	0.80	0.93	1.10	mA	$T_{amb} = +25^{\circ}\text{C}$ , See Note 2
	0.80	0.90	1.10	mA	$T_{amb} = +85^{\circ}\text{C}$ , See Note 2
Upper cut off frequency (RF)	600	1100		MHz	-3dB w.r.t 200MHz, $T_{amb} = -40^{\circ}\text{C}$ See Note 2
	900	1100		MHz	-3dB w.r.t 200MHz, $T_{amb} = +25^{\circ}\text{C}$
	600	800		MHz	-3dB w.r.t 200MHz, $T_{amb} = +85^{\circ}\text{C}$ See Note 2
Lower cut off frequency (RF)		0.35	1	MHz	-3dB w.r.t 200MHz, $T_{amb} = +25^{\circ}\text{C}$
Detector cut off frequency		700		MHz	50% O/P current w.r.t. 200MHz
Limited IF O/P voltage	135	155	175	mV	I/P power = 0dBm, $T_{amb} = +25^{\circ}\text{C}$
Phase variation with input level (normalised to -30dBm)		0 $\pm$ 2.0	0 $\pm$ 3.0	Degree	Frequency = 70MHz, -55 to +3dBm See Note 2
		-4.0 $\pm$ 2.0	-4.0 $\pm$ 3.0	Degree	Frequency = 200MHz, -55 to +3dBm See Note 2
Limited O/P var with temp.		$\pm$ 12	$\pm$ 25	mV	See Note 1
Noise figure		14		dB	
Max I/P before overload		15		dBm	
Input impedance		1		k $\Omega$	1k $\Omega$ in parallel with 2pF
Output impedance		50		$\Omega$	

## NOTES

- Parameter guaranteed but not tested
- Tested at 25 $^{\circ}\text{C}$  only, but guaranteed at temperature
- Gain will typically increase by 6dB, when RF outputs use 1k $\Omega$  loads in place of 50 $\Omega$

## SL2524

### ELECTRICAL CHARACTERISTICS - SL2524C

Guaranteed at the following test conditions unless otherwise stated

Frequency = 200MHz,  $T_{amb} = +25^{\circ}\text{C}$ , Input power = -30dBm,  $V_{CC} = 6V \pm 0.1V$ , Source Impedance = 50 $\Omega$ .

Load impedance = 50 $\Omega$ , Test Circuit = Fig. 4,  $R_{SET} = 300\Omega$ . Tested as a dual stage.

Characteristic	Value			Units	Conditions
	Min	Typ	Max		
Supply current	70	87	100	mA	
Small signal gain (dual stage, single ended)	9.6	11.4	13.0	dB	$T_{amb} = +25^{\circ}\text{C}$ f = 25MHz See Note 3
	9.6	11.6	13.6	dB	$T_{amb} = -30^{\circ}\text{C}$ f = 200MHz See Notes 2, 3
	9.4	11.3	13.2	dB	$T_{amb} = +25^{\circ}\text{C}$ f = 200MHz See Note 3
	9.0	11.0	13.0	dB	$T_{amb} = +85^{\circ}\text{C}$ f = 200MHz See Notes 2, 3
	9.2	11.2	13.2	dB	$T_{amb} = -30^{\circ}\text{C}$ f = 500MHz See Notes 1, 3
	8.8	10.7	12.6	dB	$T_{amb} = +25^{\circ}\text{C}$ f = 500MHz See Note 1
	7.7	9.7	11.7	dB	$T_{amb} = +85^{\circ}\text{C}$ f = 500MHz See Notes 1, 3
Detected output current (max)	3.20	3.45	3.70	mA	$T_{amb} = +25^{\circ}\text{C}$ , $V_{IN} = 0\text{dBm}$ , f = 25MHz
	2.95	3.25	3.55	mA	$T_{amb} = -30^{\circ}\text{C}$ , $V_{IN} = 0\text{dBm}$ , f = 200MHz
					See Note 2
	3.05	3.30	3.55	mA	$T_{amb} = +25^{\circ}\text{C}$ , $V_{IN} = 0\text{dBm}$ , f = 200MHz
	3.00	3.30	3.50	mA	$T_{amb} = +85^{\circ}\text{C}$ , $V_{IN} = 0\text{dBm}$ , f = 200MHz
					See Note 2
	2.70	3.10	3.30	mA	$T_{amb} = -30^{\circ}\text{C}$ , $V_{IN} = 0\text{dBm}$ , f = 500MHz
					See Note 1
	2.80	3.15	3.55	mA	$T_{amb} = +25^{\circ}\text{C}$ , $V_{IN} = 0\text{dBm}$ , f = 500MHz
					See Note 1
	2.75	3.10	3.75	mA	$T_{amb} = +85^{\circ}\text{C}$ , $V_{IN} = 0\text{dBm}$ , f = 500MHz
					See Note 1
Detected output current (no signal)	0.75	0.95	1.25	mA	$T_{amb} = -30^{\circ}\text{C}$ , See Note 2
	0.70	0.93	1.20	mA	$T_{amb} = +25^{\circ}\text{C}$ , See Note 2
	0.70	0.90	1.20	mA	$T_{amb} = +85^{\circ}\text{C}$ , See Note 2
Upper cut off frequency (RF)		1000		MHz	-3dB w.r.t 200MHz, $T_{amb} = +25^{\circ}\text{C}$ See Note 1
Lower cut off frequency (RF)		0.35	2	MHz	-3dB w.r.t 200MHz, $T_{amb} = +25^{\circ}\text{C}$
Detector cut off frequency		600		MHz	50% O/P current w.r.t. 200MHz
Limited IF O/P voltage	105	135	175	mV	I/P power = 0dBm, $T_{amb} = +25^{\circ}\text{C}$
Phase variation with input level (normalised to -30dBm)		0 $\pm$ 2.0		Degree	Frequency = 70MHz, -55 to +3dBm See Note 1
		-4.0 $\pm$ 2.0		Degree	Frequency = 200MHz, -55 to +3dBm See Note 1
Limited O/P var with temp.		$\pm$ 12	$\pm$ 25	mV	See Note 1
Noise figure		14		dB	
Max I/P before overload		15		dBm	
Input impedance		1		k $\Omega$	1k $\Omega$ in parallel with 2pF
Output impedance		50		$\Omega$	

#### NOTES

1. Parameter guaranteed but not tested
2. Tested at 25 $^{\circ}\text{C}$  only, but guaranteed at temperature
3. Gain will typically increase by 6dB, when RF outputs use 1k $\Omega$  loads in place of 50 $\Omega$

**GENERAL DESCRIPTION**

The SL2524 is primarily intended for use in Radar and EW receivers. Six stages (3 chip carriers) can be cascaded to form a very wideband logarithmic amplifier offering >65dB of input dynamic range, with pulse handling of better than 25ns. (See figs 5 and 6.)

A six stage strip also offers balanced IF limiting, linearity (log accuracy) of <math>\pm 1.0\text{dB}</math>, temperature stabilisation and programmable detector characteristics.

The detector has an external resistor set ( $R_{SET}$ ) pin which allows the major characteristics of the detector to be programmed. With six stage strip it is possible to vary the value of  $R_{SET}$  on each detector and so improve the overall log error/linearity.

The detector is full wave and good slew rates are achieved with 2ns rise and 5ns fall times (no video filter). The video bandwidth of a six stage strip is typically 600MHz (-3dB).

The amplifier also offers balanced IF limiting, low phase shift versus input amplitude, and at an IF of 120MHz, less than  $5^\circ$  of phase change is achievable over the input level of -55dBm to +5dBm.

The IF and Video ports can be used simultaneously, so offering phase, frequency and pulse (video) information. A slight loss of dynamic range (2dB) will be observed when the IF ports are used in conjunction with the video.

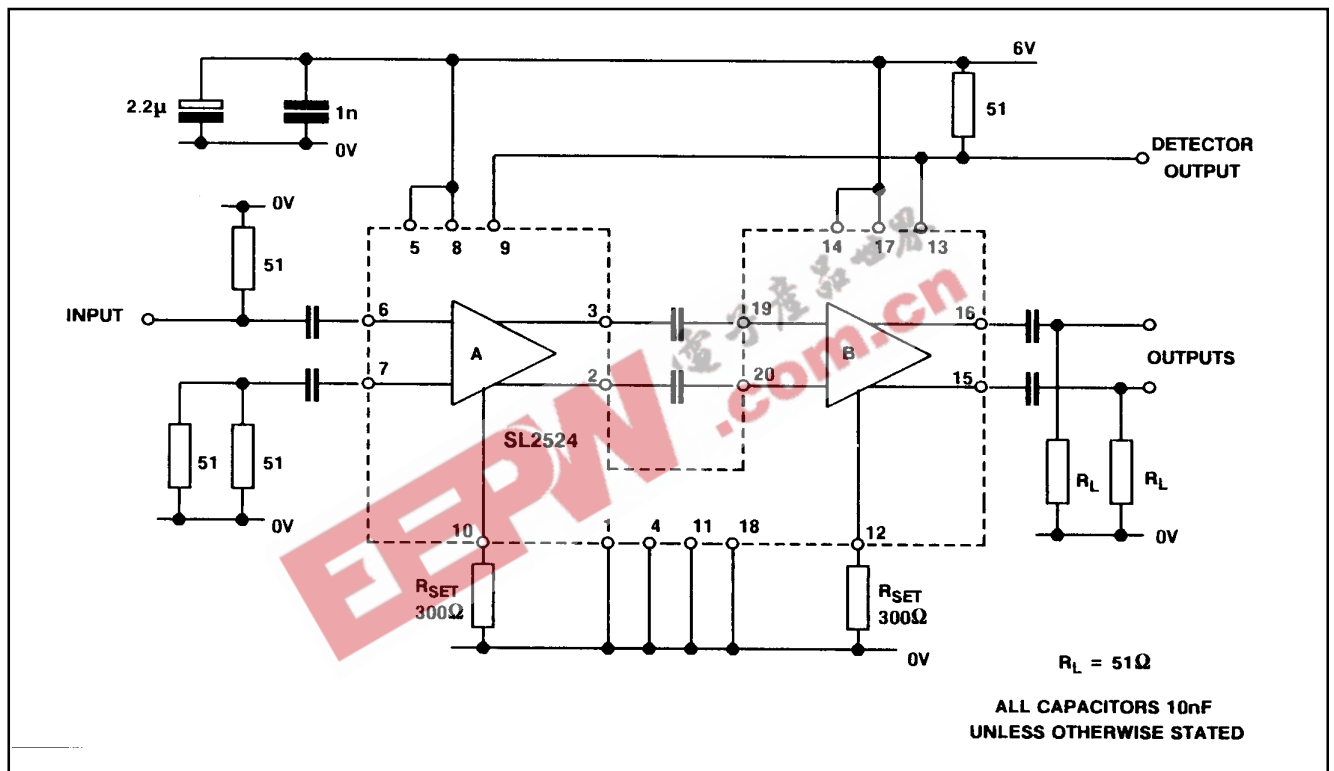

Fig.4 Test circuit

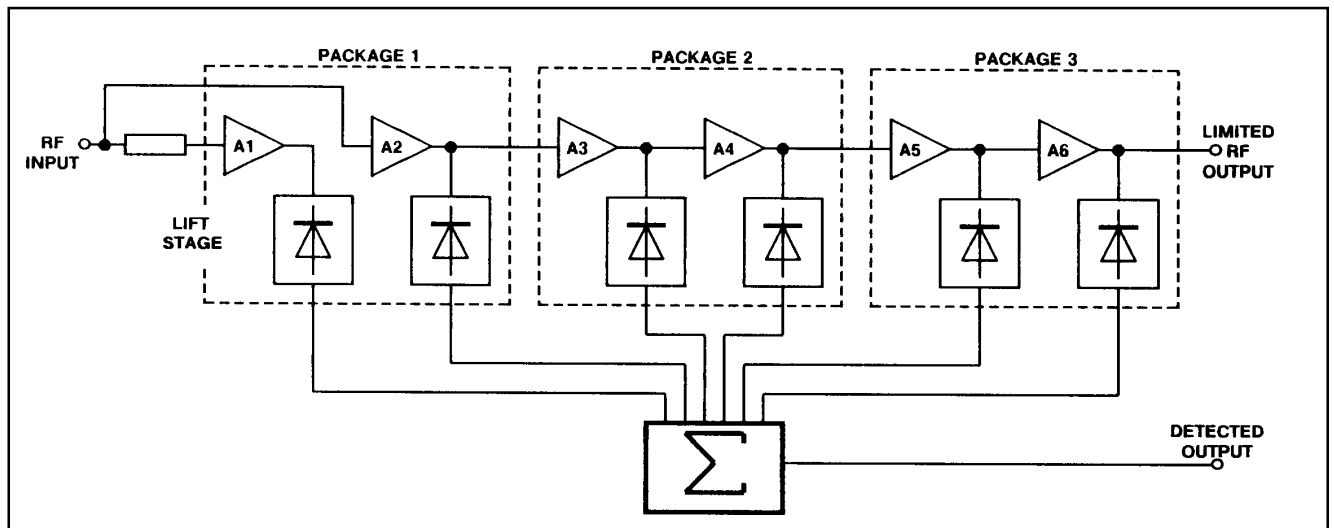

Fig.5 Schematic diagram showing configuration of SD Log strip

SL2524

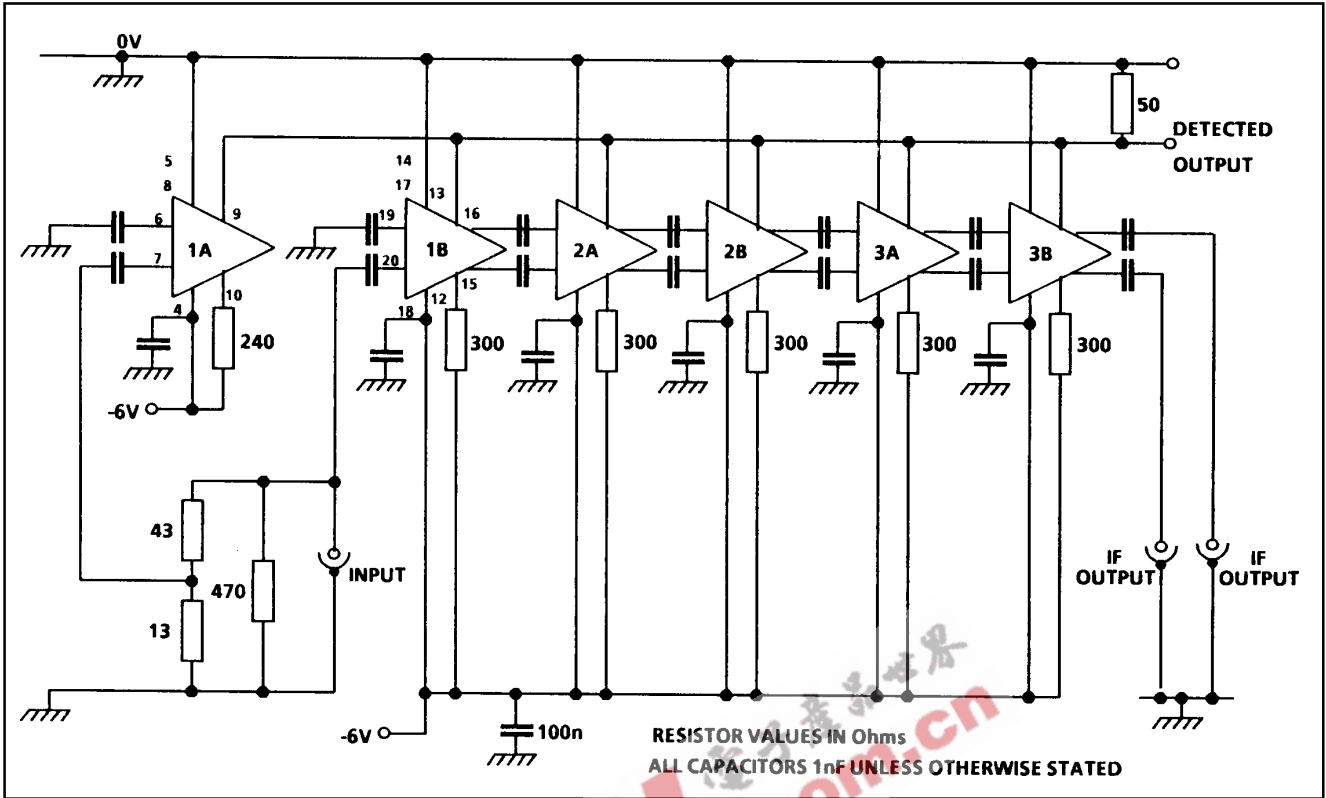

Fig.6 Circuit diagram for 6-log strip (results shown in figs. 11 to 24 were achieved with this circuit)

Typical characteristics for a dual - stage amplifier (i.e. One SL2524)

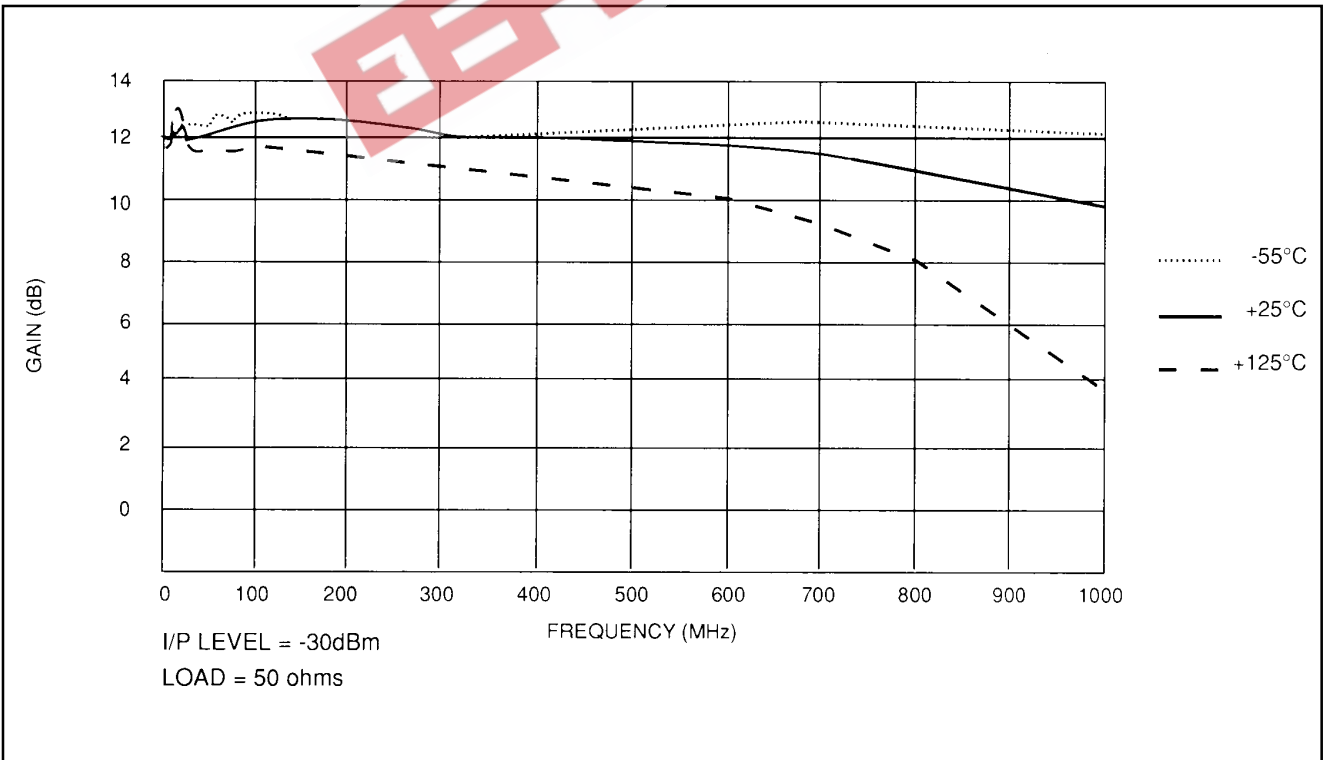

Fig.7 IF Gain vs frequency of 2 amplifiers (One SL2524)

Typical characteristics for a dual - stage amplifier (i.e. One SL2524) cont.

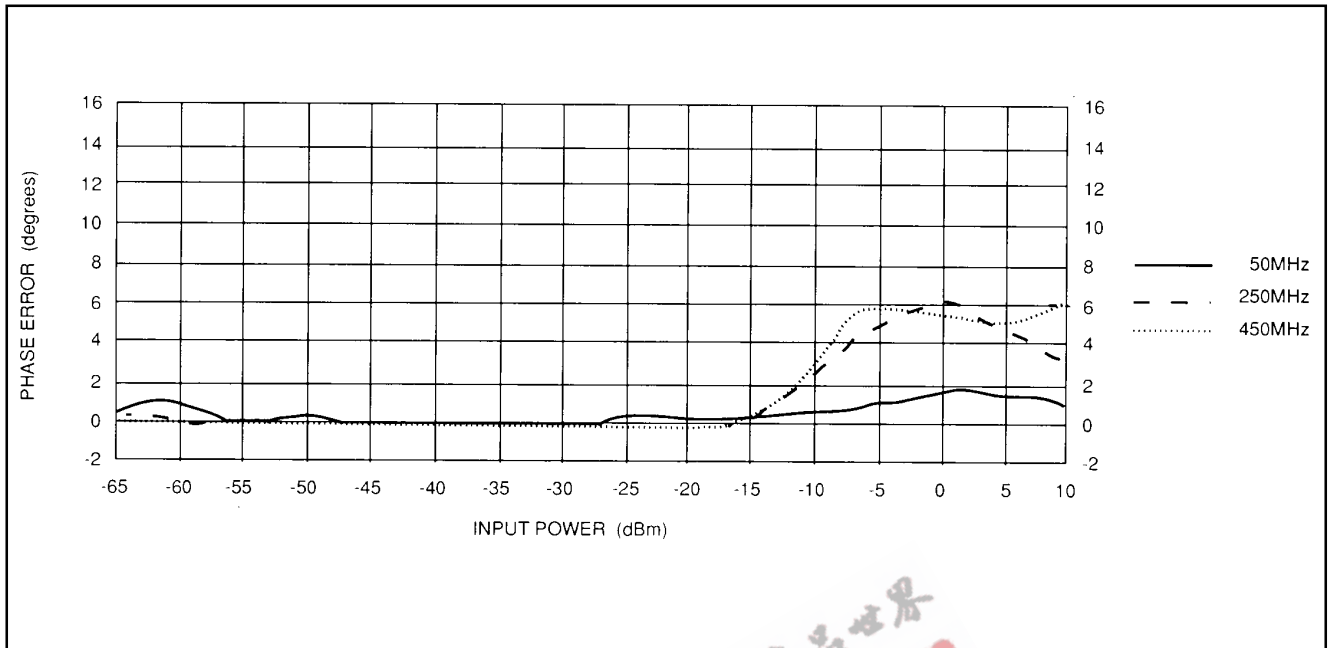

Fig.8 Normalised phase vs CW input level at 50, 250 and 450MHz for 50Ω O/P termination (25°C)

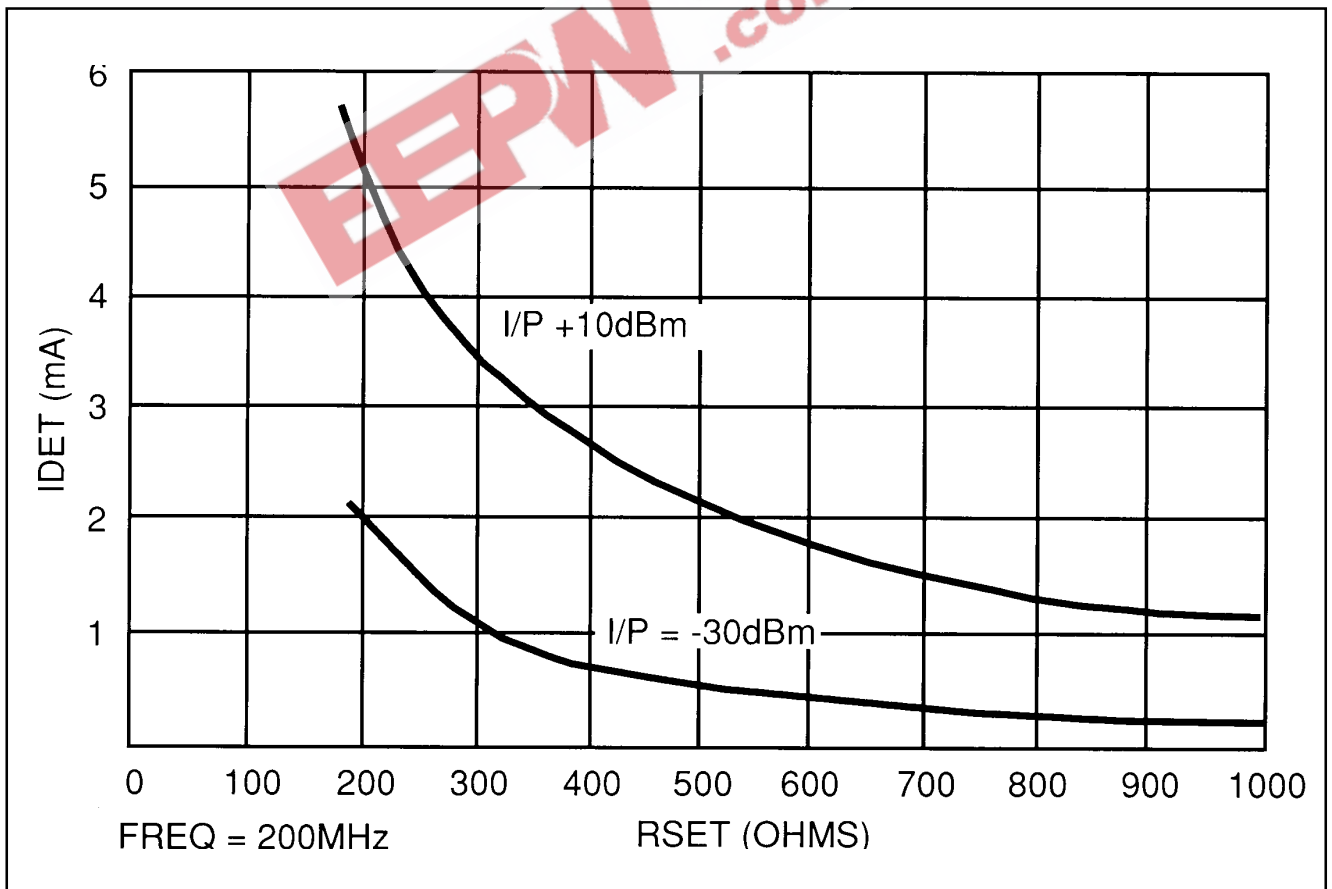

Fig.9 Detector current vs  $R_{SET}$  at 200MHz (25°C)

SL2524

Typical characteristics for a dual - stage amplifier (i.e. One SL2524) cont.

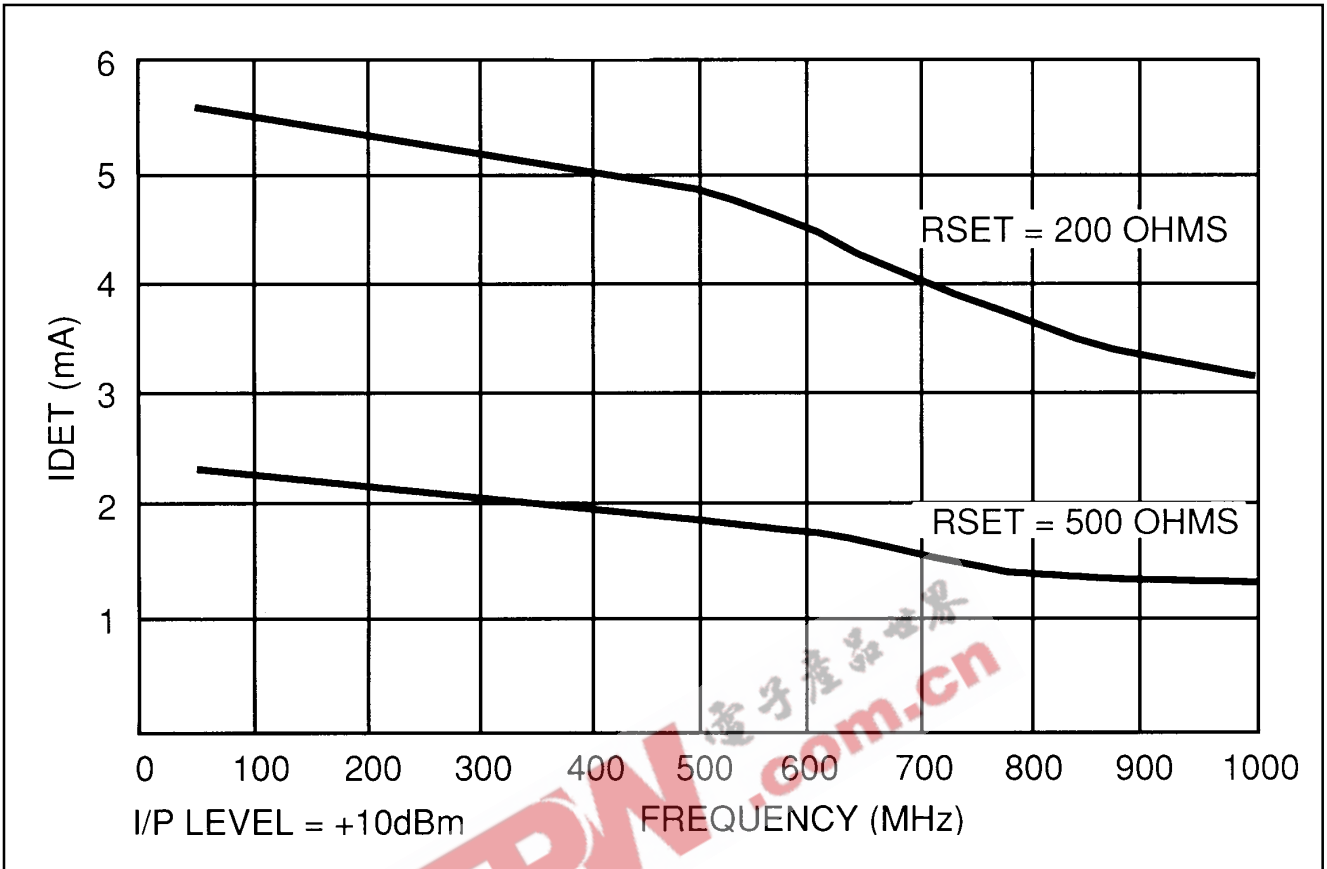

Fig.10 Detector current vs frequency at RSET = 200Ω and 500Ω (25°C)

Typical characteristics for a six stage strip, using detected output (Ref. figs 5 & 6)

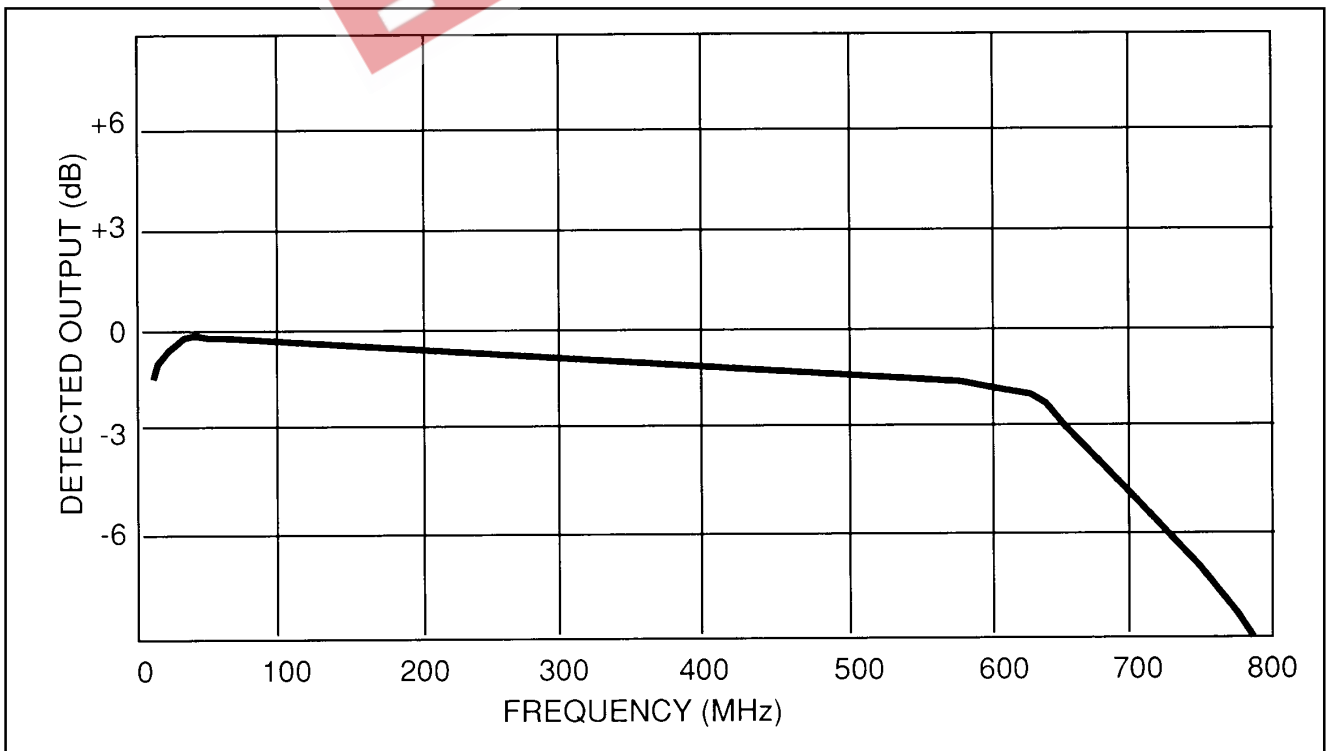

Fig.11 Detector bandwidth (25°C)



Typical characteristics for a six stage strip, using detected output (Ref. figs 5 & 6) cont.

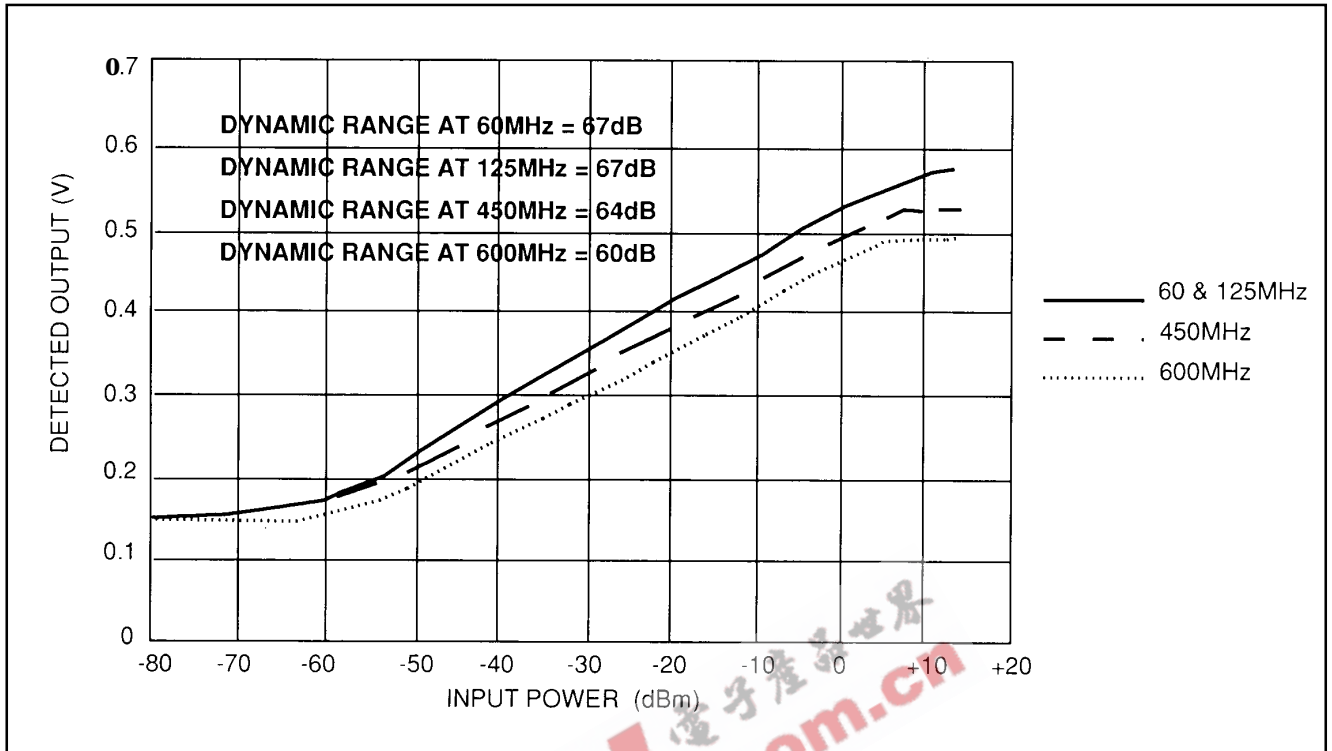

Fig.12 Detected O/P vs CW input at 60, 125, 450 and 600MHz at 25°C

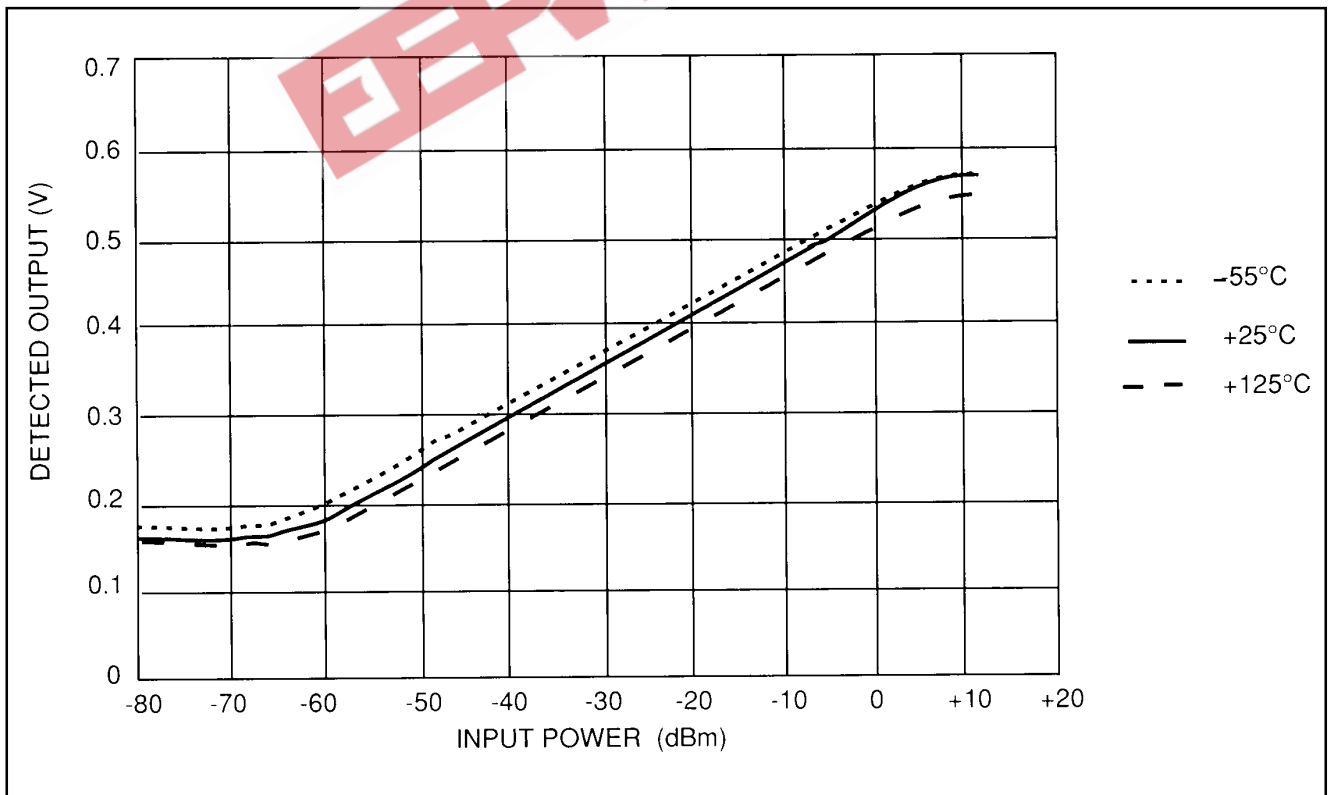

Fig.13 Detected O/P vs CW input level and temperature at 60 and 125MHz

SL2524

Typical characteristics for a six stage strip, using detected output (Ref. figs 5 & 6) cont.

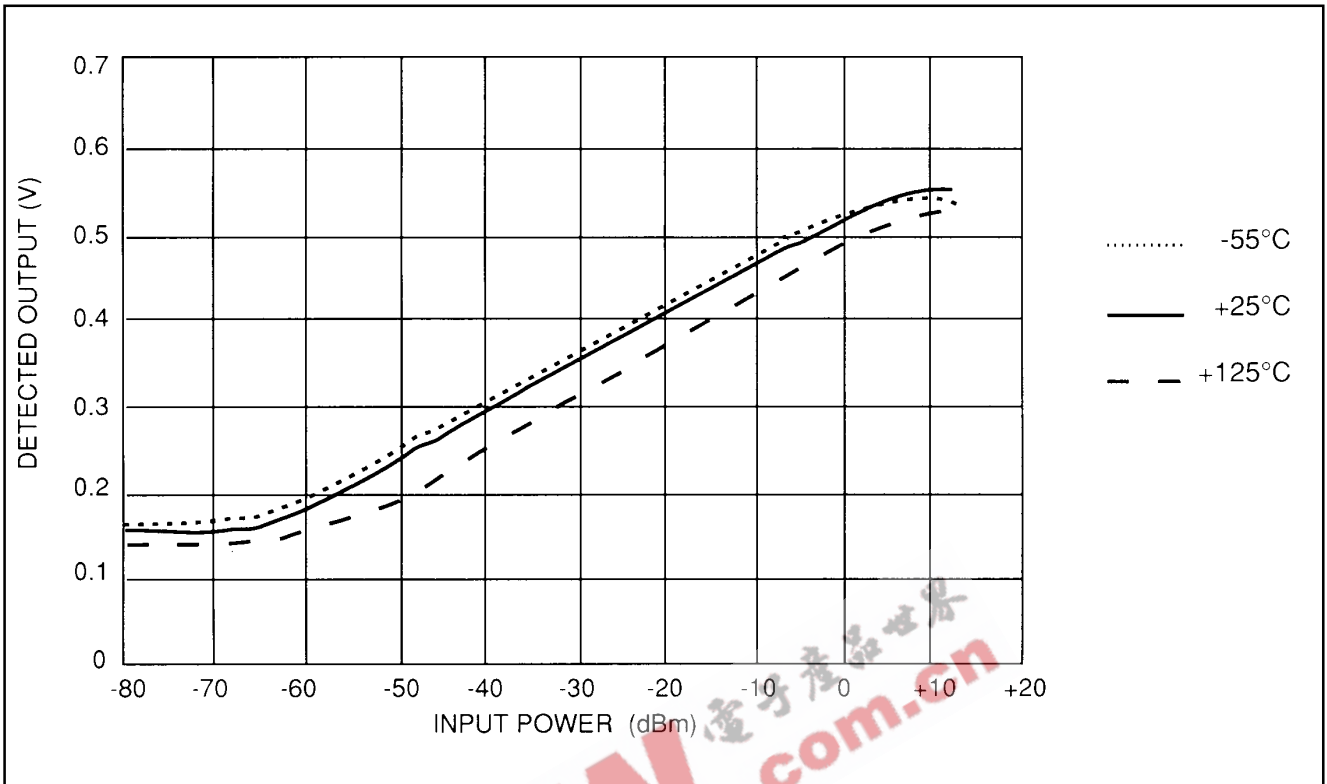

Fig.14 Detected O/P vs CW input level at 450MHz across temperature

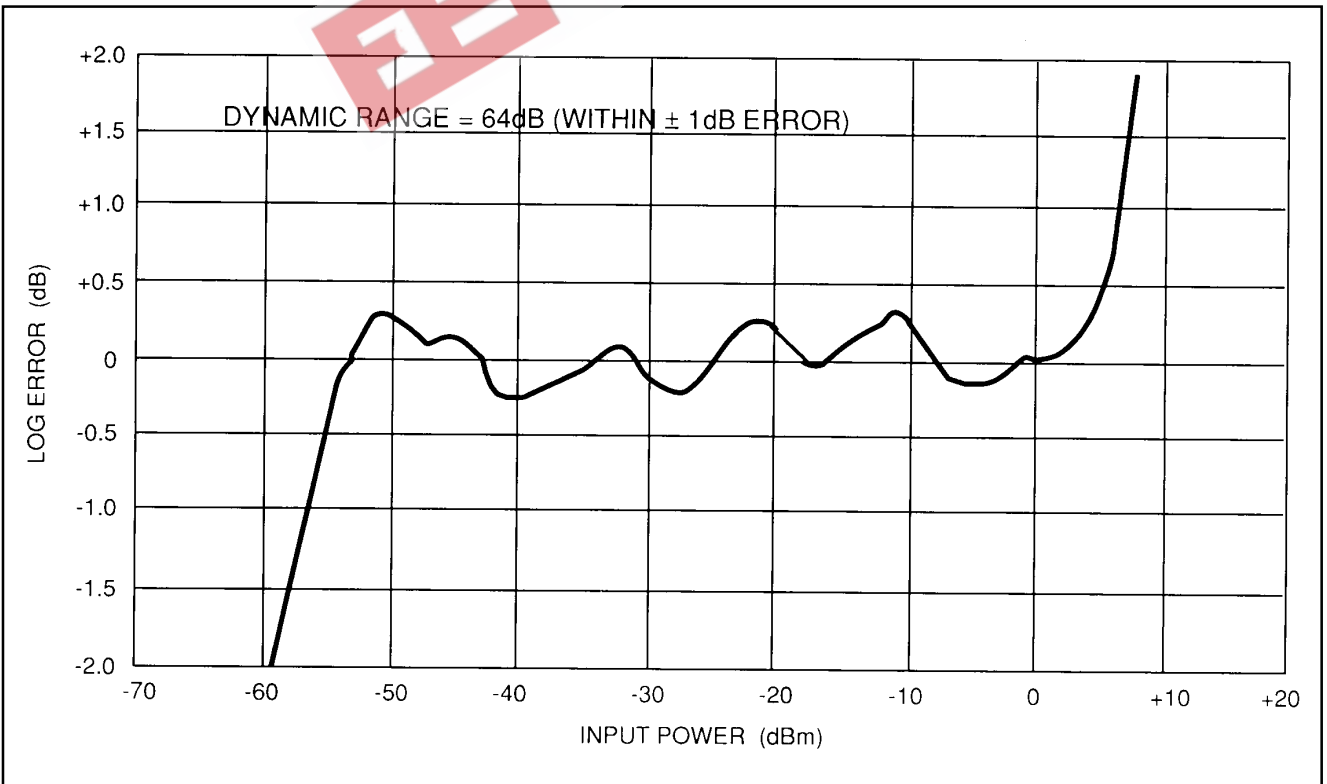

Fig.15 Typical log linearity of detected output measured at 450MHz (25°C)

Typical characteristics for a six stage strip as a low phase shift wideband limiter (Ref. figs 5 & 6)

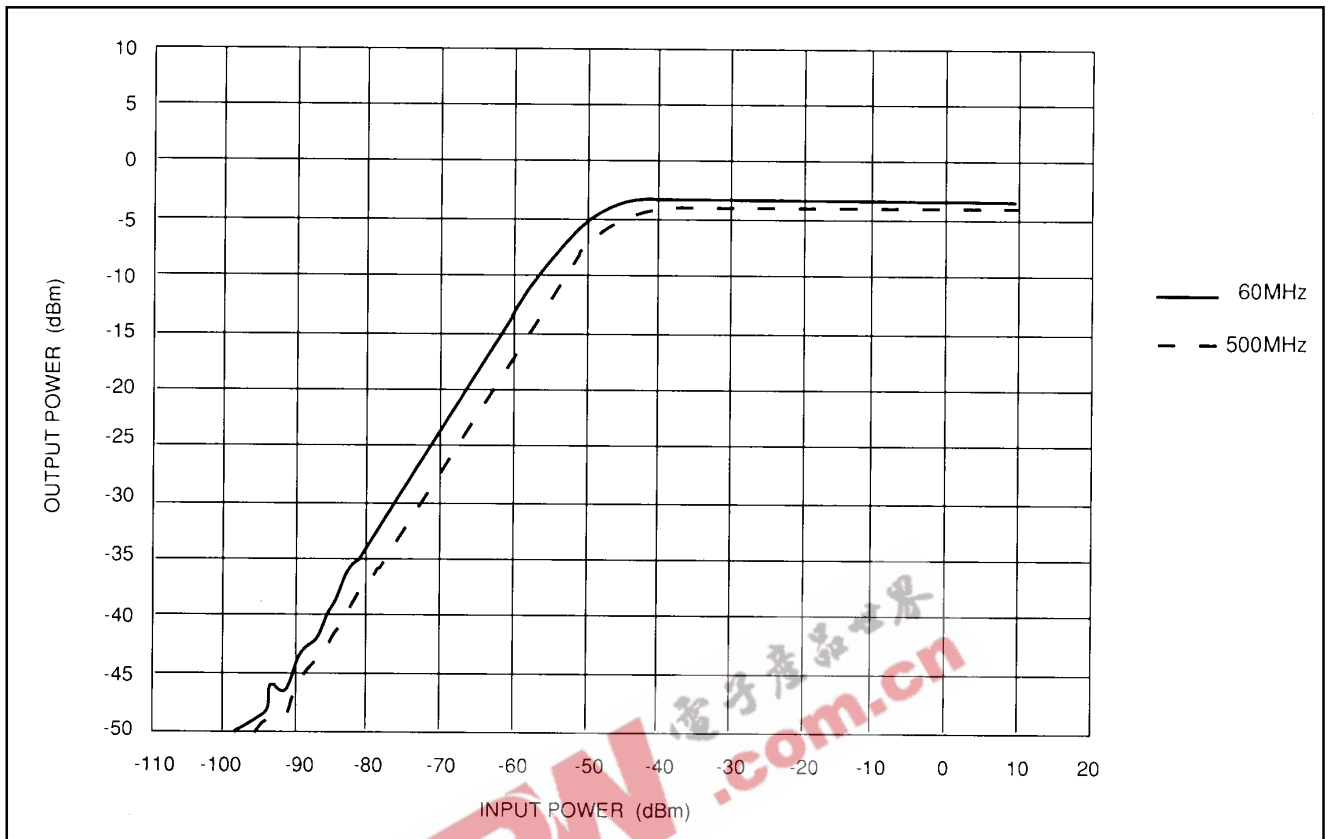

Fig.16 IF limiting characteristics at 60MHz and 500MHz (25°C)

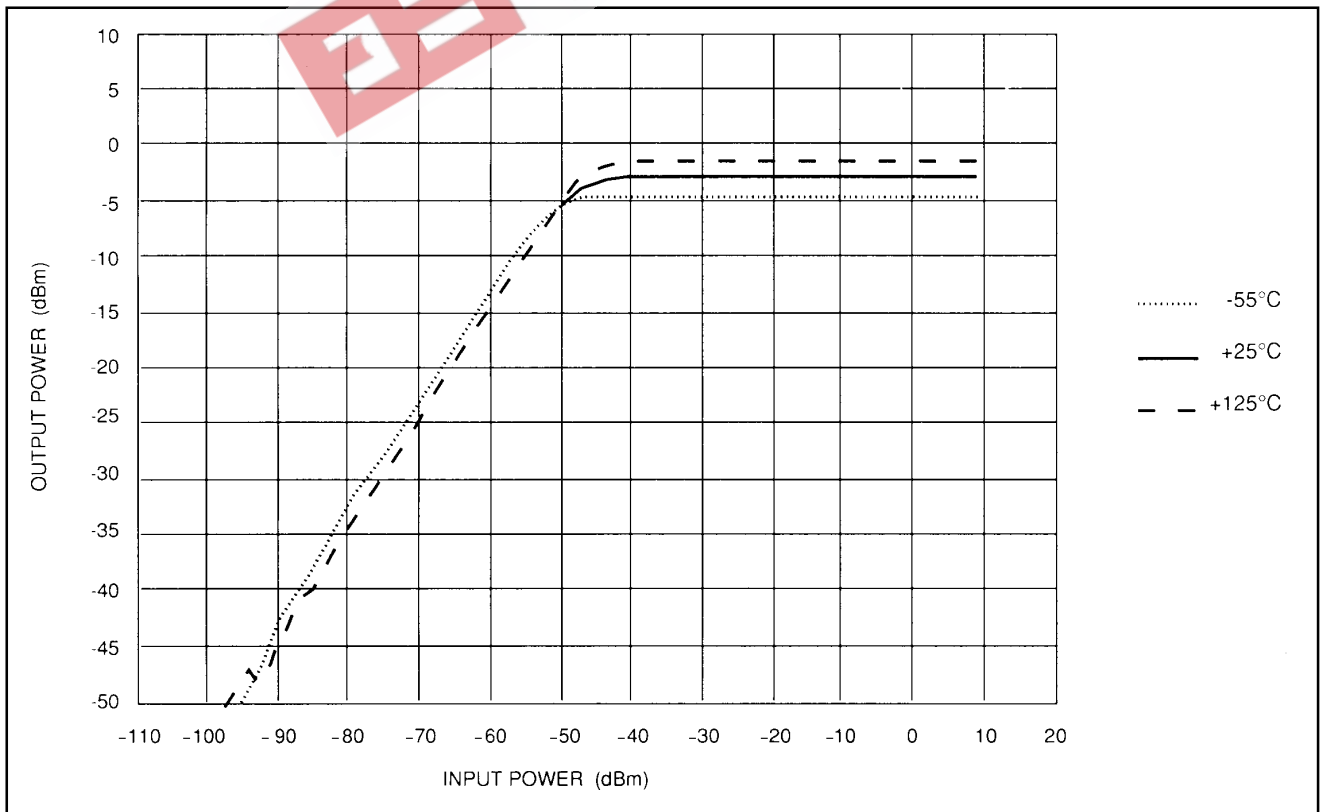

Fig.17 IF limiting characteristic at 60MHz across temperature

SL2524

Typical characteristics for a six stage strip as a low phase shift wideband limiter (Ref. figs 5 & 6)

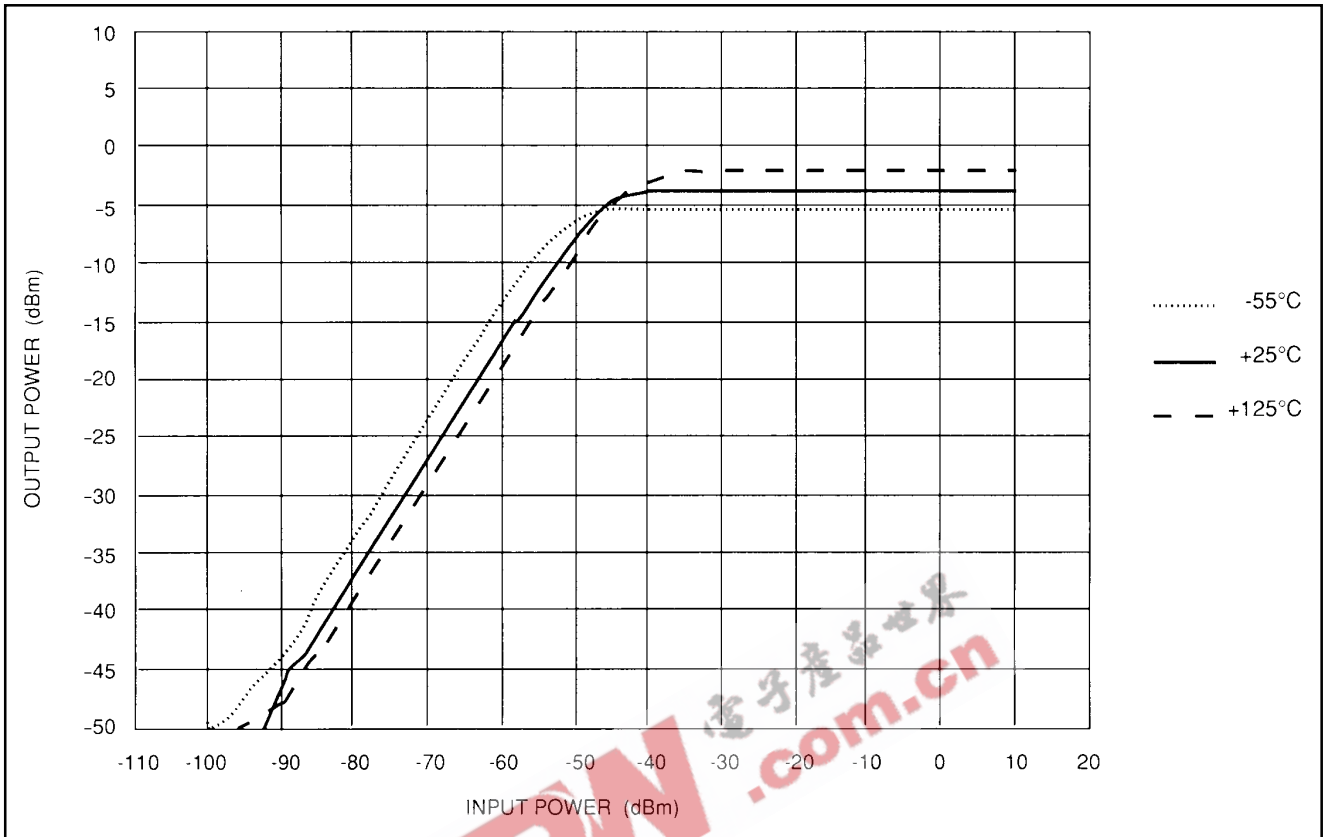

Fig.18 IF limiting characteristic at 500MHz across temperature

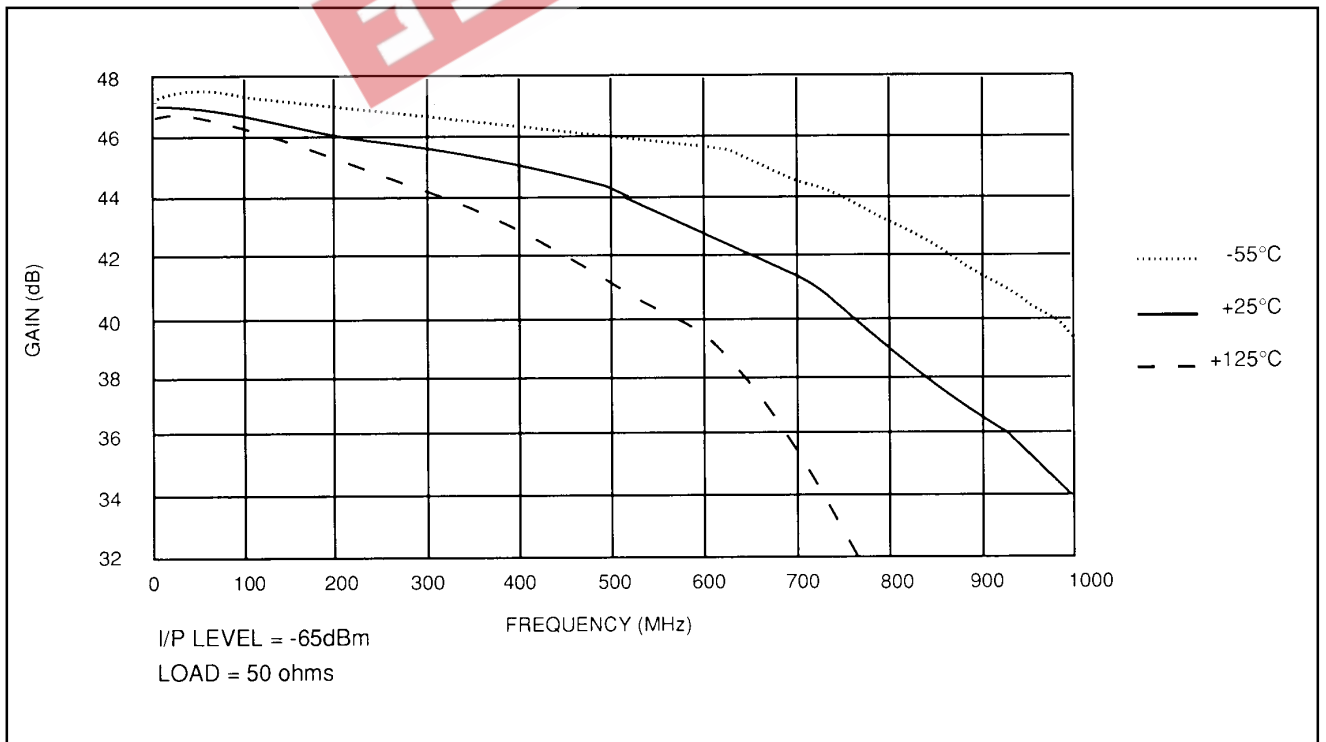

Fig.19 Small signal gain vs frequency across temperature

Typical characteristics for a six stage strip as a low phase shift wideband limiter (Ref. figs 5 & 6)

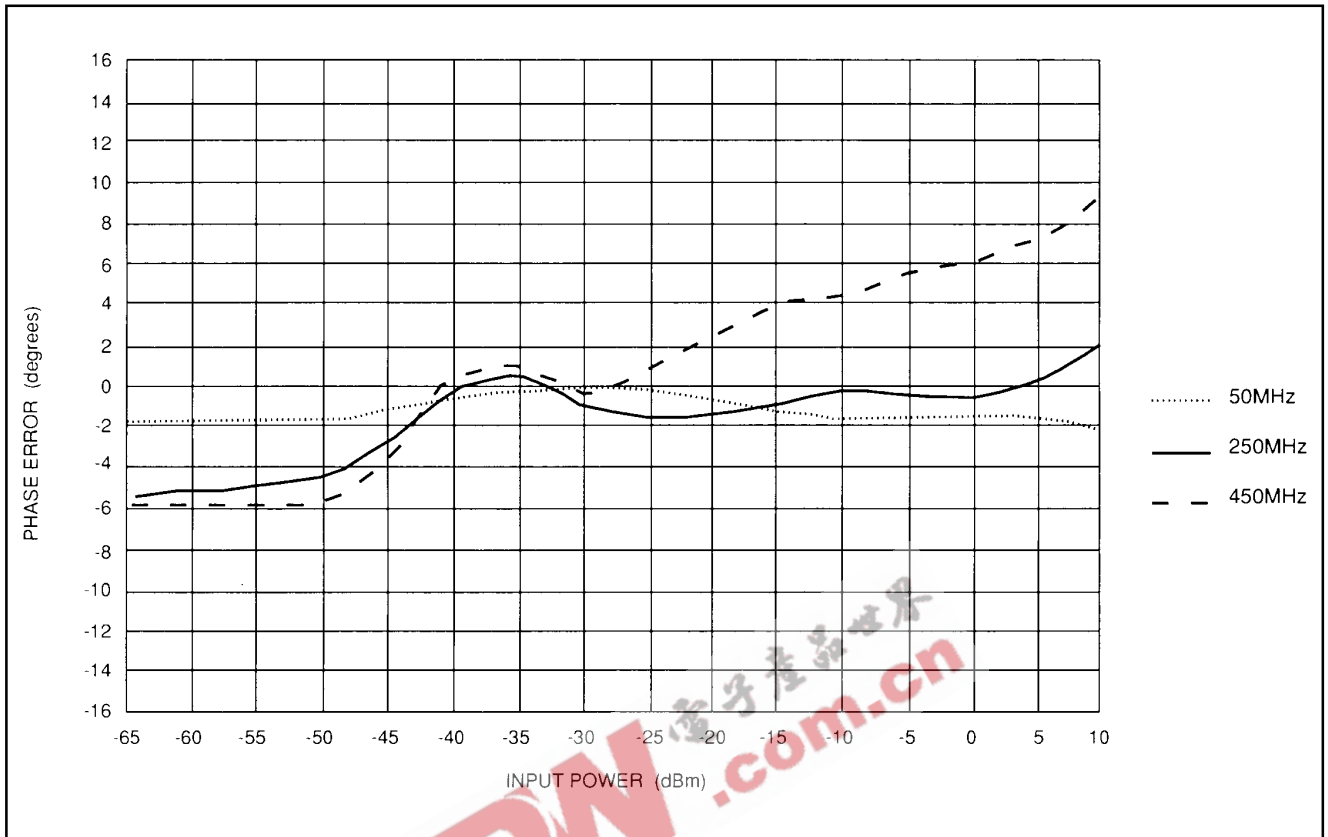

Fig.20 Phase deviation vs CW input level (normalised at -30dBm) at 25°C across input frequency

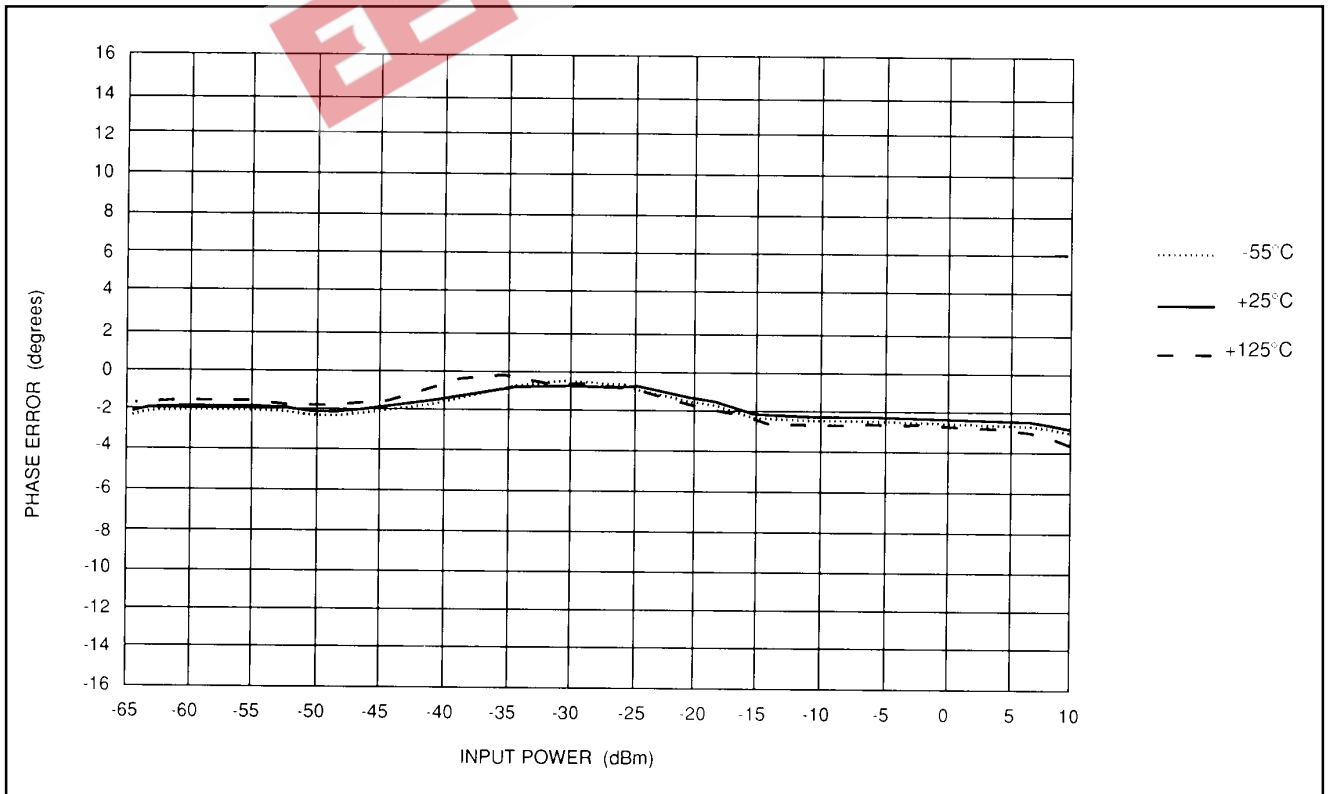

Fig.21 Phase deviation vs CW input level (normalised at -30dBm) at 50MHz across temperature

SL2524

Typical characteristics for a six stage strip as a low phase shift wideband limiter (Ref. figs 5 & 6)

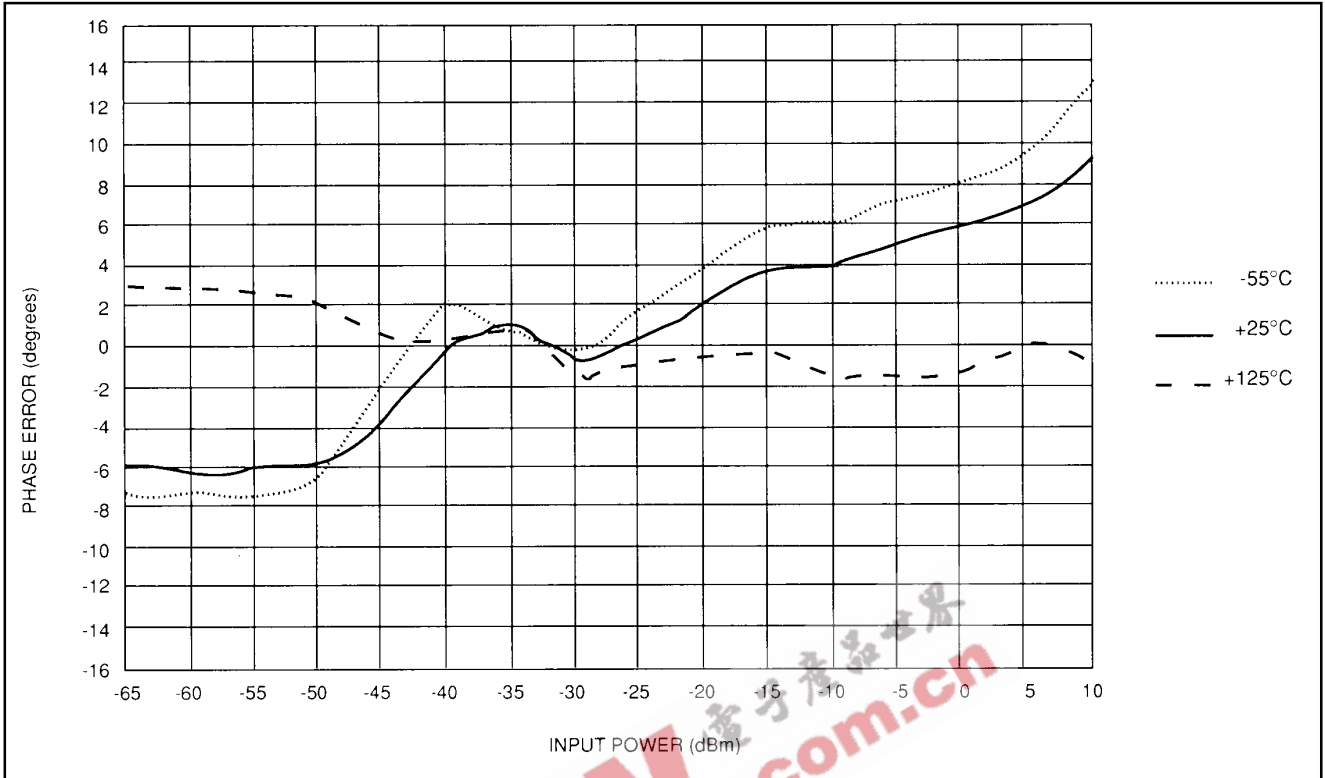

Fig.22 Phase deviation vs CW input level (normalised at -30dBm) at 450MHz across temperature

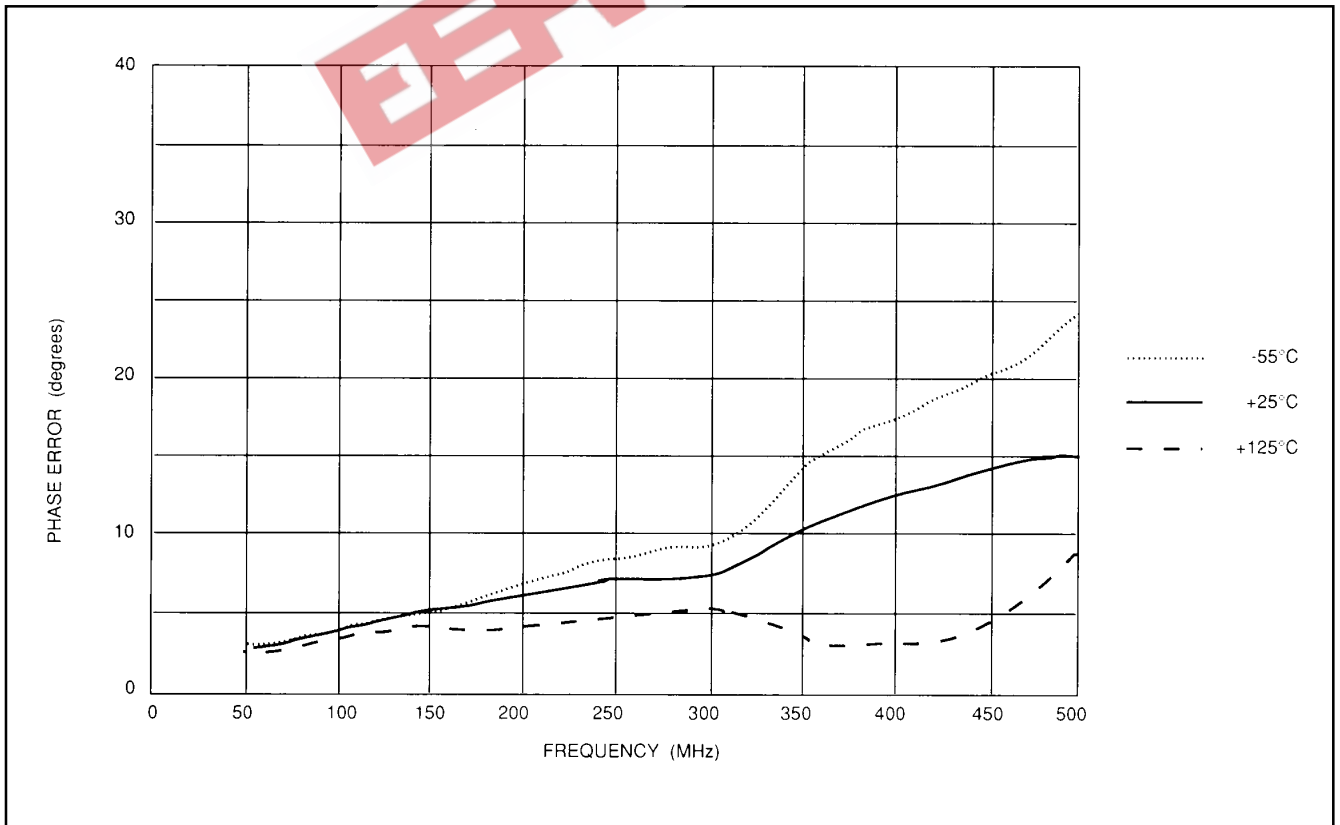

Fig.23 Peak phase deviation over -65dBm → +10dBm CW input level vs CW input frequency. Across temperature

EEPW 电子产品世界  
.com.cn



**For more information about all Zarlink products  
visit our Web Site at**

**[www.zarlink.com](http://www.zarlink.com)**

Information relating to products and services furnished herein by Zarlink Semiconductor Inc. or its subsidiaries (collectively "Zarlink") is believed to be reliable. However, Zarlink assumes no liability for errors that may appear in this publication, or for liability otherwise arising from the application or use of any such information, product or service or for any infringement of patents or other intellectual property rights owned by third parties which may result from such application or use. Neither the supply of such information or purchase of product or service conveys any license, either express or implied, under patents or other intellectual property rights owned by Zarlink or licensed from third parties by Zarlink, whatsoever. Purchasers of products are also hereby notified that the use of product in certain ways or in combination with Zarlink, or non-Zarlink furnished goods or services may infringe patents or other intellectual property rights owned by Zarlink.

This publication is issued to provide information only and (unless agreed by Zarlink in writing) may not be used, applied or reproduced for any purpose nor form part of any order or contract nor to be regarded as a representation relating to the products or services concerned. The products, their specifications, services and other information appearing in this publication are subject to change by Zarlink without notice. No warranty or guarantee express or implied is made regarding the capability, performance or suitability of any product or service. Information concerning possible methods of use is provided as a guide only and does not constitute any guarantee that such methods of use will be satisfactory in a specific piece of equipment. It is the user's responsibility to fully determine the performance and suitability of any equipment using such information and to ensure that any publication or data used is up to date and has not been superseded. Manufacturing does not necessarily include testing of all functions or parameters. These products are not suitable for use in any medical products whose failure to perform may result in significant injury or death to the user. All products and materials are sold and services provided subject to Zarlink's conditions of sale which are available on request.

Purchase of Zarlink's I<sup>2</sup>C components conveys a licence under the Philips I<sup>2</sup>C Patent rights to use these components in and I<sup>2</sup>C System, provided that the system conforms to the I<sup>2</sup>C Standard Specification as defined by Philips.

Zarlink, ZL and the Zarlink Semiconductor logo are trademarks of Zarlink Semiconductor Inc.

Copyright Zarlink Semiconductor Inc. All Rights Reserved.

**TECHNICAL DOCUMENTATION - NOT FOR RESALE**

---