

# C&K RTBV Series 1-2 Pole Coded Rotary Switches



## Features/Benefits

- **Totally sealed**
- **Detent angles, 15 , 22.5 , 30 and 36**
- **Multi pole**
- **Coding functions**
- **Robust construction**

## Typical Applications

- **Telecommunications**
- **Military**
- **Instrumentation**
- **Heavy-duty industrial equipment**

## Specifications

CONTACT RATING: S Contact material: Switch: 250mA, 5VA resistive load, Carry: 5 AMPS  
 ELECTRICAL LIFE: Up to 25,000 operations.  
 OPERATING TORQUE: 5Ncm±30% (with 1 module).  
 MECHANICAL STOP RESISTANCE: > 70 Ncm.  
 BUSHING MOUNTING TORQUE: 100 Ncm.  
 CONTACT RESISTANCE: < 100 m Ω.  
 INSULATION RESISTANCE: > 10<sup>9</sup> Ω  
 DIELECTRIC STRENGTH: 500 V rms.

**NOTE:** For the latest information regarding RoHS compliance, please go to: [www.ittcannon.com/rohs](http://www.ittcannon.com/rohs).

**NOTE:** Specifications and materials listed above are for switches with standard options. For information on specific and custom switches, consult Customer Service Center.

## Materials

HOUSING: PBT thermoplastic and PC thermoplastic  
 STATIONARY CONTACTS & TERMINALS: Nickel alloy, gold or silver plated, insert molded in PBT thermoplastic.  
 ROTOR: Printed circuit, gold or silver plated.  
 ACTUATOR: Steel  
 BUSHING: Brass  
 HARDWARE: Stop pin and spring: Stainless steel  
 All models are RoHS compliant and compatible.

## Build-A-Switch

To order, simply select desired option from each category and place in the appropriate box. Available options are shown and described on pages L-33 thru L-37. For additional options not shown in catalog, consult Customer Service Center.

Rotary

**Designation**  
RTBV

**Indexing**

15 15°  
22.5 22.5°  
30 30°  
36 36°

**Switch Function**

**Number of Poles (first digit)**  
**Number of Positions (second & third digit) or code**

116 SP, 16 positions  
112 SP, 12 positions  
206 DP, 6 positions  
B Binary code  
C Complement  
BC Direct + complement

**Number of Switch Functions\*\***

1 1 Function  
2 2 Functions

**Stops**

B Stop with number of positions  
S Without

**Mounting Style**

AD Standard bushing for panel mount  
DE Sealed bushing for panel mount

**Shaft Diameter**

D6 6 mm (.236)  
D63 6.35 mm (.250)

**Option of Shaft (NONE)**

M10X5 Shaft with flat

**Actuator Option Angle\* (NONE)**

K0 0° angle  
K60 60° angle  
K90 90° angle  
K120 120° angle  
K180 180° angle  
K270 270° angle

**Actuator Length**

25 25 mm (.984)

**Contact Material**

S Silver plated  
G Gold plated

\* Other angles available by request  
 \*\* Several functions can be combined. For more information consult us.



Dimensions are shown: Inch (mm)  
 Specifications and dimensions subject to change

# C&K RTBV Series 1-2 Pole Coded Rotary Switches

DESIGNATION



RTBV

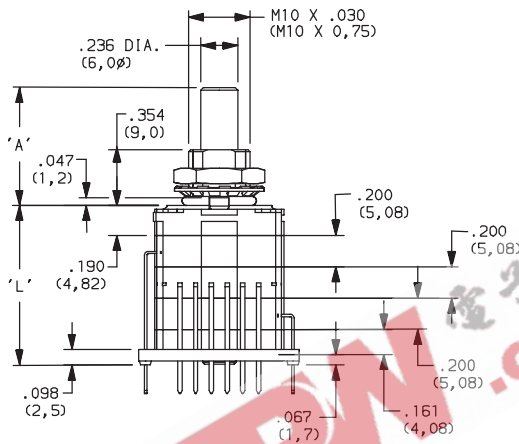
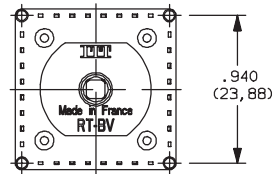

INDEXING



**15** 15° index, 24 POSITIONS MAXIMUM

**22.5** 22.5° index, 16 POSITIONS MAXIMUM

**30** 30° index, 12 POSITIONS MAXIMUM

**36** 36° index, 10 POSITIONS MAXIMUM



Dimensions are shown: Inch (mm)  
Specifications and dimensions subject to change

# C&K RTBV Series 1-2 Pole Coded Rotary Switches

## NUMBER OF SWITCH FUNCTIONS



- 1** 1 FUNCTION
- 2** 2 FUNCTIONS

**NOTE:** Several functions can be combined. For more information consult us.

## NUMBER OF POLES / POSITIONS



- 116** 22.5 INDEX, SP, 16 POSITIONS
- 112** 30 INDEX, SP, 12 POSITIONS
- 206** 30 INDEX, DP, 6 POSITIONS
- B** BINARY CODE, 15 /22.5 /30 /36
- C** COMPLEMENT, 15 /22.5 /30 /36
- BC** DIRECT + COMPLEMENT, 15 /22.5 /30 /36

SINGLE POLE FUNCTION

	C	1	2	3	4	5	6	7	8	9	10	11	12	13	14	15	16	17	18	19	20	21	22	23	24	
1	●	●																								
2	●		●																							
3	●			●																						
4	●				●																					
5	●					●																				
6	●						●																			
7	●							●																		
8	●								●																	
9	●									●																
10	●										●															
11	●											●														
12	●												●													
13	●													●												
14	●														●											
15	●															●										
16	●																●									
17	●																	●								
18	●																		●							
19	●																			●						
20	●																				●					
21	●																					●				
22	●																						●			
23	●																							●		
24	●																								●	



Rotary

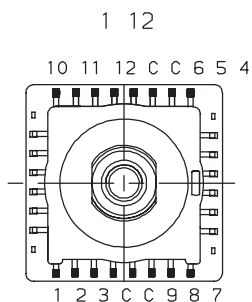

Dimensions are shown: Inch (mm)  
Specifications and dimensions subject to change

# C&K RTBV Series 1-2 Pole Coded Rotary Switches

## NUMBER OF POLES / POSITIONS



### DOUBLE POLE FUNCTION

	C <sub>1</sub>	1 <sub>1</sub>	2 <sub>1</sub>	3 <sub>1</sub>	4 <sub>1</sub>	5 <sub>1</sub>	6 <sub>1</sub>	C <sub>2</sub>	1 <sub>2</sub>	2 <sub>2</sub>	3 <sub>2</sub>	4 <sub>2</sub>	5 <sub>2</sub>	6 <sub>2</sub>
1	●	●						●	●					
2	●		●					●		●				
3	●			●				●			●			
4	●				●			●				●		
5	●					●		●					●	
6	●						●	●						●



### BINARY DIRECT CODE

	C	1	2	4	8	16
0	●	●	●	●	●	●
1	●	●	●	●	●	●
2	●	●	●	●	●	●
3	●	●	●	●	●	●
4	●	●	●	●	●	●
5	●	●	●	●	●	●
6	●	●	●	●	●	●
7	●	●	●	●	●	●
8	●	●	●	●	●	●
9	●	●	●	●	●	●
10	●	●	●	●	●	●
11	●	●	●	●	●	●
12	●	●	●	●	●	●
13	●	●	●	●	●	●
14	●	●	●	●	●	●
15	●	●	●	●	●	●
16	●	●	●	●	●	●
17	●	●	●	●	●	●
18	●	●	●	●	●	●
19	●	●	●	●	●	●
20	●	●	●	●	●	●
21	●	●	●	●	●	●
22	●	●	●	●	●	●
23	●	●	●	●	●	●

B10 B12 B16

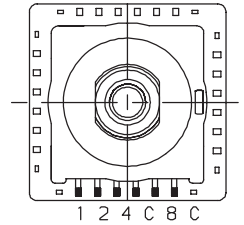

B24

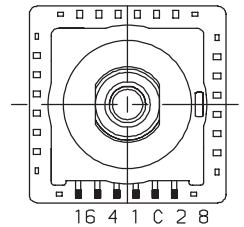

### COMPLEMENT BINARY CODE

	C	1	2	4	8	16
0	●	●	●	●	●	●
1	●	●	●	●	●	●
2	●	●	●	●	●	●
3	●	●	●	●	●	●
4	●	●	●	●	●	●
5	●	●	●	●	●	●
6	●	●	●	●	●	●
7	●	●	●	●	●	●
8	●	●	●	●	●	●
9	●	●	●	●	●	●
10	●	●	●	●	●	●
11	●	●	●	●	●	●
12	●	●	●	●	●	●
13	●	●	●	●	●	●
14	●	●	●	●	●	●
15	●	●	●	●	●	●
16	●	●	●	●	●	●
17	●	●	●	●	●	●
18	●	●	●	●	●	●
19	●	●	●	●	●	●
20	●	●	●	●	●	●
21	●	●	●	●	●	●
22	●	●	●	●	●	●
23	●	●	●	●	●	●

C10 C12 C16



C24



### DIRECT AND COMPLEMENT BINARY CODE

	C	1	2	4	8	16	C	1	2	4	8	16
0	●	●	●	●	●	●	●	●	●	●	●	●
1	●	●	●	●	●	●	●	●	●	●	●	●
2	●	●	●	●	●	●	●	●	●	●	●	●
3	●	●	●	●	●	●	●	●	●	●	●	●
4	●	●	●	●	●	●	●	●	●	●	●	●
5	●	●	●	●	●	●	●	●	●	●	●	●
6	●	●	●	●	●	●	●	●	●	●	●	●
7	●	●	●	●	●	●	●	●	●	●	●	●
8	●	●	●	●	●	●	●	●	●	●	●	●
9	●	●	●	●	●	●	●	●	●	●	●	●
10	●	●	●	●	●	●	●	●	●	●	●	●
11	●	●	●	●	●	●	●	●	●	●	●	●
12	●	●	●	●	●	●	●	●	●	●	●	●
13	●	●	●	●	●	●	●	●	●	●	●	●
14	●	●	●	●	●	●	●	●	●	●	●	●
15	●	●	●	●	●	●	●	●	●	●	●	●
16	●	●	●	●	●	●	●	●	●	●	●	●
17	●	●	●	●	●	●	●	●	●	●	●	●
18	●	●	●	●	●	●	●	●	●	●	●	●
19	●	●	●	●	●	●	●	●	●	●	●	●
20	●	●	●	●	●	●	●	●	●	●	●	●
21	●	●	●	●	●	●	●	●	●	●	●	●
22	●	●	●	●	●	●	●	●	●	●	●	●
23	●	●	●	●	●	●	●	●	●	●	●	●

BC10 BC12 BC16

C 8 C 4 2 1

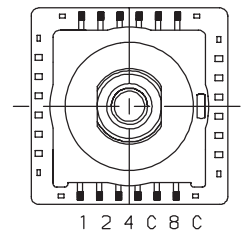

BC24

8 2 C 1 4 16

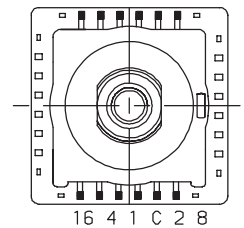

Third Angle Projection

Dimensions are shown: Inch (mm)  
Specifications and dimensions subject to change



# C&K RTBV Series 1-2 Pole Coded Rotary Switches

## STOPS

**B** STOP WITH NUMBER OF POSITIONS

**S** WITHOUT

EXAMPLE: 108B08 STOP AT 8TH POSITION

## MOUNTING STYLE

**AD** STANDARD BUSHING FOR PANEL MOUNT



**DE** SEALED BUSHING FOR PANEL MOUNT

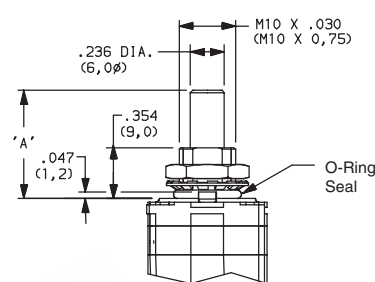

## SHAFT DIAMETER

**D6** 6 mm (.236)

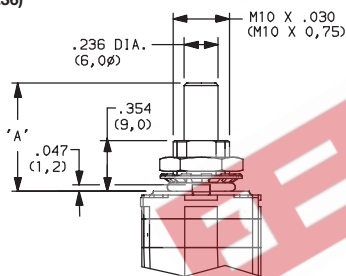

**D63** 6.35 mm (.250)

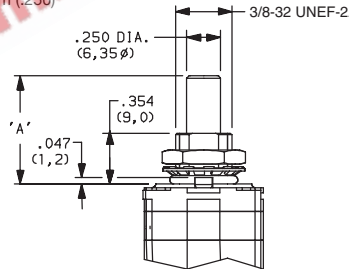

## OPTION OF SHAFT

**(NONE)**

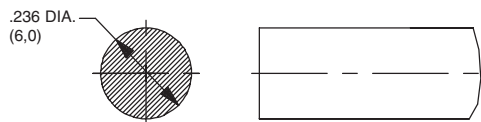

**M10X5** FLAT



Rotary

# C&K RTBV Series 1-2 Pole Coded Rotary Switches

## ACTUATOR OPTION ANGLE



(NONE)



**K0** 0 ANGLE

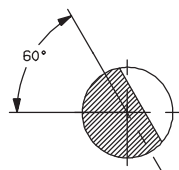

**K60** 60°

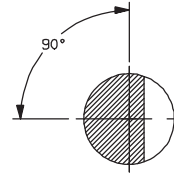

**K90** 90°



**K120** 120°



**K180** 210°



**K270** 300°



**K0** 0 ANGLE



**K60** 60°

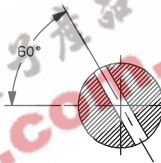

**K90** 90°

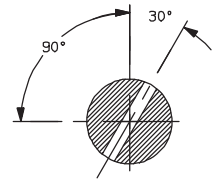

**K120** 120°

## ACTUATOR LENGTH



**25** 0,25 mm (.984) STANDARD SHAFT

Other lengths available by request.

## CONTACT MATERIAL



OPTION CODE	RoHS COMPLIANT*	RoHS COMPATIBLE*	CONTACT AND TERMINAL MATERIAL	RATING	
				LOW LEVEL/DRY CIRCUIT	SWITCH: 250 mA, POWER: 5 VA; CARRY: 5 AMPS
<b>S</b>	YES	YES	SILVER	LOW LEVEL/DRY CIRCUIT	SWITCH: 250 mA, POWER: 5 VA; CARRY: 5 AMPS
<b>G</b>	YES	YES	GOLD	LOW LEVEL/DRY CIRCUIT OR POWER	SWITCH: 20 mA, POWER: 0.2 VA; CARRY: 1 AMP

\* Note: See Technical Data section of this catalog for RoHS compliant and compatible definition and specifications.



Dimensions are shown: Inch (mm)  
Specifications and dimensions subject to change