

C&K RTBV Series 1-2 Pole Coded Rotary Switches



Features/Benefits

- **Totally sealed**
- **Detent angles, 15 , 22.5 , 30 and 36**
- **Multi pole**
- **Coding functions**
- **Robust construction**

Typical Applications

- **Telecommunications**
- **Military**
- **Instrumentation**
- **Heavy-duty industrial equipment**

Specifications

CONTACT RATING: S Contact material: Switch: 250mA, 5VA resistive load, Carry: 5 AMPS
 ELECTRICAL LIFE: Up to 25,000 operations.
 OPERATING TORQUE: 5Ncm±30% (with 1 module).
 MECHANICAL STOP RESISTANCE: > 70 Ncm.
 BUSHING MOUNTING TORQUE: 100 Ncm.
 CONTACT RESISTANCE: < 100 m Ω.
 INSULATION RESISTANCE: > 10⁹ Ω
 DIELECTRIC STRENGTH: 500 V rms.

NOTE: For the latest information regarding RoHS compliance, please go to: www.ittcannon.com/rohs.

NOTE: Specifications and materials listed above are for switches with standard options. For information on specific and custom switches, consult Customer Service Center.

Materials

HOUSING: PBT thermoplastic and PC thermoplastic
 STATIONARY CONTACTS & TERMINALS: Nickel alloy, gold or silver plated, insert molded in PBT thermoplastic.
 ROTOR: Printed circuit, gold or silver plated.
 ACTUATOR: Steel
 BUSHING: Brass
 HARDWARE: Stop pin and spring: Stainless steel

All models are RoHS compliant and compatible.

Build-A-Switch

To order, simply select desired option from each category and place in the appropriate box. Available options are shown and described on pages L-33 thru L-37. For additional options not shown in catalog, consult Customer Service Center.

Rotary

Designation
RTBV

Indexing
15 15°
22.5 22.5°
30 30°
36 36°

Number of Switch Functions**
1 1 Function
2 2 Functions

Switch Function
Number of Poles (first digit)
Number of Positions (second & third digit) or code
116 SP, 16 positions
112 SP, 12 positions
206 DP, 6 positions
B Binary code
C Complement
BC Direct + complement

Stops
B Stop with number of positions
S Without

Mounting Style
AD Standard bushing for panel mount
DE Sealed bushing for panel mount

Shaft Diameter
D6 6 mm (.236)
D63 6.35 mm (.250)

Option of Shaft (NONE)
M10X5 Shaft with flat

Actuator Option Angle* (NONE)
K0 0° angle
K60 60° angle
K90 90° angle
K120 120° angle
K180 180° angle
K270 270° angle

Actuator Length
25 25 mm (.984)

Contact Material
S Silver plated
G Gold plated

* Other angles available by request

** Several functions can be combined. For more information consult us.



Dimensions are shown: Inch (mm)
 Specifications and dimensions subject to change

C&K RTBV Series 1-2 Pole Coded Rotary Switches

DESIGNATION



RTBV

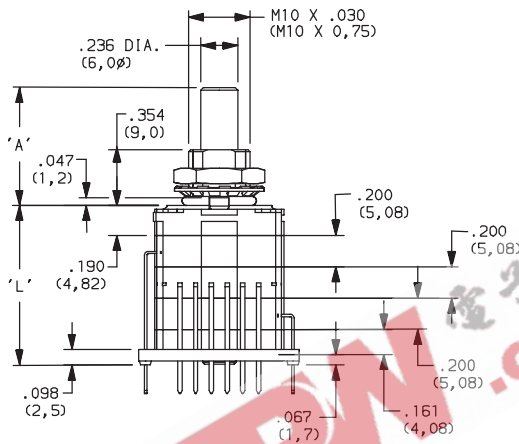
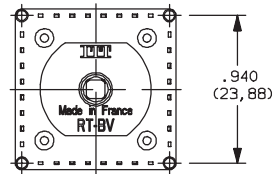

INDEXING



15 15° index, 24 POSITIONS MAXIMUM

22.5 22.5° index, 16 POSITIONS MAXIMUM

30 30° index, 12 POSITIONS MAXIMUM

36 36° index, 10 POSITIONS MAXIMUM



Dimensions are shown: Inch (mm)
Specifications and dimensions subject to change

C&K RTBV Series 1-2 Pole Coded Rotary Switches

NUMBER OF SWITCH FUNCTIONS



- 1** 1 FUNCTION
- 2** 2 FUNCTIONS

NOTE: Several functions can be combined. For more information consult us.

NUMBER OF POLES / POSITIONS



- 116** 22.5 INDEX, SP, 16 POSITIONS
- 112** 30 INDEX, SP, 12 POSITIONS
- 206** 30 INDEX, DP, 6 POSITIONS
- B** BINARY CODE, 15 /22.5 /30 /36
- C** COMPLEMENT, 15 /22.5 /30 /36
- BC** DIRECT + COMPLEMENT, 15 /22.5 /30 /36

SINGLE POLE FUNCTION

	C	1	2	3	4	5	6	7	8	9	10	11	12	13	14	15	16	17	18	19	20	21	22	23	24
1	●	●																							
2	●		●																						
3	●			●																					
4	●				●																				
5	●					●																			
6	●						●																		
7	●							●																	
8	●								●																
9	●									●															
10	●										●														
11	●											●													
12	●	●											●												
13	●		●											●											
14	●			●											●										
15	●				●											●									
16	●					●											●								
17	●						●											●							
18	●							●											●						
19	●								●											●					
20	●									●											●				
21	●										●											●			
22	●											●											●		
23	●												●											●	
24	●													●											●



Rotary

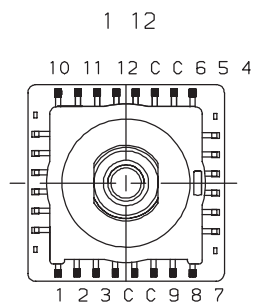

Dimensions are shown: Inch (mm)
Specifications and dimensions subject to change

C&K RTBV Series 1-2 Pole Coded Rotary Switches

NUMBER OF POLES / POSITIONS



DOUBLE POLE FUNCTION

	C ₁	1 ₁	2 ₁	3 ₁	4 ₁	5 ₁	6 ₁	C ₂	1 ₂	2 ₂	3 ₂	4 ₂	5 ₂	6 ₂
1	●	●						●	●					
2	●		●					●		●				
3	●			●				●			●			
4	●				●			●				●		
5	●					●		●					●	
6	●						●	●						●



BINARY DIRECT CODE

	C	1	2	4	8	16
0	●	●	●	●	●	●
1	●	●	●	●	●	●
2	●	●	●	●	●	●
3	●	●	●	●	●	●
4	●	●	●	●	●	●
5	●	●	●	●	●	●
6	●	●	●	●	●	●
7	●	●	●	●	●	●
8	●	●	●	●	●	●
9	●	●	●	●	●	●
10	●	●	●	●	●	●
11	●	●	●	●	●	●
12	●	●	●	●	●	●
13	●	●	●	●	●	●
14	●	●	●	●	●	●
15	●	●	●	●	●	●
16	●	●	●	●	●	●
17	●	●	●	●	●	●
18	●	●	●	●	●	●
19	●	●	●	●	●	●
20	●	●	●	●	●	●
21	●	●	●	●	●	●
22	●	●	●	●	●	●
23	●	●	●	●	●	●

B10 B12 B16



B24

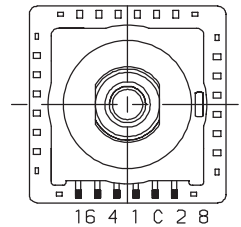

COMPLEMENT BINARY CODE

	C	1	2	4	8	16
0	●	●	●	●	●	●
1	●	●	●	●	●	●
2	●	●	●	●	●	●
3	●	●	●	●	●	●
4	●	●	●	●	●	●
5	●	●	●	●	●	●
6	●	●	●	●	●	●
7	●	●	●	●	●	●
8	●	●	●	●	●	●
9	●	●	●	●	●	●
10	●	●	●	●	●	●
11	●	●	●	●	●	●
12	●	●	●	●	●	●
13	●	●	●	●	●	●
14	●	●	●	●	●	●
15	●	●	●	●	●	●
16	●	●	●	●	●	●
17	●	●	●	●	●	●
18	●	●	●	●	●	●
19	●	●	●	●	●	●
20	●	●	●	●	●	●
21	●	●	●	●	●	●
22	●	●	●	●	●	●
23	●	●	●	●	●	●

C10 C12 C16



C24



DIRECT AND COMPLEMENT BINARY CODE

	C	1	2	4	8	16	C	1	2	4	8	16
0	●	●	●	●	●	●	●	●	●	●	●	●
1	●	●	●	●	●	●	●	●	●	●	●	●
2	●	●	●	●	●	●	●	●	●	●	●	●
3	●	●	●	●	●	●	●	●	●	●	●	●
4	●	●	●	●	●	●	●	●	●	●	●	●
5	●	●	●	●	●	●	●	●	●	●	●	●
6	●	●	●	●	●	●	●	●	●	●	●	●
7	●	●	●	●	●	●	●	●	●	●	●	●
8	●	●	●	●	●	●	●	●	●	●	●	●
9	●	●	●	●	●	●	●	●	●	●	●	●
10	●	●	●	●	●	●	●	●	●	●	●	●
11	●	●	●	●	●	●	●	●	●	●	●	●
12	●	●	●	●	●	●	●	●	●	●	●	●
13	●	●	●	●	●	●	●	●	●	●	●	●
14	●	●	●	●	●	●	●	●	●	●	●	●
15	●	●	●	●	●	●	●	●	●	●	●	●
16	●	●	●	●	●	●	●	●	●	●	●	●
17	●	●	●	●	●	●	●	●	●	●	●	●
18	●	●	●	●	●	●	●	●	●	●	●	●
19	●	●	●	●	●	●	●	●	●	●	●	●
20	●	●	●	●	●	●	●	●	●	●	●	●
21	●	●	●	●	●	●	●	●	●	●	●	●
22	●	●	●	●	●	●	●	●	●	●	●	●
23	●	●	●	●	●	●	●	●	●	●	●	●

BC10 BC12 BC16

C 8 C 4 2 1

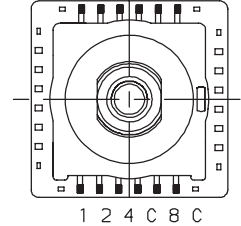

BC24

8 2 C 1 4 16

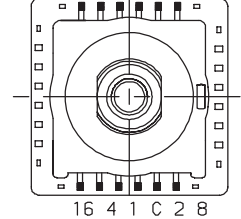

Third Angle Projection
Specifications and dimensions subject to change

C&K RTBV Series 1-2 Pole Coded Rotary Switches

STOPS

B STOP WITH NUMBER OF POSITIONS

S WITHOUT

EXAMPLE: 108B08 STOP AT 8TH POSITION

MOUNTING STYLE

AD STANDARD BUSHING FOR PANEL MOUNT



DE SEALED BUSHING FOR PANEL MOUNT

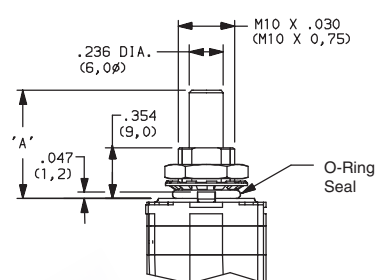

SHAFT DIAMETER

D6 6 mm (.236)

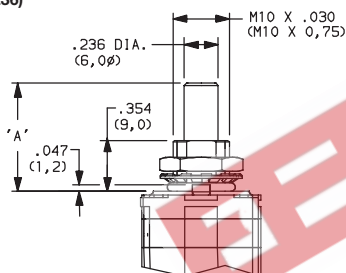

D63 6.35 mm (.250)

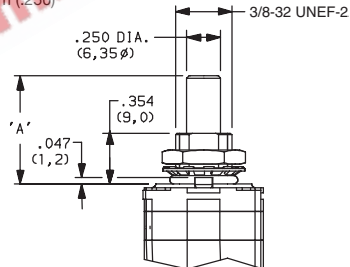

OPTION OF SHAFT

(NONE)



M10X5 FLAT

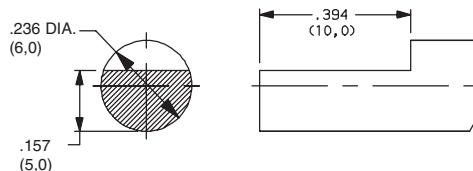

Rotary

C&K RTBV Series 1-2 Pole Coded Rotary Switches

ACTUATOR OPTION ANGLE



(NONE)



K0 0 ANGLE

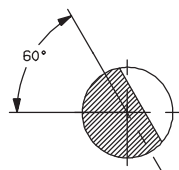

K60 60°

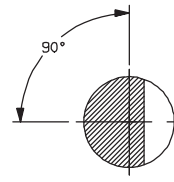

K90 90°



K120 120°



K180 210°

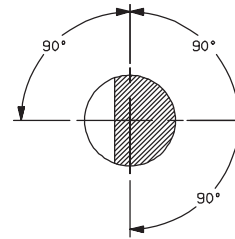

K270 300°



K0 0 ANGLE



K60 60°

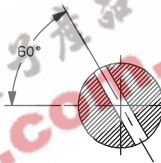

K90 90°

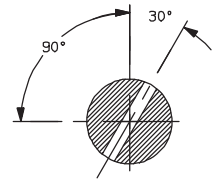

K120 120°

ACTUATOR LENGTH



25 0,25 mm (.984) STANDARD SHAFT

Other lengths available by request.

CONTACT MATERIAL



OPTION CODE	RoHS COMPLIANT*	RoHS COMPATIBLE*	CONTACT AND TERMINAL MATERIAL	RATING	
				LOW LEVEL/DRY CIRCUIT	SWITCH: 250 mA, POWER: 5 VA; CARRY: 5 AMPS
S	YES	YES	SILVER	LOW LEVEL/DRY CIRCUIT	SWITCH: 250 mA, POWER: 5 VA; CARRY: 5 AMPS
G	YES	YES	GOLD	LOW LEVEL/DRY CIRCUIT OR POWER	SWITCH: 20 mA, POWER: 0.2 VA; CARRY: 1 AMP

* Note: See Technical Data section of this catalog for RoHS compliant and compatible definition and specifications.



Dimensions are shown: Inch (mm)
Specifications and dimensions subject to change