

Selection Guide

Part No.	Dice	Lens Type	Iv (mcd) [2] @ 20mA		Viewing Angle [1]
			Min.	Typ.	2θ1/2
WP154A4SUREPBGVGAC	Hyper Red (InGaAlP)	WATER CLEAR	650	1300	50°
	Blue (InGaN)		280	800	
	Green (InGaN)		480	1200	

Notes:

1. θ1/2 is the angle from optical centerline where the luminous intensity is 1/2 the optical centerline value.
2. Luminous intensity/ luminous Flux: +/-15%.

Electrical / Optical Characteristics at TA=25°C

Symbol	Parameter	Device	Typ.	Max.	Units	Test Conditions
λpeak	Peak Wavelength	Hyper Red Blue Green	640 468 520		nm	If=20mA
λD [1]	Dominant Wavelength	Hyper Red Blue Green	630 470 525		nm	If=20mA
Δλ1/2	Spectral Line Half-width	Hyper Red Blue Green	25 21 35		nm	If=20mA
C	Capacitance	Hyper Red Blue Green	45 100 100		pF	Vf=0V;f=1MHz
Vf [2]	Forward Voltage	Hyper Red Blue Green	1.9 3.2 3.2	2.5 4 4	V	If=20mA
IR	Reverse Current	Hyper Red Blue Green		10 10 10	uA	VR=5V

Notes:

1. Wavelength: +/-1nm.
2. Forward Voltage: +/-0.1V.

Absolute Maximum Ratings at TA=25°C

Parameter	Hyper Red	Blue	Green	Units
Power dissipation	75	120	120	mW
DC Forward Current	30	30	30	mA
Peak Forward Current [1]	200	100	100	mA
Reverse Voltage	5			V
Operating/Storage Temperature	-40°C To +85°C			
Lead Solder Temperature [2]	260°C For 3 Seconds			
Lead Solder Temperature [3]	260°C For 5 Seconds			

Notes:

1. 1/10 Duty Cycle, 0.1ms Pulse Width.
2. 2mm below package base.
3. 5mm below package base.

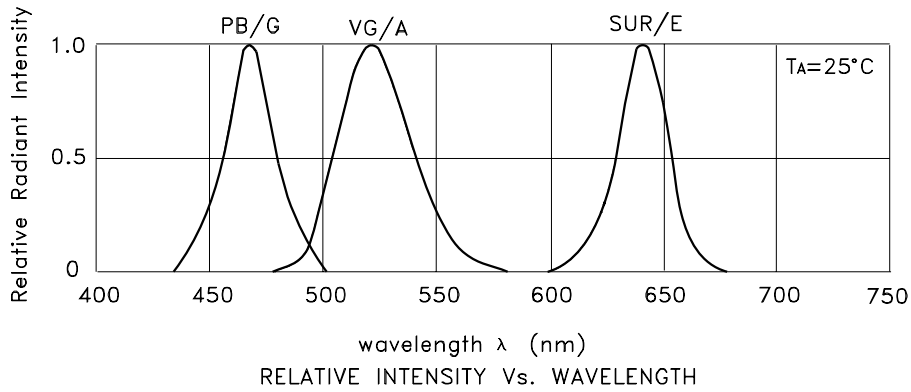

WP154A4SUREPBGVGAC Hyper Red

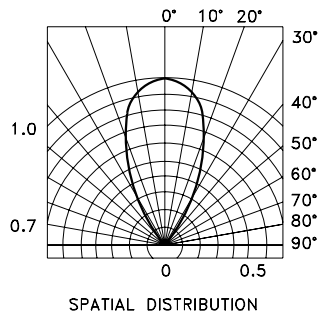
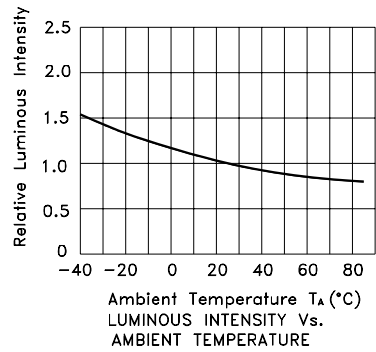
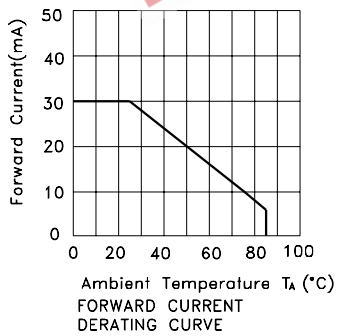
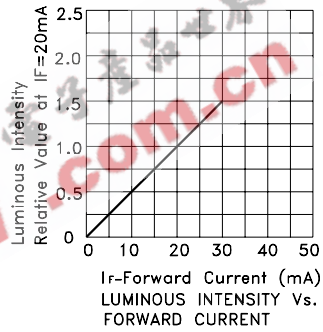
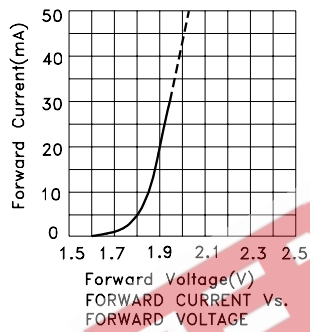

Kingbright

Blue

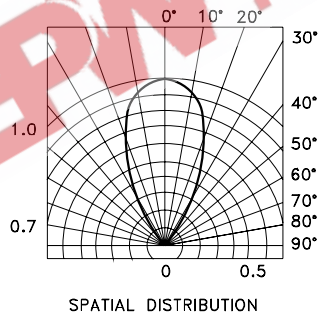
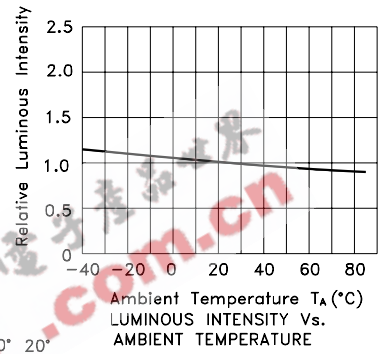
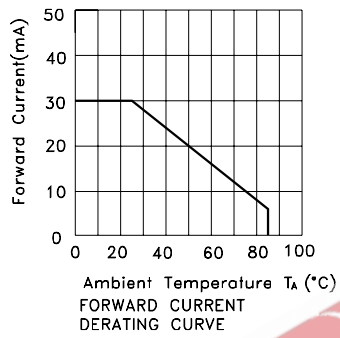
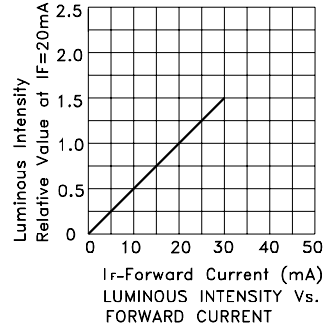
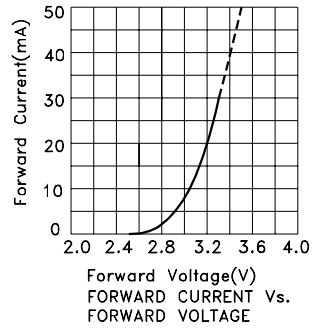

Green

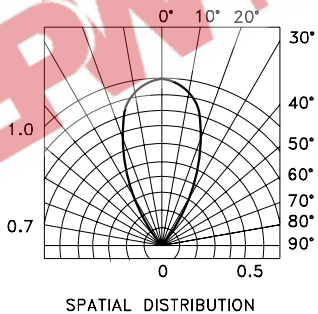
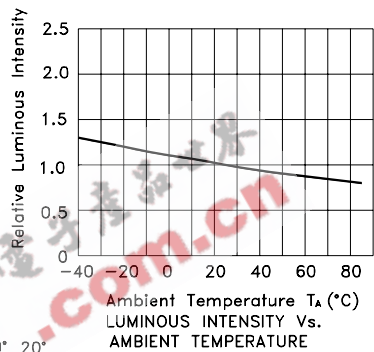
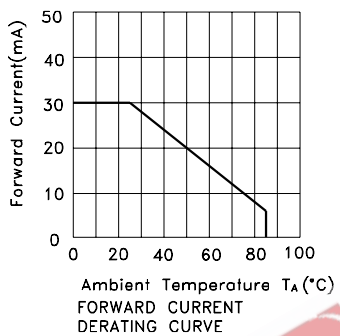
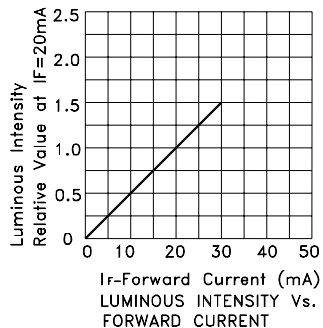
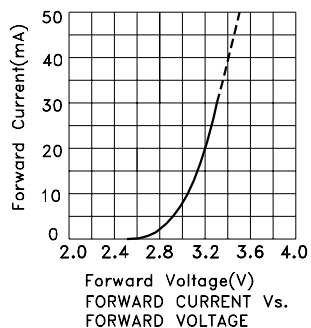

Kingbright

PACKING & LABEL SPECIFICATIONS

WP154A4SUREPBGVGAC

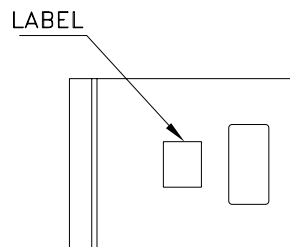
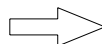
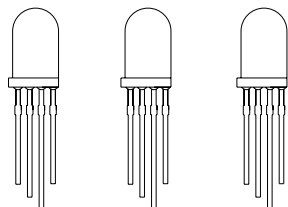

500PCS / BAG



20K / 9# BOX

OUTSIDE LABEL

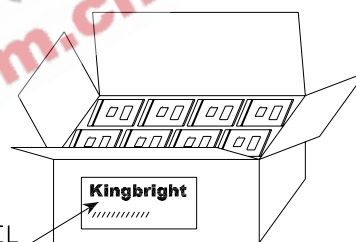

10K / 5# BOX

OUTSIDE LABEL

Kingbright	
Q.C.	QC XX XX XX PASSED
TYPE NO : WP154A4xxx	
QUANTITY : 500 pcs	
S/N : XX	CODE: XX
LOT NO :  xx-xxxx	
RoHS Compliant	

LED MOUNTING METHOD

1. The lead pitch of the LED must match the pitch of the mounting holes on the PCB during component placement. Lead-forming may be required to insure the lead pitch matches the hole pitch. Refer to the figure below for proper lead forming procedures.

(Fig. 1)

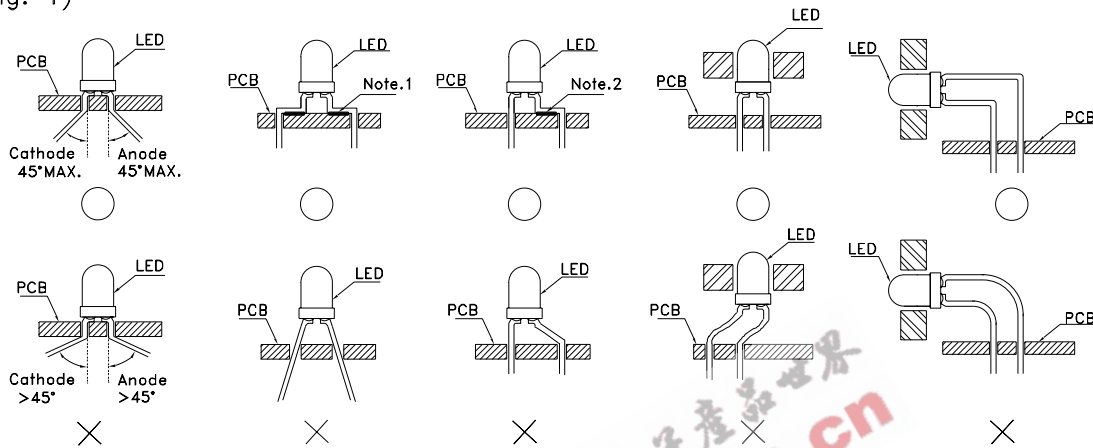

Fig. 1

“○” Correct mounting method “X” Incorrect mounting method

Note 1-2 : Do not route PCB trace in the contact area between the leadframe and the PCB to prevent short-circuits.

2. When soldering wire to the LED, use individual heat-shrink tubing to insulate the exposed leads to prevent accidental contact short-circuit.

(Fig. 2)

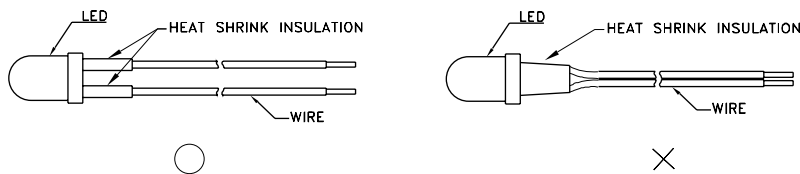

Fig. 2

3. Use stand-offs (Fig. 3) or spacers (Fig. 4) to securely position the LED above the PCB.

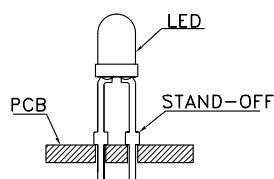

Fig. 3

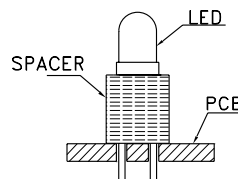

Fig. 4

LEAD FORMING PROCEDURES

1. Maintain a minimum of 2mm clearance between the base of the LED lens and the first lead bend. (Fig. 5 and 6)

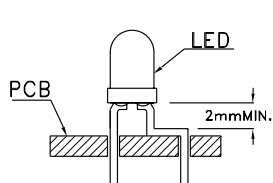

Fig. 5

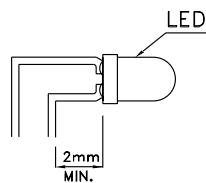

Fig. 6

2. Lead forming or bending must be performed before soldering, never during or after Soldering.
3. Do not stress the LED lens during lead-forming in order to fractures in the lens epoxy and damage the internal structures.
4. During lead forming, use tools or jigs to hold the leads securely so that the bending force will not be transmitted to the LED lens and its internal structures. Do not perform lead forming once the component has been mounted onto the PCB. (Fig. 7)
5. Do not bend the leads more than twice. (Fig. 8)

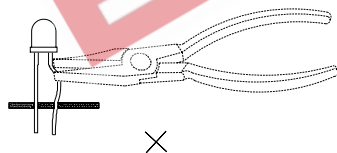

Fig. 7

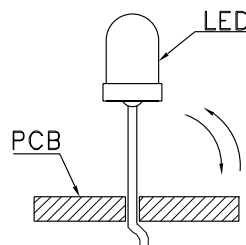

Fig. 8

6. After soldering or other high-temperature assembly, allow the LED to cool down to 50°C before applying outside force (Fig. 9). In general, avoid placing excess force on the LED to avoid damage. For any questions please consult with Kingbright representative for proper handling procedures.

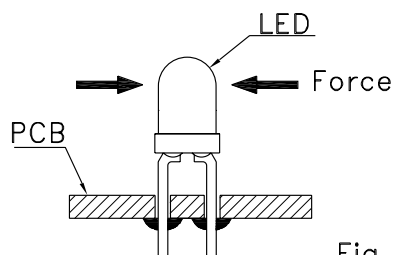

Fig. 9