



1.2W Audio Power Amplifier with Standby Mode Active High

- Operating from  $V_{CC} = 2.5V$  to  $5.5V$
- Rail-to-rail output
- 1.2W output power @  $V_{CC}=5V$ , THD=1%,  $F=1kHz$ , with  $8\Omega$  load
- Ultra low consumption in standby mode (10nA)
- 75dB PSRR @ 217Hz from 2.5 to 5V
- Low pop & click
- Ultra low distortion (0.05%)
- Unity gain stable
- Flip-chip package  $8 \times 300\mu m$  bumps

Description

The TS4972 is an Audio Power Amplifier capable of delivering 1.6W of continuous RMS output power into a  $4\Omega$  load @ 5V.

This Audio Amplifier is exhibiting 0.1% distortion level (THD) from a 5V supply for a  $P_{out} = 250mW$  RMS. An external standby mode control reduces the supply current to less than 10nA. An internal shutdown protection is provided.

The TS4972 has been designed for high quality audio applications such as mobile phones and to minimize the number of external components.

The unity-gain stable amplifier can be configured by external gain setting resistors.

Applications

- Mobile phones (cellular / cordless)
- PDAs
- Laptop/notebook computers
- Portable audio devices

Pin Connections (top view)

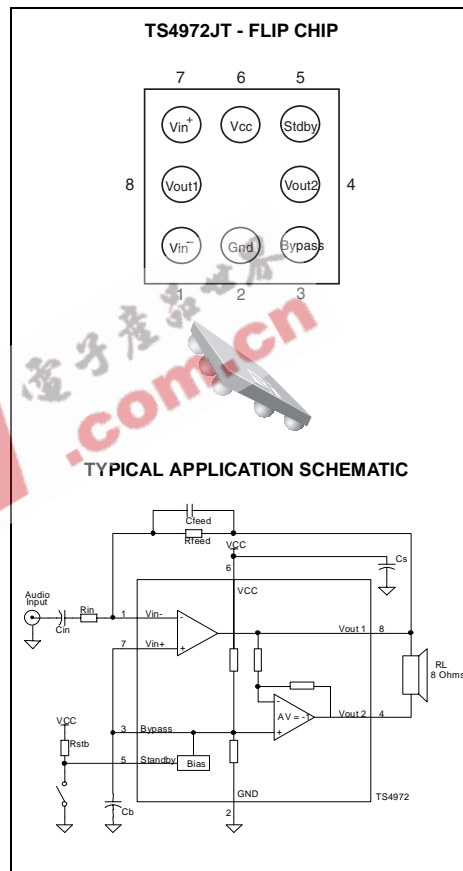

Order Codes

Part Number	Temperature Range	Package	Packing	Marking
TS4972IJT TS4972EIJT <sup>1</sup>	-40, +85°C	Flip-Chip	Tape & Reel	4972

1) Lead free Flip-Chip part number

## 1 Absolute Maximum Ratings

Table 1: Key parameters and their absolute maximum ratings

Symbol	Parameter	Value	Unit
VCC	Supply voltage <sup>1</sup>	6	V
V <sub>i</sub>	Input Voltage <sup>2</sup>	G <sub>ND</sub> to V <sub>CC</sub>	V
T <sub>oper</sub>	Operating Free Air Temperature Range	-40 to + 85	°C
T <sub>stg</sub>	Storage Temperature	-65 to +150	°C
T <sub>j</sub>	Maximum Junction Temperature	150	°C
R <sub>thja</sub>	Thermal Resistance Junction to Ambient <sup>3</sup>	200	°C/W
P <sub>d</sub>	Power Dissipation	Internally Limited <sup>4</sup>	
ESD	Human Body Model	2	kV
ESD	Machine Model	200	V
Latch-up	Latch-up Immunity	Class A	
	Lead Temperature (soldering, 10sec)	250	°C

1) All voltages values are measured with respect to the ground pin.

2) The magnitude of input signal must never exceed V<sub>CC</sub> + 0.3V / G<sub>ND</sub> - 0.3V

3) Device is protected in case of over temperature by a thermal shutdown active @ 150°C.

4) Exceeding the power derating curves during a long period, involves abnormal operating condition.

Table 2: Operating Conditions

Symbol	Parameter	Value	Unit
VCC	Supply Voltage	2.5 to 5.5	V
V <sub>ICM</sub>	Common Mode Input Voltage Range	G <sub>ND</sub> to V <sub>CC</sub> - 1.2V	V
VSTB	Standby Voltage Input : Device ON Device OFF	G <sub>ND</sub> ≤ V <sub>STB</sub> ≤ 0.5V V <sub>CC</sub> - 0.5V ≤ V <sub>STB</sub> ≤ V <sub>CC</sub>	V
RL	Load Resistor	4 - 32	Ω
R <sub>thja</sub>	Thermal Resistance Junction to Ambient <sup>1</sup>	90	°C/W

1) With Heat Sink Surface = 125mm<sup>2</sup>

## 2 Electrical Characteristics

**Table 3:  $V_{CC} = +5V$ ,  $GND = 0V$ ,  $T_{amb} = 25^{\circ}C$  (unless otherwise specified)**

Symbol	Parameter	Min.	Typ.	Max.	Unit
$I_{CC}$	Supply Current No input signal, no load		6	8	mA
$I_{STANDBY}$	Standby Current <sup>1</sup> No input signal, $V_{stdby} = V_{CC}$ , $R_L = 8\Omega$		10	1000	nA
$V_{OO}$	Output Offset Voltage No input signal, $R_L = 8\Omega$		5	20	mV
$P_O$	Output Power THD = 1% Max, $f = 1kHz$ , $R_L = 8\Omega$		1.2		W
THD + N	Total Harmonic Distortion + Noise $P_O = 250mW$ rms, $G_v = 2$ , $20Hz < f < 20kHz$ , $R_L = 8\Omega$		0.1		%
PSRR	Power Supply Rejection Ratio <sup>2</sup> $f = 217Hz$ , $R_L = 8\Omega$ , $R_{Feed} = 22K\Omega$ , $V_{ripple} = 200mV$ rms		75		dB
$\Phi_M$	Phase Margin at Unity Gain $R_L = 8\Omega$ , $C_L = 500pF$		70		Degrees
GM	Gain Margin $R_L = 8\Omega$ , $C_L = 500pF$		20		dB
GBP	Gain Bandwidth Product $R_L = 8\Omega$		2		MHz

1) Standby mode is activated when  $V_{stdby}$  is tied to  $V_{CC}$

2) Dynamic measurements -  $20 \cdot \log(\text{rms}(V_{out})/\text{rms}(V_{ripple}))$ .  $V_{ripple}$  is an added sinus signal to  $V_{CC}$  @  $f = 217Hz$

Table 4:  $V_{CC} = +3.3V$ ,  $GND = 0V$ ,  $T_{amb} = 25^{\circ}C$  (unless otherwise specified)<sup>3)</sup>

Symbol	Parameter	Min.	Typ.	Max.	Unit
$I_{CC}$	Supply Current No input signal, no load		5.5	8	mA
$I_{STANDBY}$	Standby Current <sup>1</sup> No input signal, $V_{stdby} = V_{CC}$ , $R_L = 8\Omega$		10	1000	nA
$V_{OO}$	Output Offset Voltage No input signal, $R_L = 8\Omega$		5	20	mV
$P_O$	Output Power THD = 1% Max, $f = 1kHz$ , $R_L = 8\Omega$		500		mW
THD + N	Total Harmonic Distortion + Noise $P_O = 250mW$ rms, $G_v = 2$ , $20Hz < f < 20kHz$ , $R_L = 8\Omega$		0.1		%
PSRR	Power Supply Rejection Ratio <sup>2</sup> $f = 217Hz$ , $R_L = 8\Omega$ , $R_{Feed} = 22K\Omega$ , $V_{ripple} = 200mV$ rms		75		dB
$\Phi_M$	Phase Margin at Unity Gain $R_L = 8\Omega$ , $C_L = 500pF$		70		Degrees
GM	Gain Margin $R_L = 8\Omega$ , $C_L = 500pF$		20		dB
GBP	Gain Bandwidth Product $R_L = 8\Omega$		2		MHz

1) Standby mode is activated when  $V_{stdby}$  is tied to  $V_{CC}$

2) Dynamic measurements -  $20 \cdot \log(\text{rms}(V_{out})/\text{rms}(V_{ripple}))$ .  $V_{ripple}$  is an added sinus signal to  $V_{CC}$  @  $f = 217Hz$

3. All electrical values are made by correlation between 2.6V and 5V measurements

Table 5:  $V_{CC} = 2.6V$ ,  $GND = 0V$ ,  $T_{amb} = 25^{\circ}C$  (unless otherwise specified)

Symbol	Parameter	Min.	Typ.	Max.	Unit
$I_{CC}$	Supply Current No input signal, no load		5.5	8	mA
$I_{STANDBY}$	Standby Current <sup>1</sup> No input signal, $V_{stdby} = V_{CC}$ , $R_L = 8\Omega$		10	1000	nA
$V_{OO}$	Output Offset Voltage No input signal, $R_L = 8\Omega$		5	20	mV
$P_o$	Output Power THD = 1% Max, $f = 1kHz$ , $R_L = 8\Omega$		300		mW
THD + N	Total Harmonic Distortion + Noise $P_o = 200mW$ rms, $G_v = 2$ , $20Hz < f < 20kHz$ , $R_L = 8\Omega$		0.1		%
PSRR	Power Supply Rejection Ratio <sup>2</sup> $f = 217Hz$ , $R_L = 8\Omega$ , $R_{Feed} = 22K\Omega$ , $V_{ripple} = 200mV$ rms		75		dB
$\Phi_M$	Phase Margin at Unity Gain $R_L = 8\Omega$ , $C_L = 500pF$		70		Degrees
GM	Gain Margin $R_L = 8\Omega$ , $C_L = 500pF$		20		dB
GBP	Gain Bandwidth Product $R_L = 8\Omega$		2		MHz

1) Standby mode is activated when  $V_{stdby}$  is tied to  $V_{CC}$

2) Dynamic measurements -  $20 \cdot \log(\text{rms}(V_{out})/\text{rms}(V_{ripple}))$ .  $V_{ripple}$  is an added sinus signal to  $V_{CC}$  @  $f = 217Hz$

Table 6: Components description

Components	Functional Description
$R_{in}$	Inverting input resistor which sets the closed loop gain in conjunction with $R_{feed}$ . This resistor also forms a high pass filter with $C_{in}$ ( $f_c = 1 / (2 \times \pi \times R_{in} \times C_{in})$ )
$C_{in}$	Input coupling capacitor which blocks the DC voltage at the amplifier input terminal
$R_{feed}$	Feed back resistor which sets the closed loop gain in conjunction with $R_{in}$
$C_s$	Supply Bypass capacitor which provides power supply filtering
$C_b$	Bypass pin capacitor which provides half supply filtering
$C_{feed}$	Low pass filter capacitor allowing to cut the high frequency (low pass filter cut-off frequency $1 / (2 \times \pi \times R_{feed} \times C_{feed})$ )
$R_{stb}$	Pull-up resistor which fixes the right supply level on the standby pin
$G_v$	Closed loop gain in BTL configuration = $2 \times (R_{feed} / R_{in})$

**Remarks:**

- All measurements, except PSRR measurements, are made with a supply bypass capacitor  $C_s = 100\mu F$ .
- External resistors are not needed for having better stability when supply @  $V_{CC}$  down to 3V. By the way, the quiescent current remains the same.
- The standby response time is about  $1\mu s$ .

Figure 1: Open Loop Frequency Response

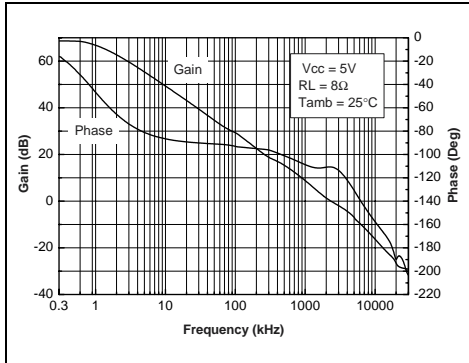

Figure 4: Open Loop Frequency Response

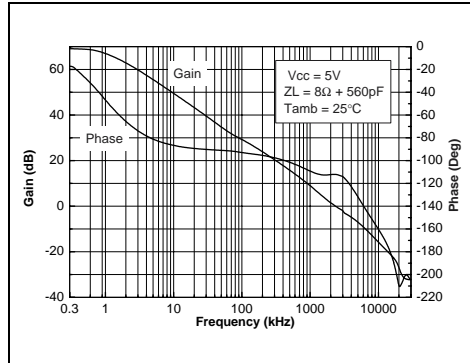

Figure 2: Open Loop Frequency Response

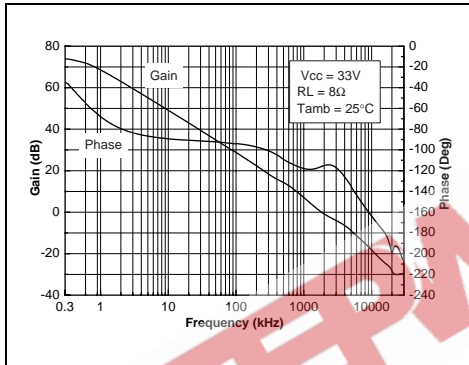

Figure 5: Open Loop Frequency Response

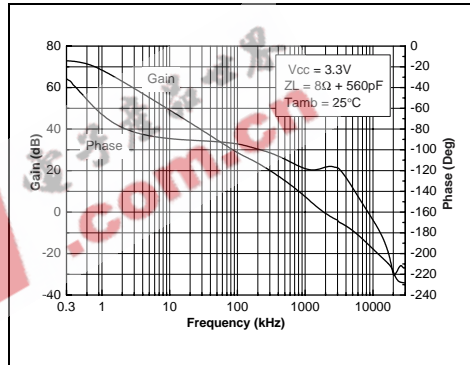

Figure 3: Open Loop Frequency Response

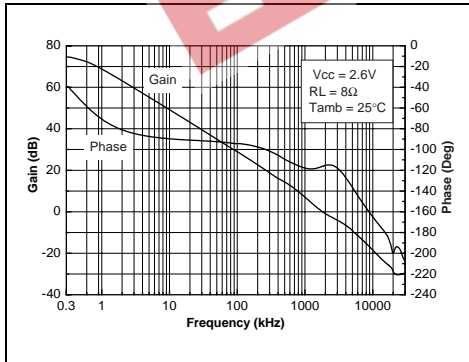

Figure 6: Open Loop Frequency Response

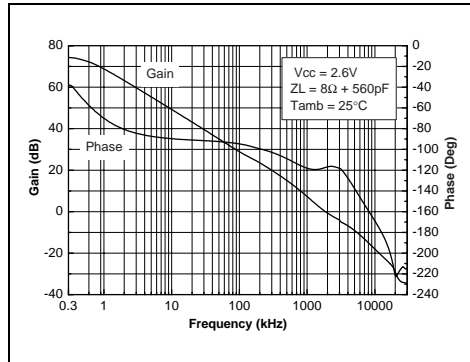

Figure 7: Open Loop Frequency Response

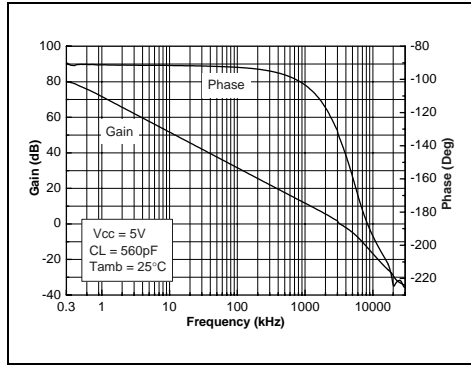

Figure 8: Open Loop Frequency Response

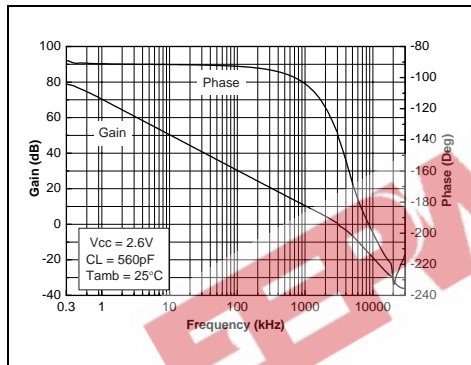

Figure 9: Open Loop Frequency Response

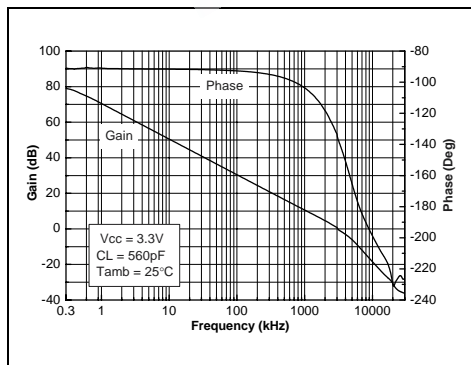

Figure 10: Power Supply Rejection Ratio (PSRR) vs Power supply

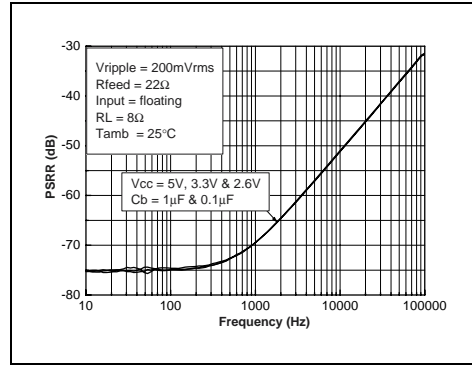

Figure 11: Power Supply Rejection Ratio (PSRR) vs Bypass Capacitor

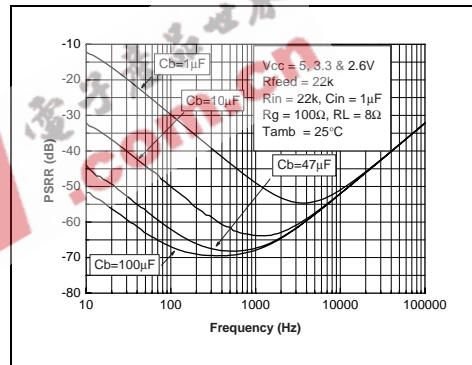

Figure 12: Power Supply Rejection Ratio (PSRR) vs Feedback Resistor

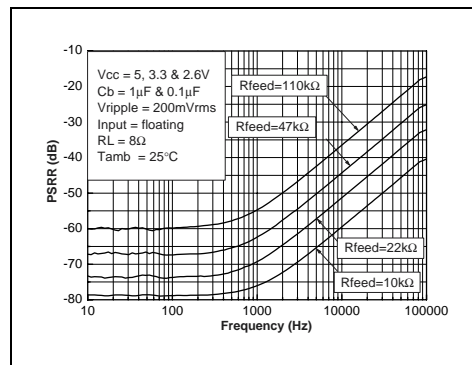

Figure 13: Power Supply Rejection Ratio (PSRR) vs Feedback Capacitor

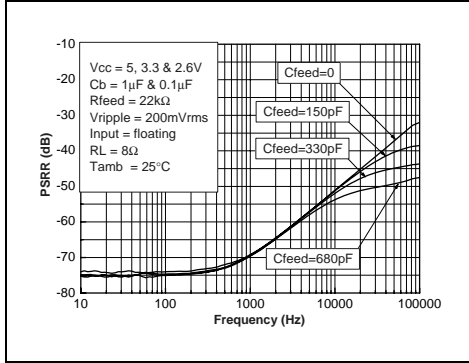

Figure 14: Power Supply Rejection Ratio (PSRR) vs Input Capacitor

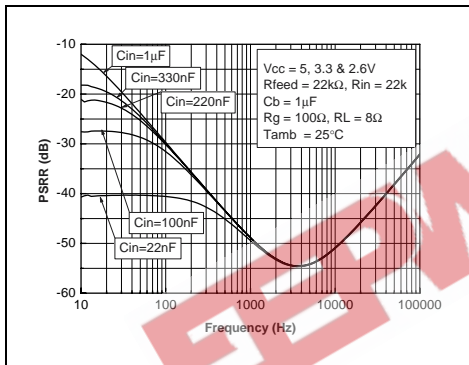

Figure 15: Pout @ THD + N = 1% vs Supply Voltage vs RL

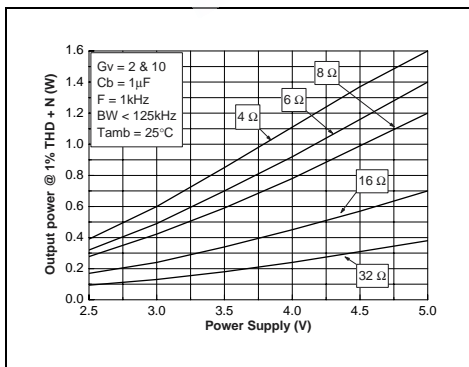

Figure 16: Power Dissipation vs Pout

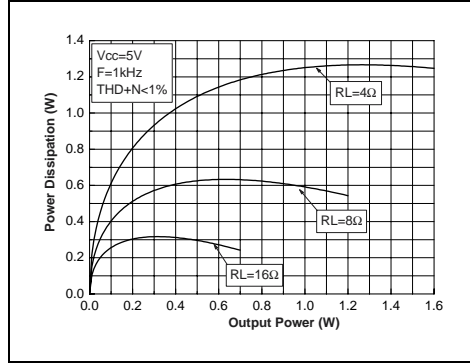

Figure 17: Power Dissipation vs Pout

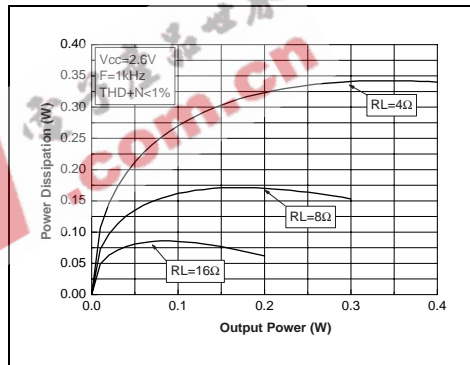

Figure 18: Pout @ THD + N = 10% vs Supply Voltage vs RL

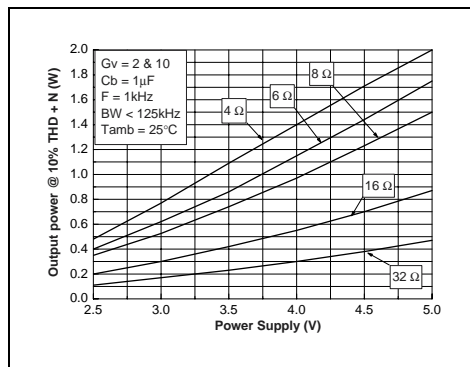



Figure 19: Power Dissipation vs Pout

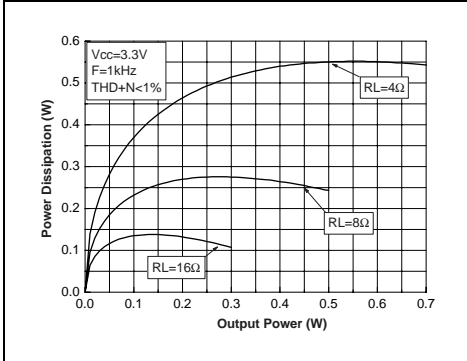

Figure 20: Power Derating Curves

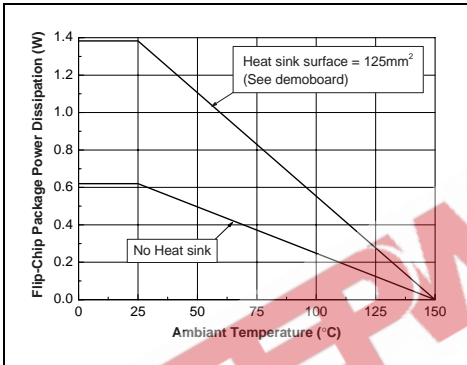

Figure 21: THD + N vs Output Power

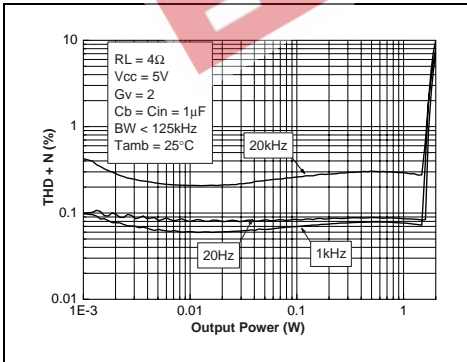

Figure 22: THD + N vs Output Power

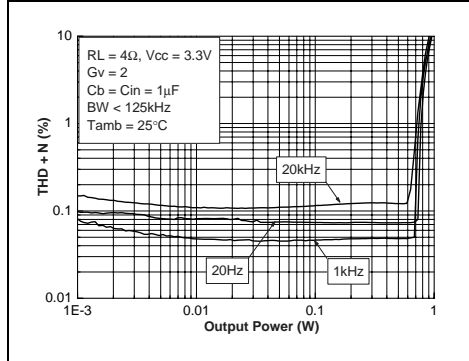

Figure 23: THD + N vs Output Power

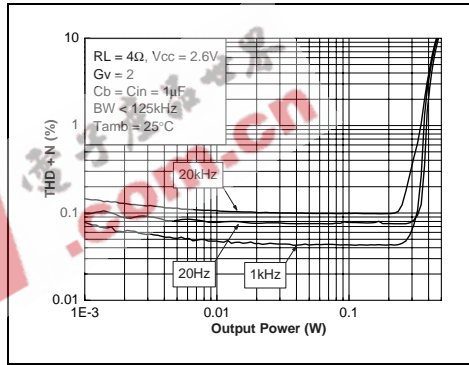

Figure 24: THD + N vs Output Power

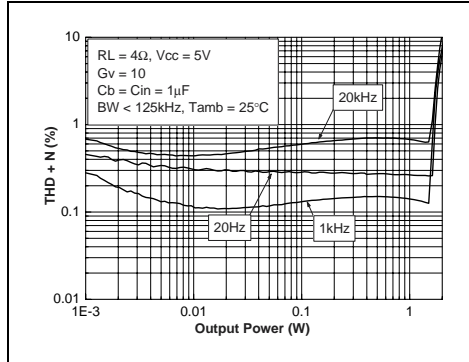

Figure 25: THD + N vs Output Power

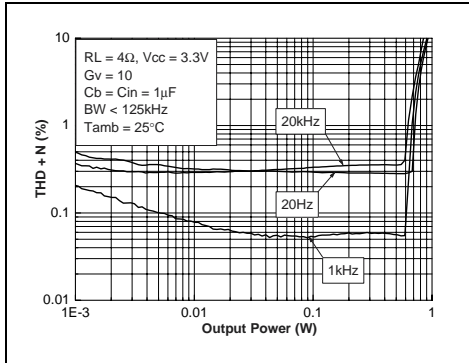

Figure 28: THD + N vs Output Power

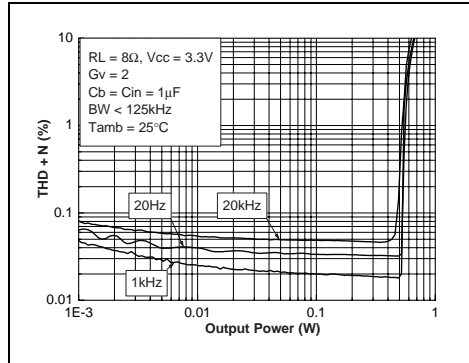

Figure 26: THD + N vs Output Power

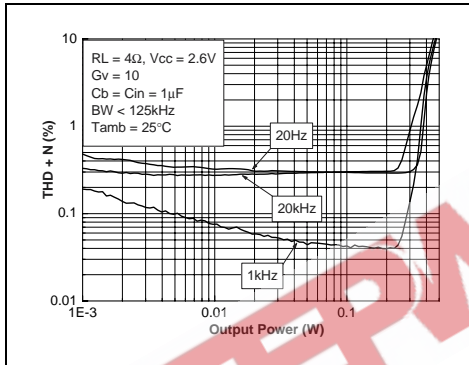

Figure 29: THD + N vs Output Power

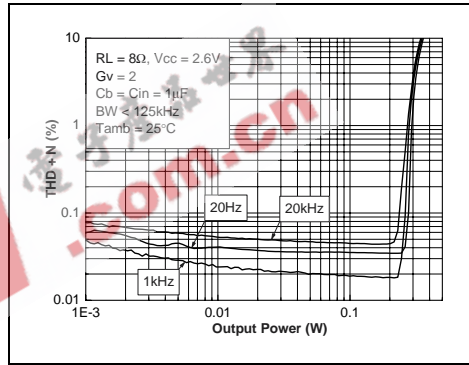

Figure 27: THD + N vs Output Power

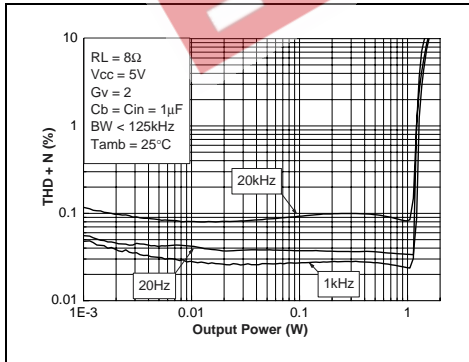

Figure 30: THD + N vs Output Power

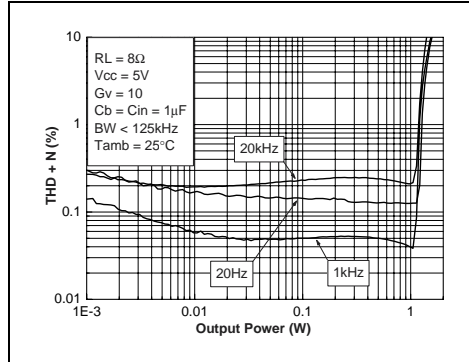

Figure 31: THD + N vs Output Power

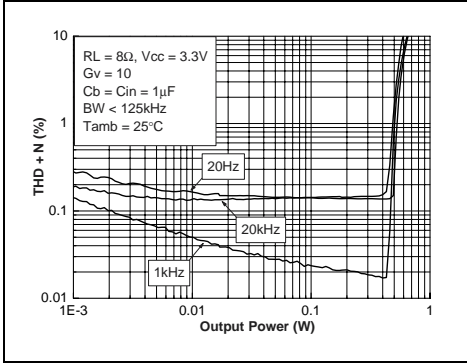

Figure 34: THD + N vs Output Power

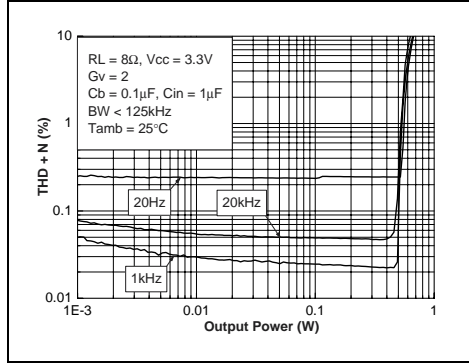

Figure 32: THD + N vs Output Power

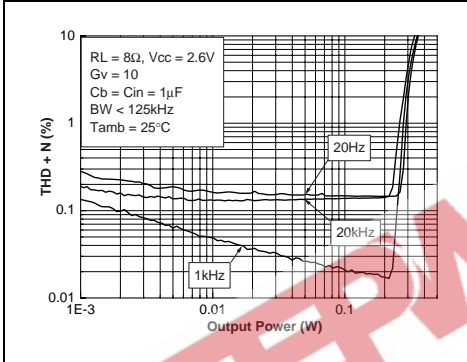

Figure 35: THD + N vs Output Power

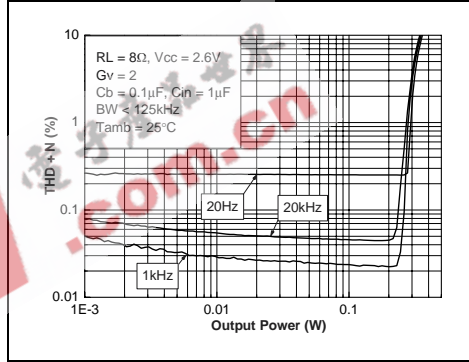

Figure 33: THD + N vs Output Power

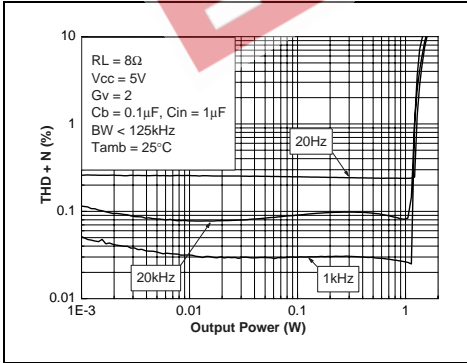

Figure 36: THD + N vs Output Power

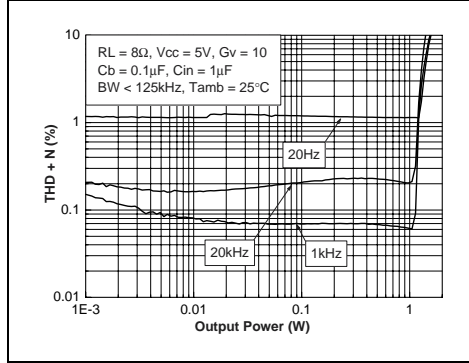

Figure 37: THD + N vs Output Power

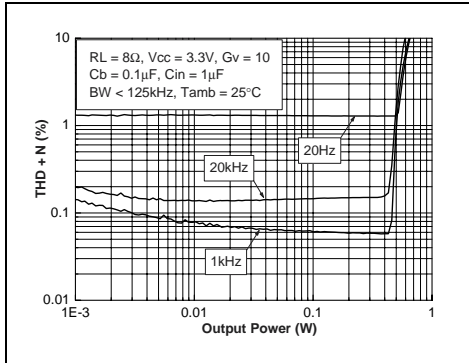

Figure 40: THD + N vs Output Power

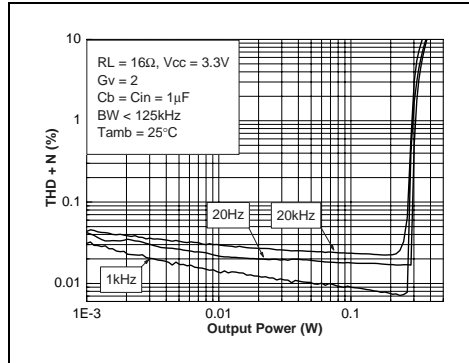

Figure 38: THD + N vs Output Power

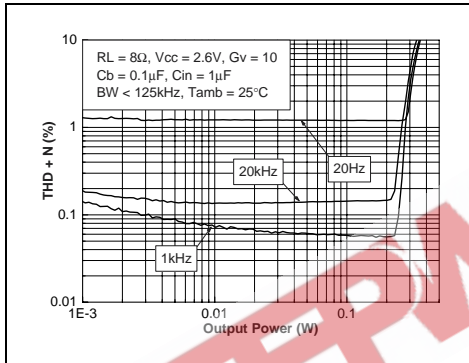

Figure 41: THD + N vs Output Power

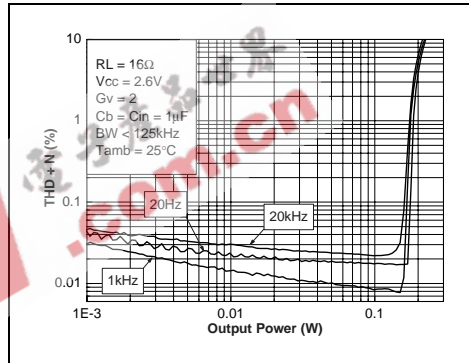

Figure 39: THD + N vs Output Power

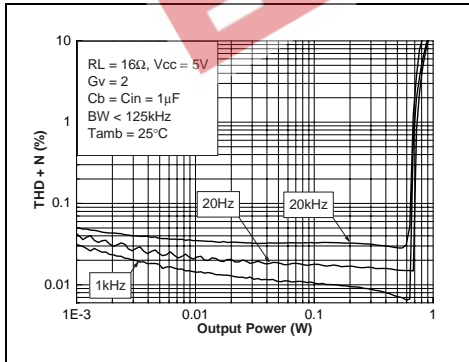

Figure 42: THD + N vs Output Power

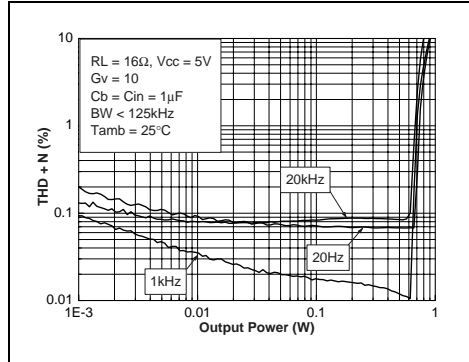

Figure 43: THD + N vs Output Power

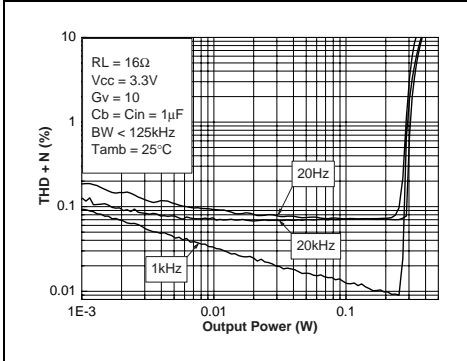

Figure 46: THD + N vs Frequency

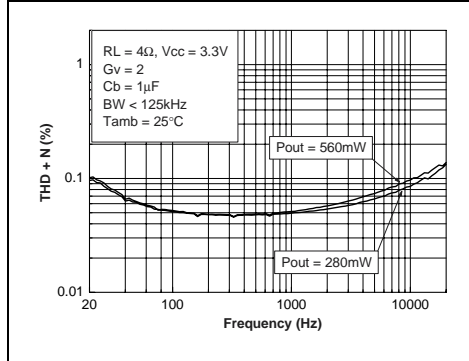

Figure 44: THD + N vs Output Power

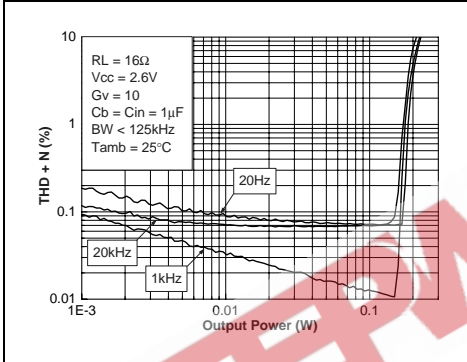

Figure 47: THD + N vs Frequency

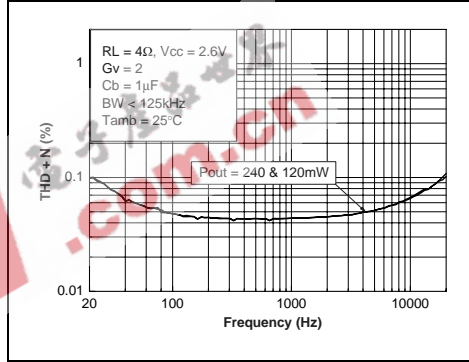

Figure 45: THD + N vs Frequency

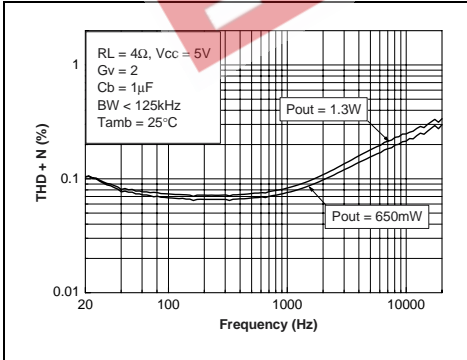

Figure 48: THD + N vs Frequency

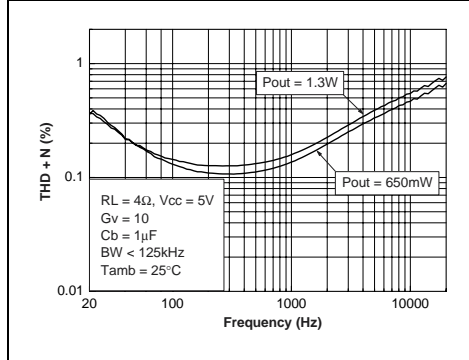

Figure 49: THD + N vs Frequency

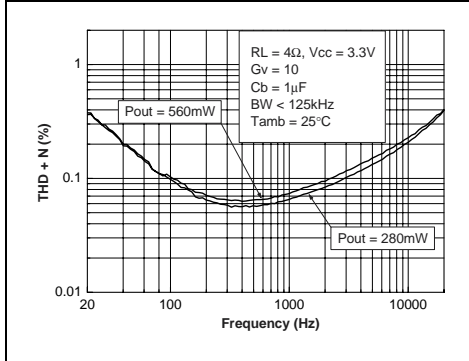

Figure 52: THD + N vs Frequency

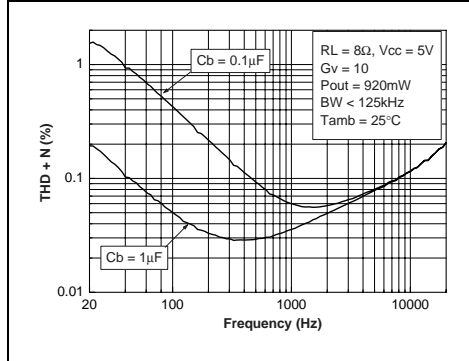

Figure 50: THD + N vs Frequency

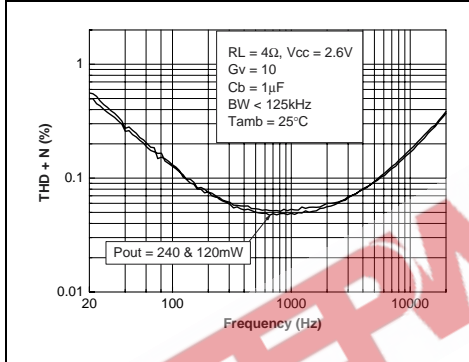

Figure 53: THD + N vs Frequency

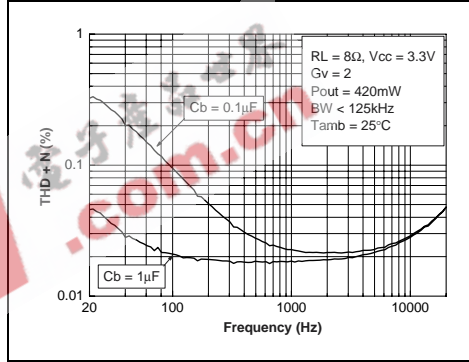

Figure 51: THD + N vs Frequency

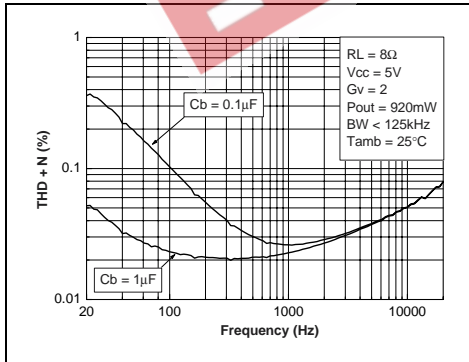

Figure 54: THD + N vs Frequency

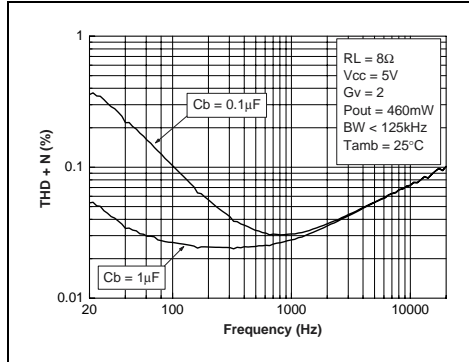

Figure 55: THD + N vs Frequency

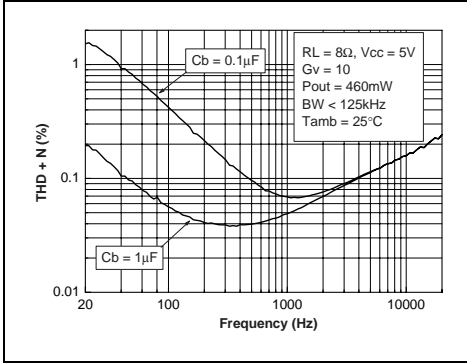

Figure 58: THD + N vs Frequency

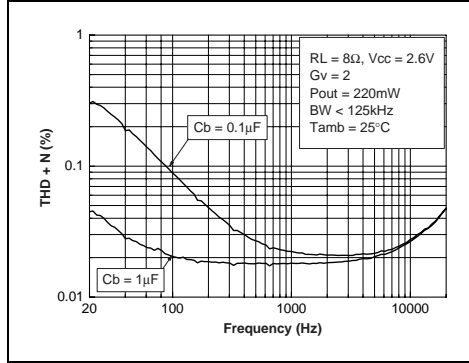

Figure 56: THD + N vs Frequency

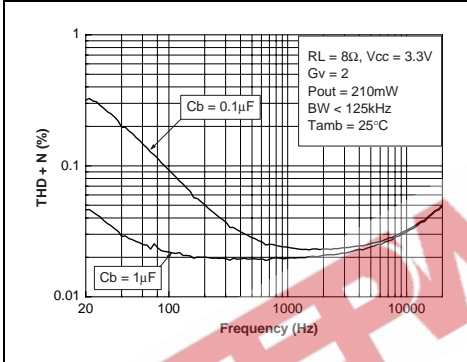

Figure 59: THD + N vs Frequency

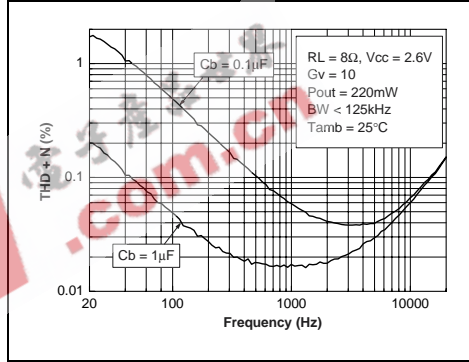

Figure 57: THD + N vs Frequency

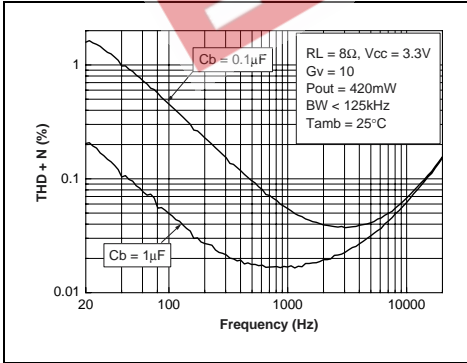

Figure 60: THD + N vs Frequency

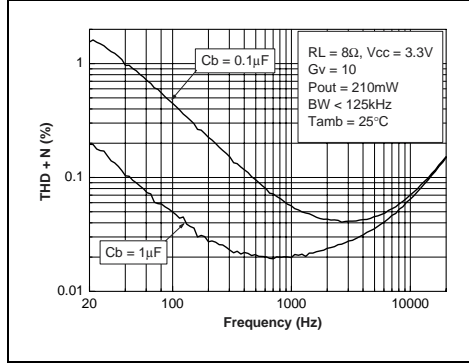

Figure 61: THD + N vs Frequency

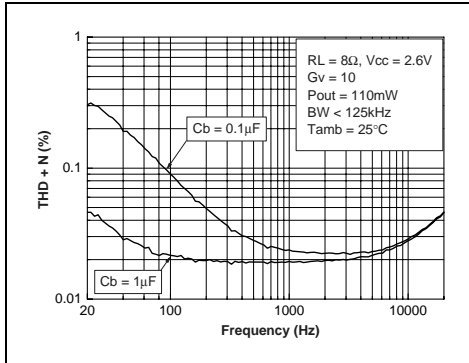

Figure 64: THD + N vs Frequency

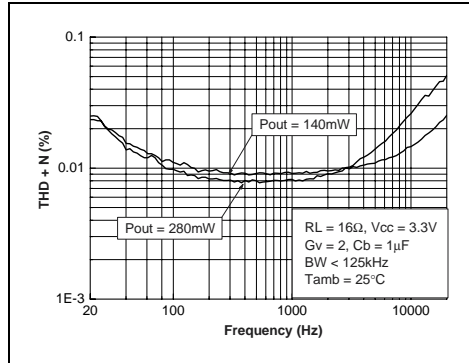

Figure 62: THD + N vs Frequency

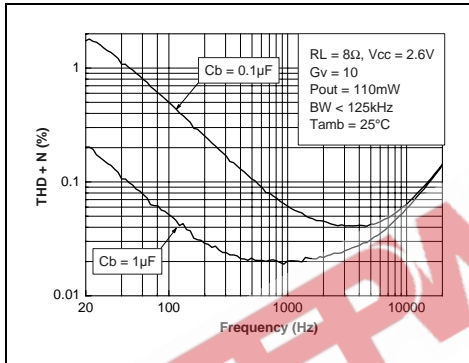

Figure 65: THD + N vs Frequency

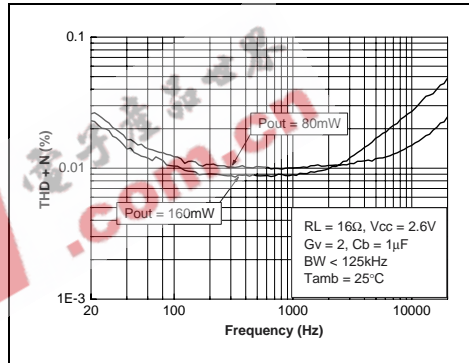

Figure 63: THD + N vs Frequency

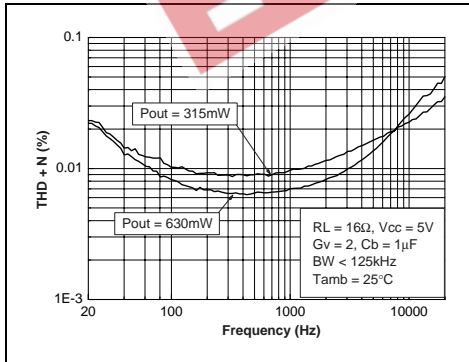

Figure 66: THD + N vs Frequency

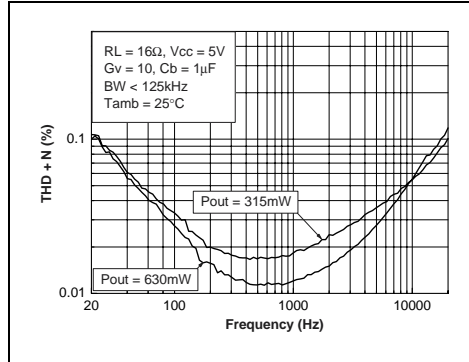



Figure 67: THD + N vs Frequency

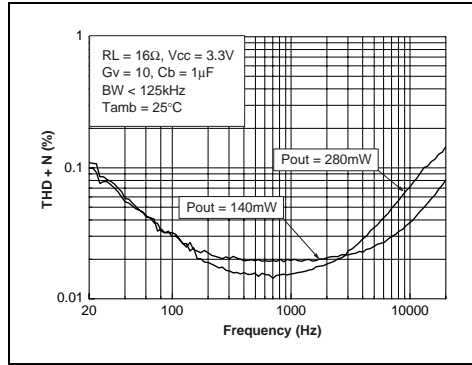

Figure 68: THD + N vs Frequency

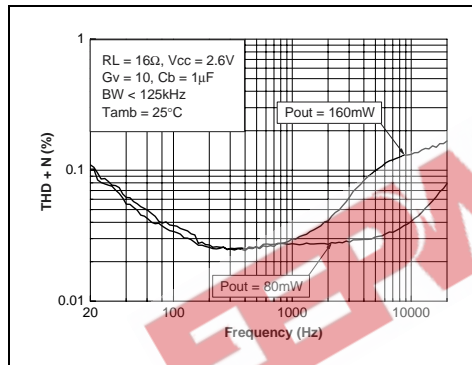

Figure 69: Signal to Noise Ratio vs Power Supply with Unweighted Filter (20Hz to 20kHz)

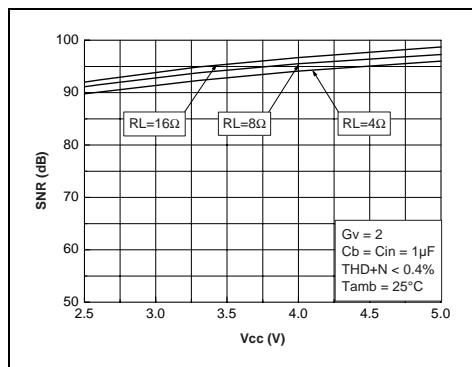

Figure 70: Signal to Noise Ratio vs Power Supply with Weighted Filter Type A

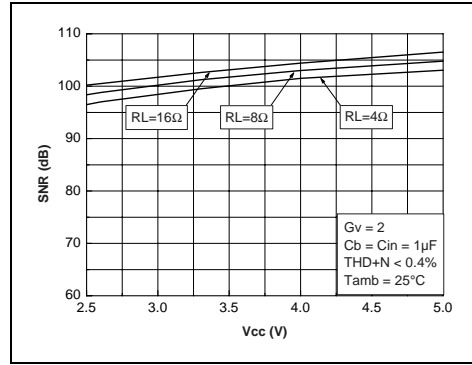

Figure 71: Frequency Response Gain vs Cin, & Cfeed

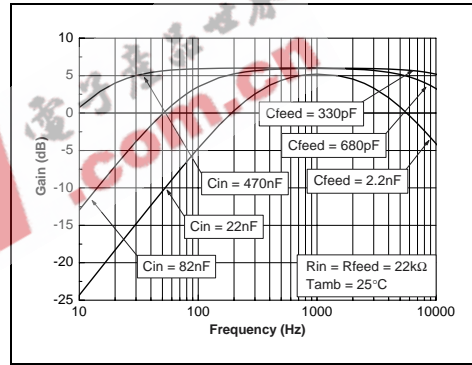

Figure 72: Signal to Noise Ratio vs Power Supply with Unweighted Filter (20Hz to 20kHz)

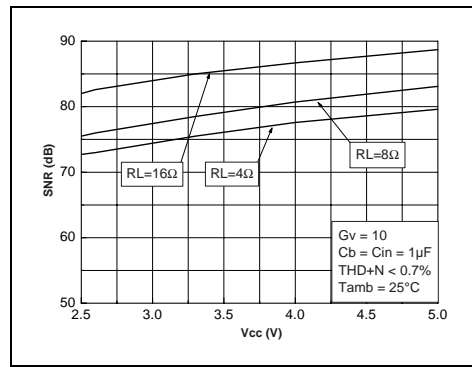

Figure 73: Signal to Noise Ratio vs Power Supply with Weighted Filter Type A

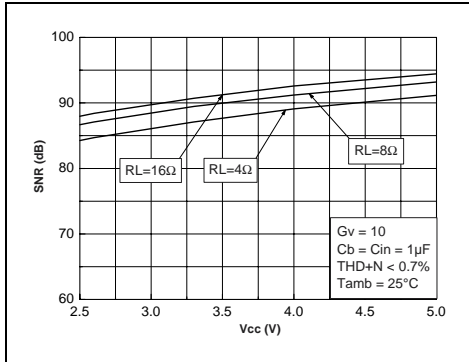

Figure 74: Current Consumption vs Power Supply Voltage

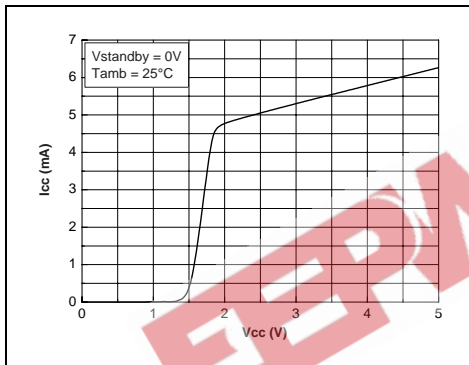

Figure 75: Current Consumption vs Standby Voltage @ Vcc = 5V

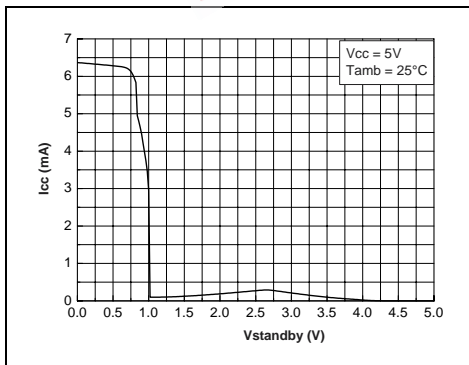

Figure 76: Current Consumption vs Standby Voltage @ Vcc = 2.6V

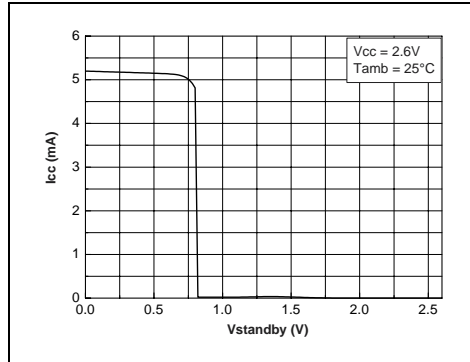

Figure 77: Clipping Voltage vs Power Supply Voltage and Load Resistor

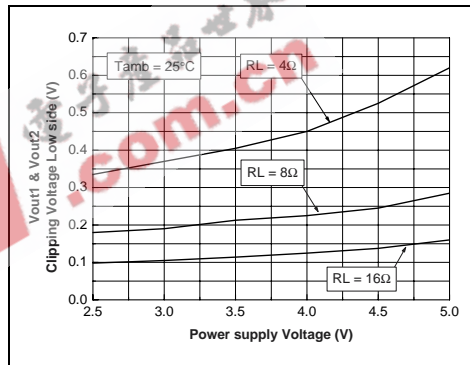

Figure 78: Current Consumption vs Standby Voltage @ Vcc = 3.3V

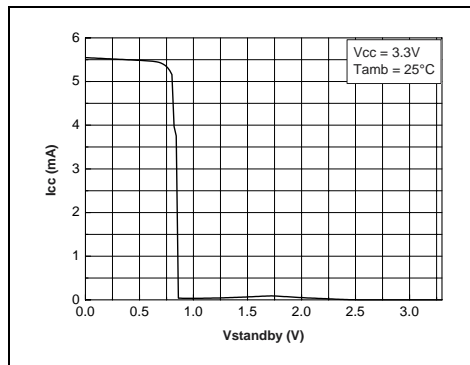
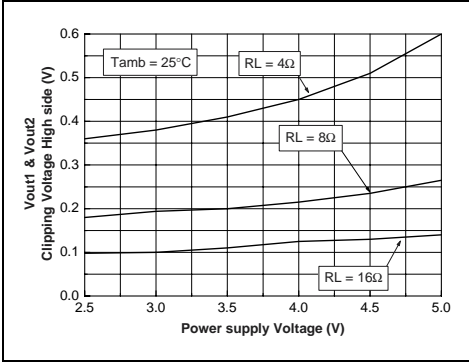

Figure 79: Clipping Voltage vs Power Supply Voltage and Load Resistor



EEPW 电子产品世界 .com.cn

3 Application Information

Figure 80: Demoboard Schematic

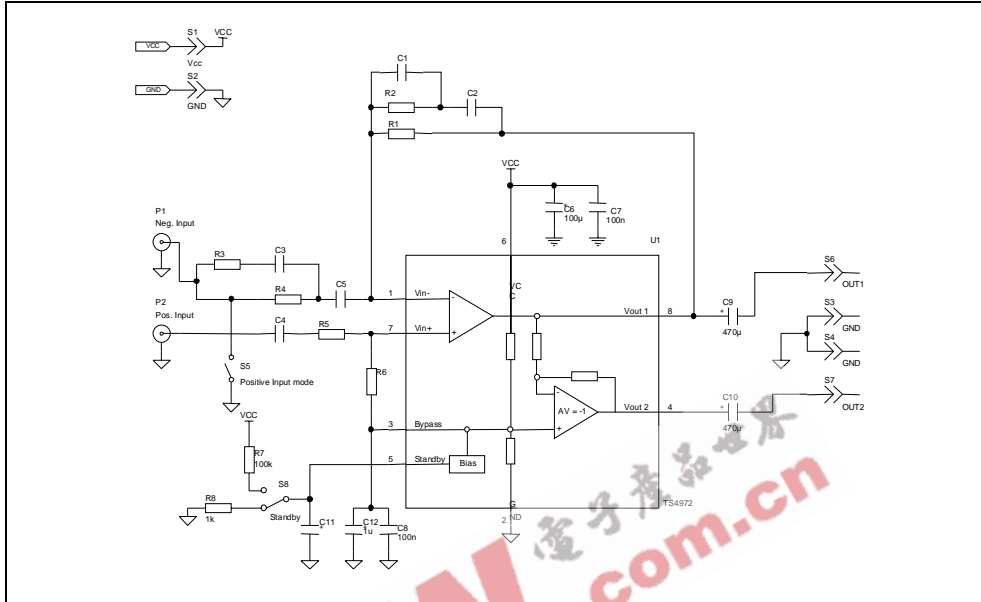

Figure 81: Flip-Chip 300µm Demoboard Components Side

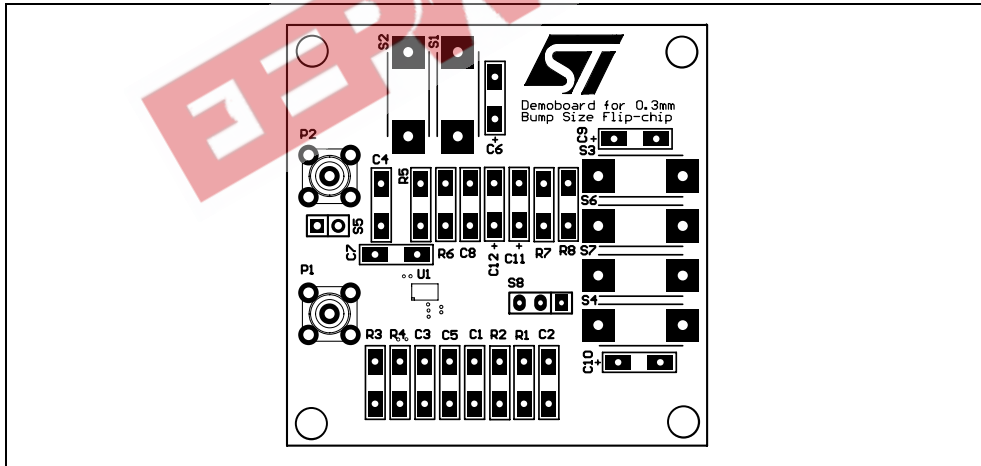

Figure 82: Flip-Chip 300µm Demoboard Top Solder Layer

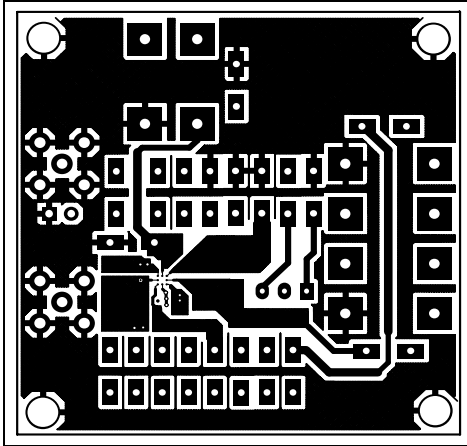
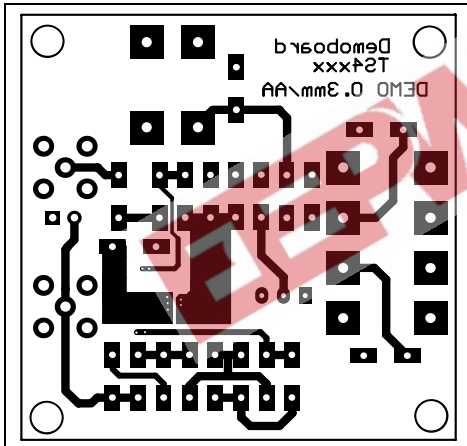

Figure 83: Flip-Chip 300µm Demoboard Bottom Solder Layer



#### ■ BTL Configuration Principle

The TS4972 is a monolithic power amplifier with a BTL output type. BTL (Bridge Tied Load) means that each end of the load is connected to two single ended output amplifiers. Thus, we have :

Single ended output 1 =  $V_{out1} = V_{out}$  (V)

Single ended output 2 =  $V_{out2} = -V_{out}$  (V)

And  $V_{out1} - V_{out2} = 2V_{out}$  (V)

The output power is:

$$P_{out} = \frac{(2 V_{out_{RMS}})^2}{R_L} \text{ (W)}$$

For the same power supply voltage, the output power in BTL configuration is four times higher than the output power in single ended configuration.

#### ■ Gain In Typical Application Schematic (cf. page 1)

In flat region (no effect of  $C_{in}$ ), the output voltage of the first stage is:

$$V_{out1} = -V_{in} \frac{R_{feed}}{R_{in}} \text{ (V)}$$

For the second stage :  $V_{out2} = -V_{out1}$  (V)

The differential output voltage is:

$$V_{out2} - V_{out1} = 2V_{in} \frac{R_{feed}}{R_{in}} \text{ (V)}$$

The differential gain named gain ( $G_v$ ) for more convenient usage is:

$$G_v = \frac{V_{out2} - V_{out1}}{V_{in}} = 2 \frac{R_{feed}}{R_{in}}$$

Remark :  $V_{out2}$  is in phase with  $V_{in}$  and  $V_{out1}$  is 180 phased with  $V_{in}$ . It means that the positive terminal of the loudspeaker should be connected to  $V_{out2}$  and the negative to  $V_{out1}$ .

#### ■ Low and high frequency response

In low frequency region, the effect of  $C_{in}$  starts.  $C_{in}$  with  $R_{in}$  forms a high pass filter with a -3dB cut off frequency.

$$F_{CL} = \frac{1}{2\pi R_{in} C_{in}} \text{ (Hz)}$$

In high frequency region, you can limit the bandwidth by adding a capacitor ( $C_{feed}$ ) in parallel on  $R_{feed}$ . Its form a low pass filter with a -3dB cut off frequency.

$$F_{CH} = \frac{1}{2\pi R_{feed} C_{feed}} \text{ (Hz)}$$

#### ■ Power dissipation and efficiency

Hypothesis :

- Voltage and current in the load are sinusoidal ( $V_{out}$  and  $I_{out}$ )
- Supply voltage is a pure DC source ( $V_{cc}$ )

Regarding the load we have:

$$V_{OUT} = V_{PEAK} \sin \omega t \text{ (V)}$$

and

$$I_{OUT} = \frac{V_{OUT}}{R_L} \text{ (A)}$$

and

$$P_{OUT} = \frac{V_{PEAK}^2}{2R_L} \text{ (W)}$$

Then, the average current delivered by the supply voltage is:

$$I_{CC\text{ AVG}} = 2 \frac{V_{PEAK}}{\pi R_L} \text{ (A)}$$

The power delivered by the supply voltage is  
 $P_{supply} = V_{CC} I_{CC\text{ AVG}}$  (W)

Then, the **power dissipated by the amplifier** is  
 $P_{diss} = P_{supply} - P_{out}$  (W)

$$P_{diss} = \frac{2\sqrt{2}V_{CC}}{\pi\sqrt{R_L}} \sqrt{P_{OUT}} - P_{OUT} \text{ (W)}$$

and the maximum value is obtained when:

$$\frac{\partial P_{diss}}{\partial P_{OUT}} = 0$$

and its value is:

$$P_{diss\text{ max}} = \frac{2V_{CC}^2}{\pi^2 R_L} \text{ (W)}$$

Remark : This maximum value is only depending on power supply voltage and load values.

The **efficiency** is the ratio between the output power and the power supply

$$\eta = \frac{P_{OUT}}{P_{supply}} = \frac{\pi V_{PEAK}}{4V_{CC}}$$

The maximum theoretical value is reached when  $V_{peak} = V_{CC}$ , so

$$\frac{\pi}{4} = 78.5\%$$

#### ■ Decoupling of the circuit

Two capacitors are needed to bypass properly the TS4972, a power supply bypass capacitor  $C_s$  and a bias voltage bypass capacitor  $C_b$ .

$C_s$  has especially an influence on the THD+N in high frequency (above 7kHz) and indirectly on the power supply disturbances.

With 100 $\mu$ F, you can expect similar THD+N performances like shown in the datasheet.

If  $C_s$  is lower than 100 $\mu$ F, in high frequency increases, THD+N and disturbances on the power supply rail are less filtered.

To the contrary, if  $C_s$  is higher than 100 $\mu$ F, those disturbances on the power supply rail are more filtered.

$C_b$  has an influence on THD+N in lower frequency, but its function is critical on the final result of PSRR with input grounded in lower frequency.

If  $C_b$  is lower than 1 $\mu$ F, THD+N increase in lower frequency (see THD+N vs frequency curves) and the PSRR worsens up.

If  $C_b$  is higher than 1 $\mu$ F, the benefit on THD+N in lower frequency is small but the benefit on PSRR is substantial (see PSRR vs.  $C_b$  curve : fig.12).

Note that  $C_{in}$  has a non-negligible effect on PSRR in lower frequency. Lower is its value, higher is the PSRR (see fig. 13).

#### ■ Pop and Click performance

Pop and Click performance is intimately linked with the size of the input capacitor  $C_{in}$  and the bias voltage bypass capacitor  $C_b$ .

Size of  $C_{in}$  is due to the lower cut-off frequency and PSRR value requested. Size of  $C_b$  is due to THD+N and PSRR requested always in lower frequency.

Moreover,  $C_b$  determines the speed that the amplifier turns ON. The slower the speed is, the softer the turn ON noise is.

The charge time of  $C_b$  is directly proportional to the internal generator resistance 50k $\Omega$ .

Then, the charge time constant for  $C_b$  is

$$\tau_b = 50k\Omega \times C_b \text{ (s)}$$

As  $C_b$  is directly connected to the non-inverting input (pin 2 & 3) and if we want to minimize, in amplitude and duration, the output spike on  $V_{out1}$  (pin 5),  $C_{in}$  must be charged faster than  $C_b$ . The charge time constant of  $C_{in}$  is

$$\tau_{in} = (R_{in} + R_{feed}) \times C_{in} \text{ (s)}$$

Thus we have the relation  
 $\tau_{in} \ll \tau_b$  (s)

The respect of this relation permits to minimize the pop and click noise.

**Remark** : Minimize  $C_{in}$  and  $C_b$  has a benefit on pop and click phenomena but also on cost and size of the application.

**Example** : your target for the -3dB cut off frequency is 100 Hz. With  $R_{in}=R_{feed}=22\text{ k}\Omega$ ,  $C_{in}=72\text{ nF}$  (in fact 82nF or 100nF).

With  $C_b=1\mu\text{F}$ , if you choose the one of the latest two values of  $C_{in}$ , the pop and click phenomena at power supply ON or standby function ON/OFF will be very small

$50\text{ k}\Omega \times 1\mu\text{F} \gg 44\text{ k}\Omega \times 100\text{ nF}$  ( $50\text{ ms} \gg 4.4\text{ ms}$ ).

Increasing  $C_{in}$  value increases the pop and click phenomena to an unpleasant sound at power supply ON and standby function ON/OFF.

**Why  $C_s$  is not important in pop and click consideration ?**

Hypothesis :

- $C_s = 100\mu\text{F}$
- Supply voltage = 5V
- Supply voltage internal resistor =  $0.1\Omega$
- Supply current of the amplifier  $I_{cc} = 6\text{ mA}$

At power ON of the supply, the supply capacitor is charged through the internal power supply resistor. So, to reach 5V you need about five to ten times the charging time constant of  $C_s$  ( $\tau_s = 0.1 \times C_s$  (s)).

Then, this time equal  $50\mu\text{s}$  to  $100\mu\text{s} \ll \tau_b$  in the majority of application.

At power OFF of the supply,  $C_s$  is discharged by a constant current  $I_{cc}$ . The discharge time from 5V to 0V of  $C_s$  is:

$$\tau_{DischC_s} = \frac{5C_s}{I_{cc}} = 83\text{ ms}$$

Now, we must consider the discharge time of  $C_b$ . At power OFF or standby ON,  $C_b$  is discharged by a  $100\text{ k}\Omega$  resistor. So the discharge time is about  $\tau_{bDisch} \approx 3 \times C_b \times 100\text{ k}\Omega$  (s).

In the majority of application,  $C_b=1\mu\text{F}$ , then  $\tau_{bDisch} \approx 300\text{ ms} \gg \tau_{dischC_s}$ .

Power amplifier design examples

Given :

- Load impedance :  $8\Omega$
- Output power @ 1% THD+N : 0.5W
- Input impedance :  $10\text{ k}\Omega$  min.
- Input voltage peak to peak : 1Vpp
- Bandwidth frequency : 20Hz to 20kHz (0, -3dB)
- Ambient temperature max =  $50^\circ\text{C}$
- SO8 package

First of all, we must calculate the minimum power supply voltage to obtain 0.5W into  $8\Omega$ . With curves in fig. 15, we can read 3.5V. Thus, the power supply voltage value min. will be 3.5V.

Following the maximum power dissipation equation

$$P_{diss\max} = \frac{2V_{cc}^2}{\pi^2 R_L} \text{ (W)}$$

with 3.5V we have  $P_{diss\max}=0.31\text{ W}$ .

Refer to power derating curves (fig. 20), with 0.31W the maximum ambient temperature will be  $100^\circ\text{C}$ . This last value could be higher if you follow the example layout shown on the demoboard (better dissipation).

The gain of the amplifier in flat region will be:

$$G_V = \frac{V_{OUTPP}}{V_{INPP}} = \frac{2\sqrt{2}R_L P_{OUT}}{V_{INPP}} = 5.65$$

We have  $R_{in} > 10\text{ k}\Omega$ . Let's take  $R_{in} = 10\text{ k}\Omega$ , then  $R_{feed} = 28.25\text{ k}\Omega$ . We could use for  $R_{feed} = 30\text{ k}\Omega$  in normalized value and the gain will be  $G_V = 6$ .

In lower frequency we want 20 Hz (-3dB cut off frequency). Then:

$$C_{IN} = \frac{1}{2\pi R_{in} F_{CL}} = 795\text{ nF}$$

So, we could use for  $C_{in}$  a  $1\mu\text{F}$  capacitor value which gives 16Hz.

In Higher frequency we want 20kHz (-3dB cut off frequency). The Gain Bandwidth Product of the TS4972 is 2MHz typical and doesn't change when the amplifier delivers power into the load.

The first amplifier has a gain of:

$$\frac{R_{feed}}{R_{in}} = 3$$

and the theoretical value of the -3dB cut-off higher frequency is  $2\text{MHz}/3 = 660\text{kHz}$ .

We can keep this value or limit the bandwidth by adding a capacitor  $C_{\text{feed}}$ , in parallel on  $R_{\text{feed}}$ . Then:

$$C_{\text{FEED}} = \frac{1}{2\pi R_{\text{FEED}}F_{\text{CH}}} = 265\text{pF}$$

So, we could use for  $C_{\text{feed}}$  a 220pF capacitor value that gives 24kHz.

Now, we can calculate the value of  $C_b$  with the formula  $\tau_b = 50\text{k}\Omega \times C_b \gg \tau_{in} = (R_{in} + R_{\text{feed}}) \times C_{in}$  which permits to reduce the pop and click effects. Then  $C_b \gg 0.8\mu\text{F}$ .

We can choose for  $C_b$  a normalized value of  $2.2\mu\text{F}$  that gives good results in THD+N and PSRR.

In the following tables, you could find three another examples with values required for the demoboard.

#### Application n°1 : 20Hz to 20kHz bandwidth and 6dB gain BTL power amplifier

##### Components:

Designator	Part Type
R1	22k / 0.125W
R4	22k / 0.125W
R6	Short Circuit
R7	100k / 0.125W
R8	Short Circuit
C5	470nF
C6	100μF
C7	100nF
C9	Short Circuit
C10	Short Circuit
C12	1μF
S1, S2, S6, S7	2mm insulated Plug 10.16mm pitch
S8	3 pts connector 2.54mm pitch
P1	SMB Plug

#### Application n°2 : 20Hz to 20kHz bandwidth and 20dB gain BTL power amplifier

##### Components:

Designator	Part Type
R1	110k / 0.125W
R4	22k / 0.125W
R6	Short Circuit
R7	100k / 0.125W
R8	Short Circuit
C5	470nF
C6	100μF
C7	100nF
C9	Short Circuit
C10	Short Circuit
C12	1μF
S1, S2, S6, S7	2mm insulated Plug 10.16mm pitch
S8	3 pts connector 2.54mm pitch
P1	SMB Plug

#### Application n°3 : 50Hz to 10kHz bandwidth and 10dB gain BTL power amplifier

##### Components:

Designator	Part Type
R1	33k / 0.125W
R2	Short Circuit
R4	22k / 0.125W
R6	Short Circuit
R7	100k / 0.125W
R8	Short Circuit
C2	470pF
C5	150nF
C6	100μF
C7	100nF
C9	Short Circuit



Designator	Part Type
C10	Short Circuit
C12	1µF
S1, S2, S6, S7	2mm insulated Plug 10.16mm pitch
S8	3 pts connector 2.54mm pitch
P1	SMB Plug

**Application n°4 : Differential inputs BTL power amplifier**

In this configuration, we need to place these components : R1, R4, R5, R6, R7, C4, C5, C12.

We have also : R4 = R5, R1 = R6, C4 = C5.

The differential gain of the amplifier is:

$$G_{VDIFF} = 2 \frac{R1}{R4}$$

Note : Due to the VICM range (see Operating Condition), GVDIFF must have a minimum value shown in figure 84.

**Figure 84: Minimum Differential Gain vs Power Supply Voltage**

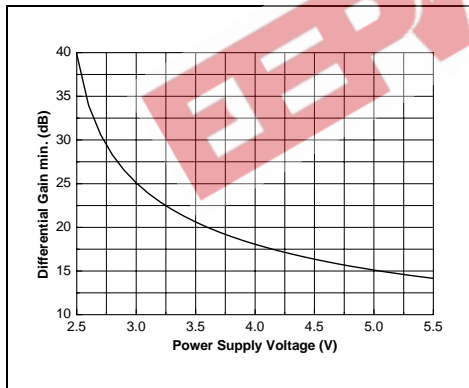

For Vcc=5V, a 20Hz to 20kHz bandwidth and 20dB gain BTL power amplifier you could follow the bill of material below.

**Components:**

Designator	Part Type
R1	110k / 0.125W
R4	22k / 0.125W
R5	22k / 0.125W
R6	110k / 0.125W
R7	100k / 0.125W
R8	Short circuit
C4	470nF
C5	470nF
C6	100µF
C7	100nF
C9	Short Circuit
C10	Short Circuit
C12	1µF
S1, S2, S6, S7	2mm insulated Plug 10.16mm pitch
S8	3 pts connector 2.54mm pitch
P1, P2	SMB Plug

**Note on how to use the PSRR curves (page 7)**

We have finished a design and we have chosen the components values :

- Rin=Rfeed=22kΩ
- Cin=100nF
- Cb=1μF

Now, on fig. 13, we can see the PSRR (input grounded) vs frequency curves. At 217Hz we have a PSRR value of -36dB.

In reality we want a value about -70dB. So, we need a gain of 34dB !

Now, on fig. 12 we can see the effect of Cb on the PSRR (input grounded) vs. frequency. With Cb=100μF, we can reach the -70dB value.

The process to obtain the final curve (Cb=100μF, Cin=100nF, Rin=Rfeed=22kΩ) is a simple transfer point by point on each frequency of the curve on fig. 13 to the curve on fig. 12.

The measurement result is shown on the next figure.

**Figure 85: PSRR changes with Cb**

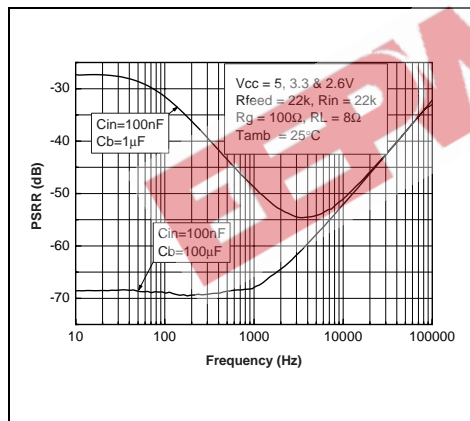

**Note on PSRR measurement**

What is the PSRR?

The PSRR is the Power Supply Rejection Ratio. It's a kind of SVR in a determined frequency range. The PSRR of a device, is the ratio between a power supply disturbance and the result on the output. We can say that the PSRR is the ability of a device to minimize the impact of power supply disturbances to the output.

How we measure the PSRR ?

**Figure 86: PSRR measurement schematic**

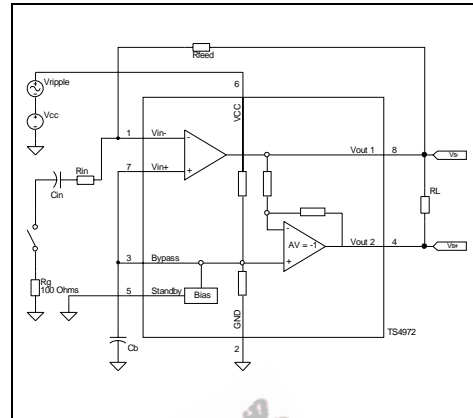

**Principle of operation**

- We fixed the DC voltage supply (Vcc)
- We fixed the AC sinusoidal ripple voltage (Vripple)
- No bypass capacitor Cs is used

The PSRR value for each frequency is:

$$PSRR(dB) = 20 \times \text{Log}_{10} \left[ \frac{Rms(V_{ripple})}{Rms(V_{s+} - V_{s-})} \right]$$

Remark : The measure of the Rms voltage is not a Rms selective measure but a full range (2 Hz to 125 kHz) Rms measure. It means that we measure the effective Rms signal + the noise.

4 Mechanical Data

Figure 87: TS4972 Footprint Recommendation (Non Solder Mask Defined)

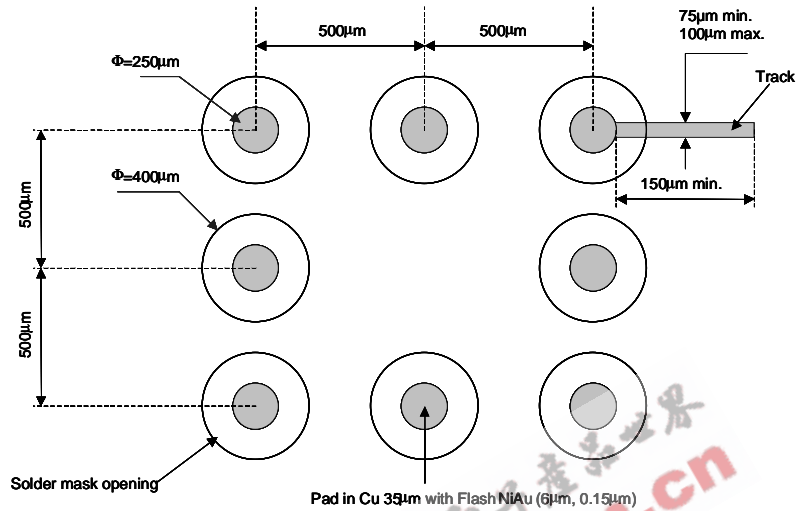
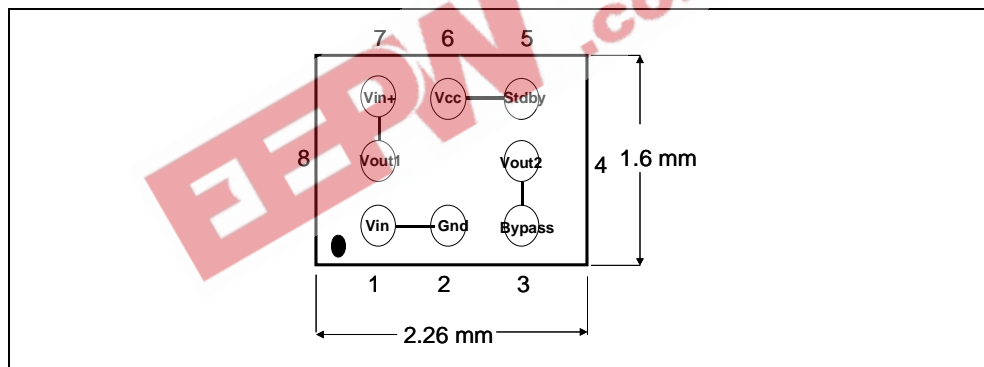

Figure 88: Top View Of The Daisy Chain Mechanical Data ( all drawings dimensions are in millimeters)



Remarks:

Daisy chain sample is featuring pins connection two by two. The schematic above is illustrating the way connecting pins each other. This sample is used for testing continuity on board. PCB needs to be designed on the opposite way, where pin connections are not done on daisy chain samples. By that way, just connecting an Ohmeter between pin 8 and pin 1, the soldering process continuity can be tested.

Order Codes

Part Number	Temperature Range	Package	Marking
		J	
TSDC03IJT	-40, +85°C	•	DC3

Figure 89: Tape & reel specification (top view)

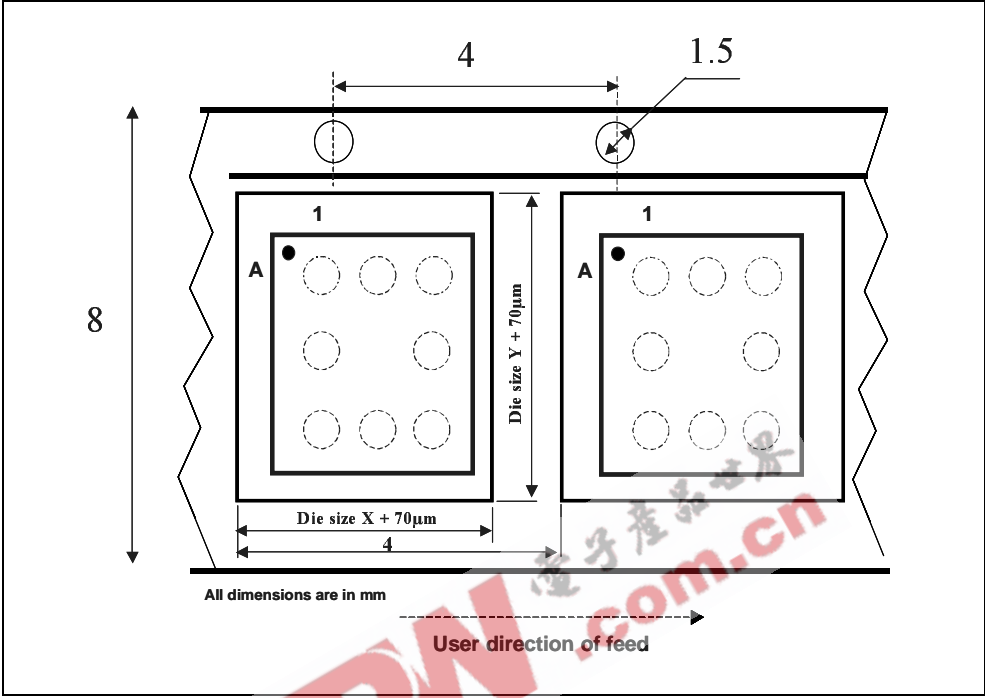

5 Package Mechanical Data

5.1 Flip-Chip - 8 BUMPS

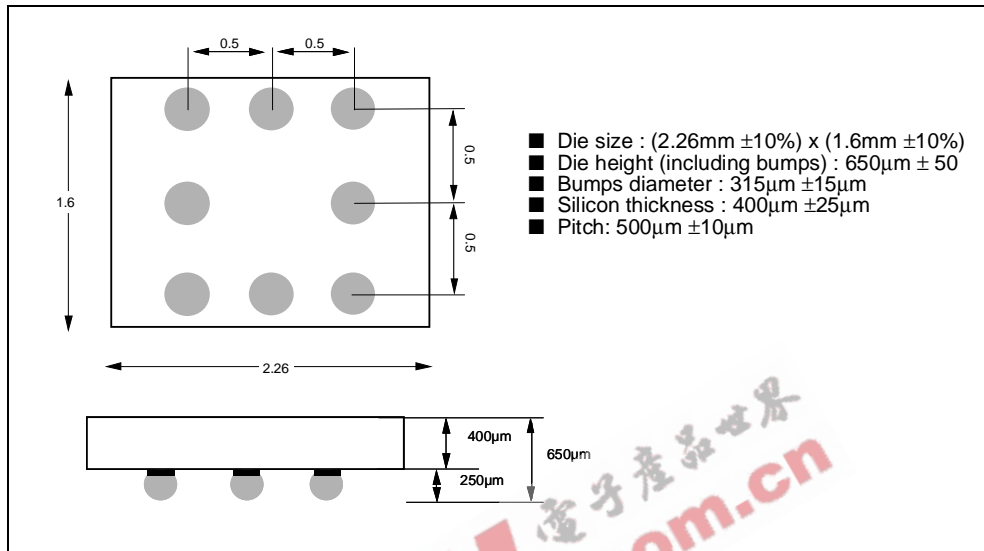
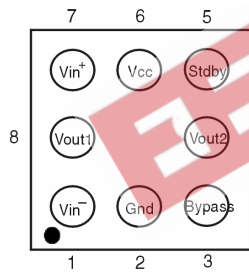

Figure 90: Pin Out (top view)

Figure 91: Marking (top view)



■ Balls are underneath



## Revision History

Date	Revision	Description of Changes
January 2003	1	First Release
October 2004	2	Update Mechanical Data for Flip-Chip package

EEPW 电子產品世界  
.com.cn

Information furnished is believed to be accurate and reliable. However, STMicroelectronics assumes no responsibility for the consequences of use of such information nor for any infringement of patents or other rights of third parties which may result from its use. No license is granted by implication or otherwise under any patent or patent rights of STMicroelectronics. Specifications mentioned in this publication are subject to change without notice. This publication supersedes and replaces all information previously supplied. STMicroelectronics products are not authorized for use as critical components in life support devices or systems without express written approval of STMicroelectronics.

The ST logo is a registered trademark of STMicroelectronics  
All other names are the property of their respective owners

© 2004 STMicroelectronics - All rights reserved

STMicroelectronics group of companies

Australia - Belgium - Brazil - Canada - China - Czech Republic - Finland - France - Germany - Hong Kong - India - Israel - Italy - Japan -  
Malaysia - Malta - Morocco - Singapore - Spain - Sweden - Switzerland - United Kingdom - United States of America  
[www.st.com](http://www.st.com)