

PRELIMINARY SPEC

Part Number: WP7104RWC/Z

WHITE



ATTENTION
OBSERVE PRECAUTIONS
FOR HANDLING
ELECTROSTATIC
DISCHARGE
SENSITIVE
DEVICES

Features

- LOW POWER CONSUMPTION.
- POPULAR T-1 DIAMETER PACKAGE.
- GENERAL PURPOSE LEADS.
- RELIABLE AND RUGGED.
- LONG LIFE - SOLID STATE RELIABILITY.
- AVAILABLE ON TAPE AND REEL.
- MOISTURE SENSITIVITY LEVEL : LEVEL 1.
- ELECTROSTATIC DISCHARGE THRESHOLD (HBM):1000V.
- TYP. COLOR TEMPERATURE:6500K.
- COLOR COORDINATES:X=0.33,Y=0.34 ACC. TO CIE1931(WHITE).
- OPTICAL EFFICIENCY: 46.9 lm/W(TYP.)
- COLOR REPRODUCTION INDEX:80.
- RoHS COMPLIANT.

Description

The source color devices are made with InGaN Light Emitting Diode.

Static electricity and surge damage the LEDs.

It is recommended to use a wrist band or anti-electrostatic glove when handling the LEDs.

All devices, equipment and machinery must be electrically grounded.

Applications

- Furniture lighting
- Outdoor displays
- Optical indicators
- Signal and symbol luminaire
- Marker lights (e.g. steps, exit ways, etc.)
- Lighting for special effects (e.g. starry sky)
- Substitute for miniature flashlight

Package Dimensions

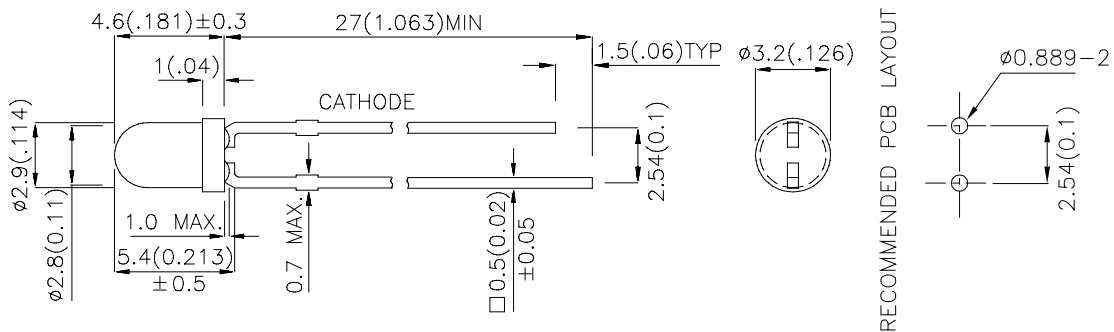

Notes:

1. All dimensions are in millimeters (inches).
2. Tolerance is $\pm 0.25(0.01)$ unless otherwise noted.
3. Lead spacing is measured where the leads emerge from the package.
4. Specifications are subject to change without notice.

Selection Guide

Part No.	Dice	Lens Type	Luminous Intensity ^{Note2} Iv(mcd) @ 20mA		Φ_V (mlm) ^{Note3} @ 20mA	Viewing Angle ^{Note1}
			Min.	Typ.	Typ.	2 θ 1/2
WP7104RWC/Z	WHITE (InGaN)	WATER CLEAR	2800	5500	3000	34°

Absolute Maximum Ratings at TA=25°C

Parameter	Symbol	Value	Unit
Power dissipation	Pt	111	mW
Reverse Voltage	VR	5	V
Junction temperature	TJ	110	°C
Operating Temperature	Top	-40 To +85	°C
Storage Temperature	Tstg	-40 To +100	°C
DC Forward Current	IF	30	mA
Peak Forward Current ^{Note4}	IFM	100	mA
Thermal resistance Junction/ambient ^{Note5}	Rth JA	350	°C/W
Junction/solder point	Rth JS	120	°C/W

Notes:

1. θ 1/2 is the angle from optical centerline where the luminous intensity is 1/2 the optical centerline value.
- 2.Luminous intensity is measured by a current pulse of 10ms at a tolerance of $\pm 15\%$.
- 3.The typical data of Luminous Flux can only reflect statistical figures, actual parameters of individual product could differ from the typical data.
For the purpose of product enhancement, the typical data is subject to change without prior notice.
- 4.1/10 Duty Cycle, 0.1ms Pulse Width.
- 5.Rth(J-A) Results from mounting on PC board FR4 (pad size $\geq 16 \text{ mm}^2$ per pad),

Electrical / Optical Characteristics at TA=25°C

Parameter	Symbol	Value	Unit
Chromaticity coordinate x acc.to CIE1931 IF=20mA [Typ.]	X ^{Note1}	0.33	-
Chromaticity coordinate y acc.to CIE1931 IF=20mA [Typ.]	Y ^{Note1}	0.34	-
Forward Voltage IF=20mA [Min.]	VF ^{Note2}	2.7	V
Forward Voltage IF=20mA [Typ.]		3.2	
Forward Voltage IF=20mA [Max.]		3.7	
Reverse Current (VR=5V) [Typ.]	IR	0.01	μA
Reverse Current (VR=5V) [Max.]		10	
Temperature coefficient of x IF=20mA, $-10^\circ\text{C} \leq T \leq 100^\circ\text{C}$ [Typ.]	TCx	-0.1	$10^{-3}/^\circ\text{C}$
Temperature coefficient of y IF=20mA, $-10^\circ\text{C} \leq T \leq 100^\circ\text{C}$ [Typ.]	TCy	-0.2	$10^{-3}/^\circ\text{C}$
Temperature coefficient of VF IF=20mA, $-10^\circ\text{C} \leq T \leq 100^\circ\text{C}$ [Typ.]	TCv	-2.5	mV/°C

Notes:

- 1.Chromaticity coordinates are measured by a current pulse of 20ms with a tolerance of ± 0.01 in X and Y color coordinates.
- 2.Forward voltage is measured with a current pulse of 10ms at a tolerance of $\pm 0.1V$.

Brightness codes

Code.	luminous Intensity ^{Note1} Iv(mcd) @ 20mA		Φ_v (mlm) ^{Note2} @ 20mA
	Min.	Max.	Typ.
ZA	2800	3800	1900
ZB	3300	4500	2200
ZC	3800	5500	2700
ZD	4700	6500	3200
ZE	5700	7500	3800
ZF	6700	8500	4400
ZG	7500	10000	5000
ZH	9000	11000	5800

Notes:

- 1.Luminous intensity is measured by a current pulse of 10ms at a tolerance of $\pm 15\%$.
- 2.The typical data of Luminous Flux can only reflect statistical figures, actual parameters of individual product could differ from the typical data. For the purpose of product enhancement, the typical data is subject to change without prior notice.

White

WP7104RWC/Z

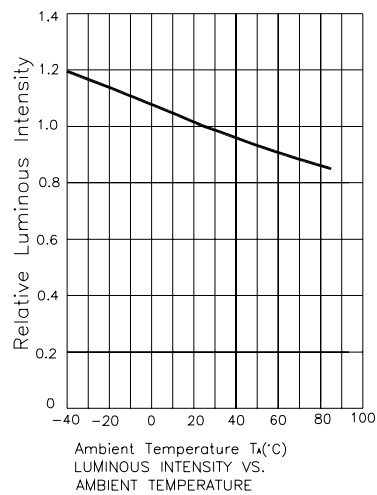
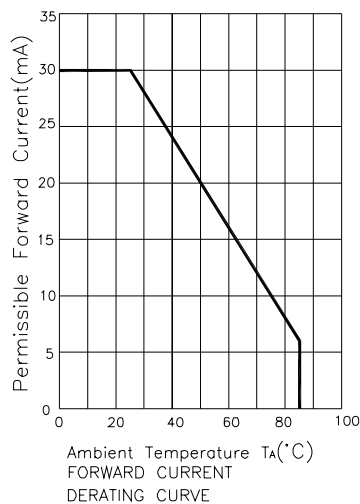
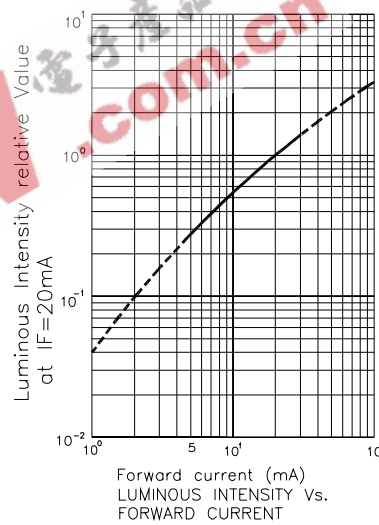
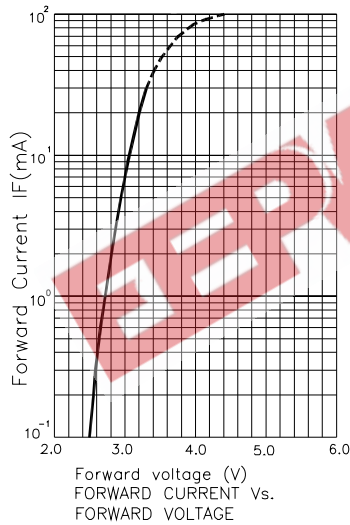

White

WP7104RWC/Z

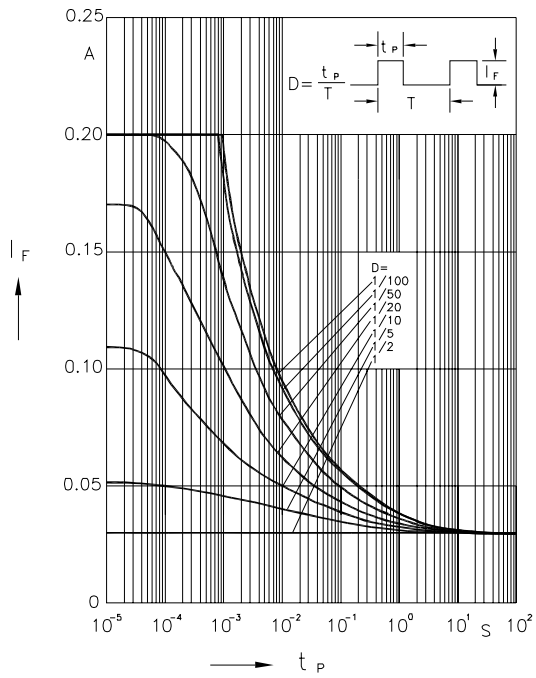

Permissible Pulse Handling Capability
Duty cycle $D = \text{parameter}$, $T_A = 25^\circ\text{C}$

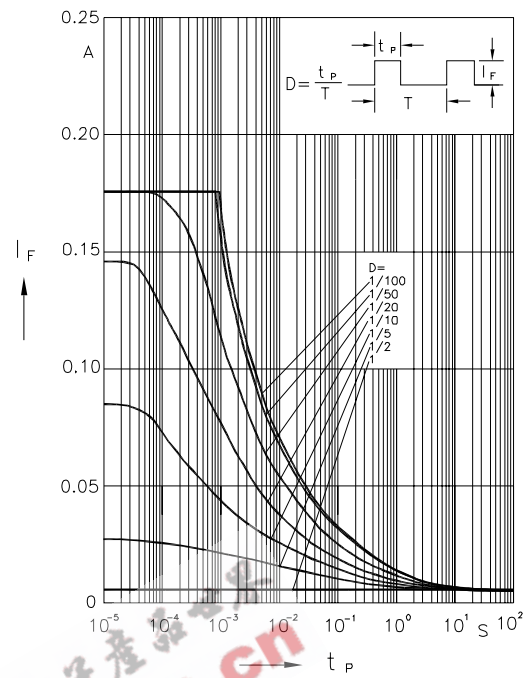

Permissible Pulse Handling Capability
Duty cycle $D = \text{parameter}$, $T_A = 85^\circ\text{C}$

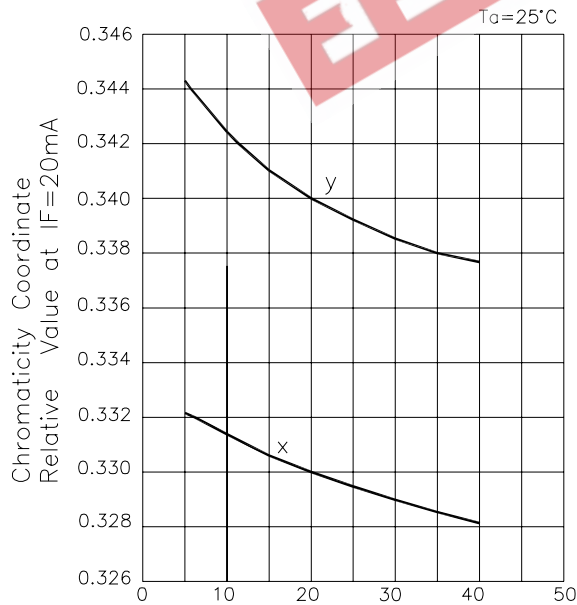

Forward Current (mA)
Chromaticity Coordinate Shift Vs.
Forward Current

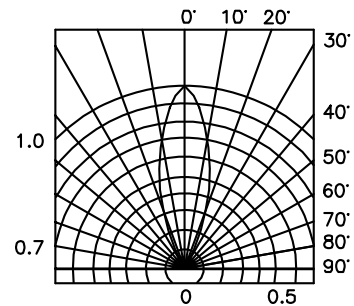
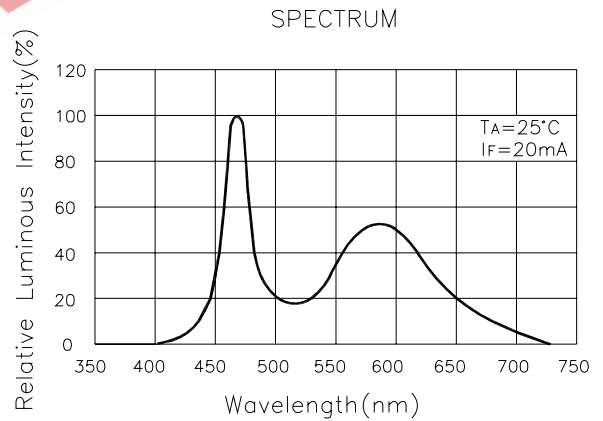

SPATIAL DISTRIBUTION

Color Codes

WP7104RWC/Z

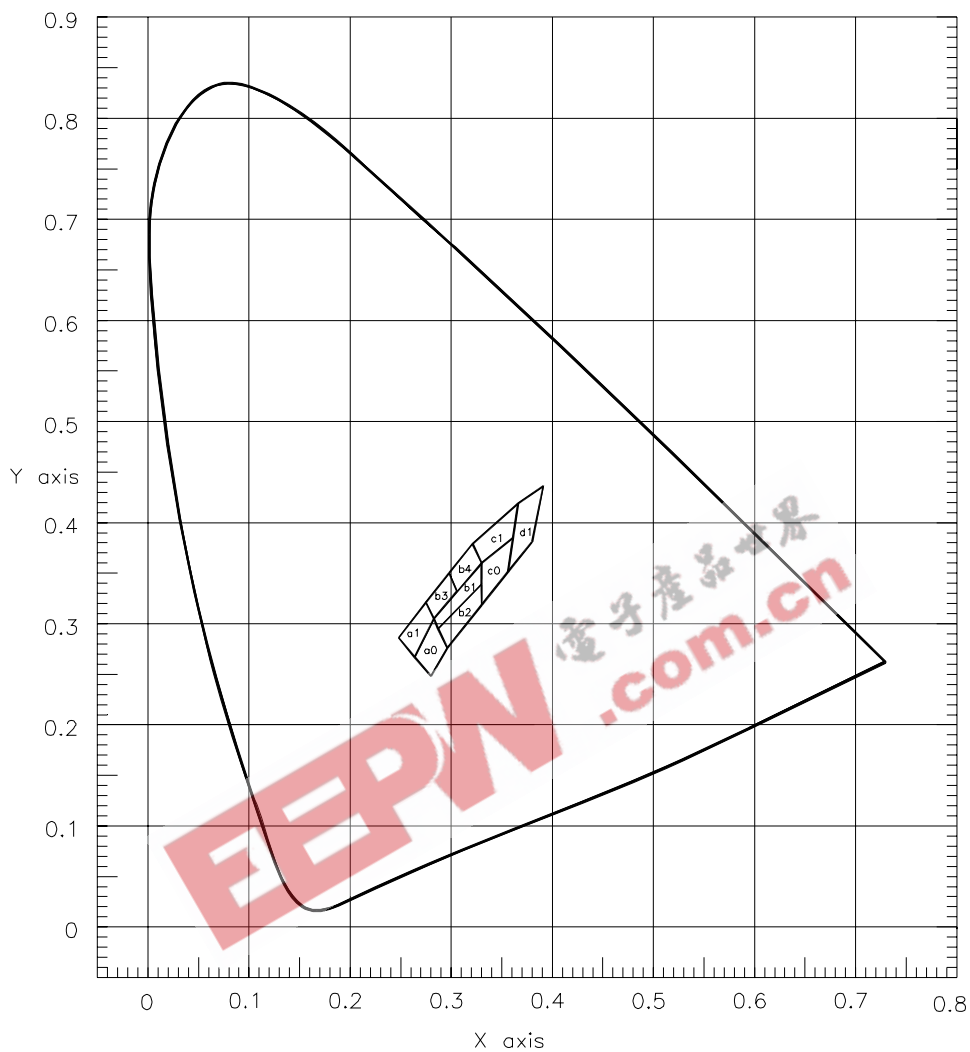

a1				
X	0.248	0.275	0.283	0.264
Y	0.286	0.321	0.305	0.267
b1				
X	0.283	0.330	0.330	0.287
Y	0.305	0.360	0.339	0.295
c1				
X	0.321	0.366	0.361	0.330
Y	0.379	0.419	0.385	0.360

a0				
X	0.264	0.283	0.296	0.280
Y	0.267	0.305	0.276	0.248
b2				
X	0.287	0.330	0.330	0.296
Y	0.295	0.339	0.318	0.276
c0				
X	0.330	0.361	0.356	0.330
Y	0.360	0.385	0.351	0.318

b3				
X	0.275	0.298	0.306	0.283
Y	0.321	0.350	0.332	0.305
b4				
X	0.298	0.321	0.330	0.306
Y	0.350	0.379	0.360	0.332
d1				
X	0.366	0.391	0.380	0.356
Y	0.419	0.436	0.381	0.351

Ta=25°, IF=20mA

Measurement Uncertainty of the Color Coordinates: +/-0.01

WP7104RWC/Z

Wave Soldering Profile For Lead-free Through-hole LED.

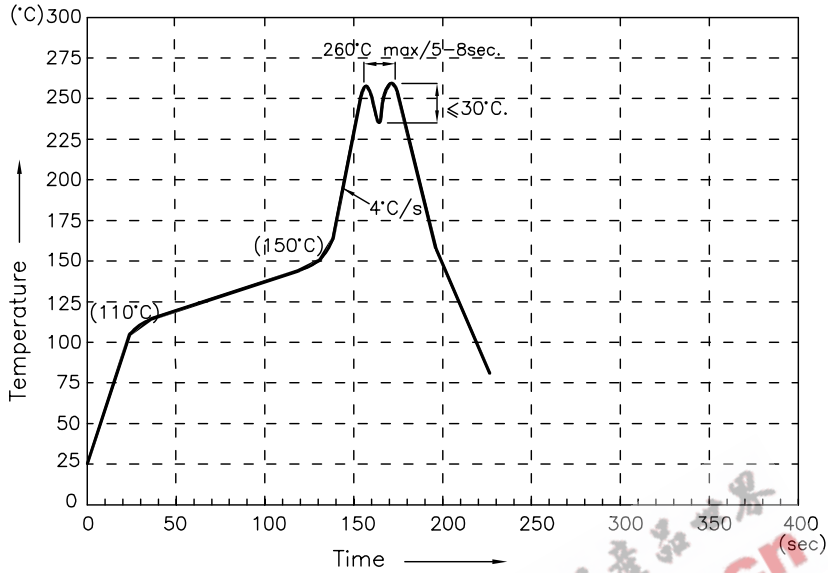

NOTES:

- 1.Recommend the wave temperature 245°C~260°C.The maximum soldering temperature should be less than 260°C.
- 2.Do not apply stress on epoxy resins when temperature is over 85 degree°C.
- 3.The soldering profile apply to the lead free soldering (Sn/Cu/Ag alloy).
- 4.No more than once.

Recommended Soldering Pattern
(Units : mm; Tolerance: ± 0.1)

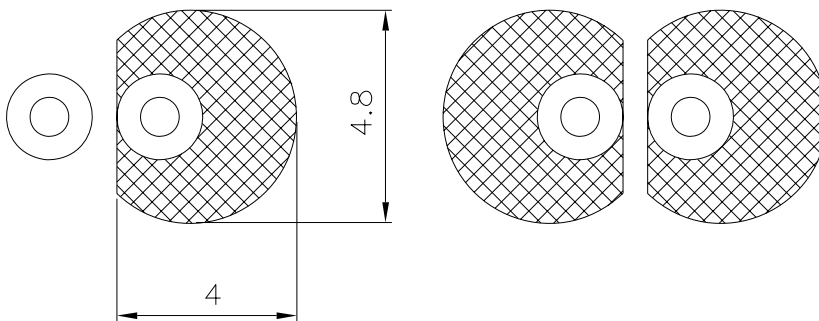

PACKING & LABEL SPECIFICATIONS

WP7104RWC/Z

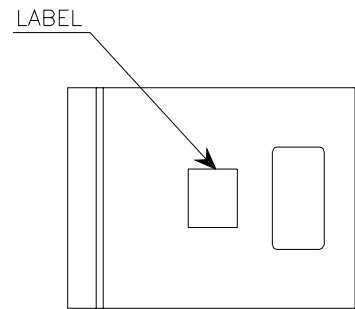
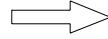
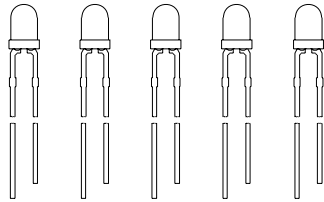

500PCS/BAG



20K / 9# BOX

OUTSIDE LABEL

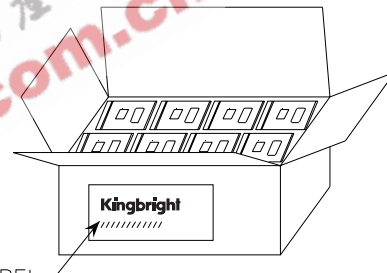

OUTSIDE LABEL

10K / 5# BOX

Kingbright				
Q.C.	<table border="1"> <tr> <td style="text-align: center;">QC</td> </tr> <tr> <td style="text-align: center;">xxx xx. xxxx</td> </tr> <tr> <td style="text-align: center;">PASSED</td> </tr> </table>	QC	xxx xx. xxxx	PASSED
QC				
xxx xx. xxxx				
PASSED				
TYPE NO : WP7104XXX				
QUANTITY : 500 pcs				
S/N : XXX	CODE: XX			
LOT NO : 				
RoHS Compliant				