

WP59SURKMGKW

HYPER RED
MEGA GREEN

Features

- UNIFORM LIGHT OUTPUT.
- LOW POWER CONSUMPTION.
- 3 LEADS WITH ONE COMMON LEAD.
- I.C. COMPATIBLE.
- LONG LIFE - SOLID STATE RELIABILITY.
- RoHS COMPLIANT.

Description

The Hyper Red source color devices are made with DH InGaAlP on GaAs substrate Light Emitting Diode.
The Mega Green source color devices are made with DH InGaAlP on GaAs substrate Light Emitting Diode.

Package Dimensions

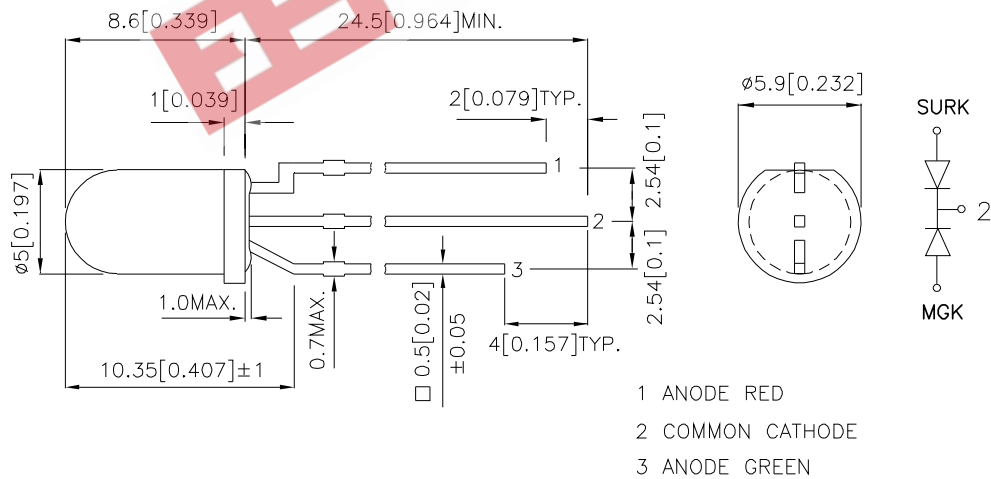

Notes:

1. All dimensions are in millimeters (inches).
2. Tolerance is ± 0.25 (0.01") unless otherwise noted.
3. Lead spacing is measured where the leads emerge from the package.
4. Specifications are subject to change without notice.

Selection Guide

Part No.	Dice	Lens Type	Iv (mcd) @ 20mA		Viewing Angle
			Min.	Typ.	2 θ 1/2
WP59SURKMGKW	HYPER RED (InGaAlP)	WHITE DIFFUSED	280	700	60°
	MEGA GREEN (InGaAlP)		50	170	

Note:

1. θ1/2 is the angle from optical centerline where the luminous intensity is 1/2 the optical centerline value.

Electrical / Optical Characteristics at TA=25°C

Symbol	Parameter	Device	Typ.	Max.	Units	Test Conditions
λ _{peak}	Peak Wavelength	Hyper Red Mega Green	650 574		nm	I _F =20mA
λ _D	Dominant Wavelength	Hyper Red Mega Green	635 570		nm	I _F =20mA
Δλ _{1/2}	Spectral Line Half-width	Hyper Red Mega Green	28 20		nm	I _F =20mA
C	Capacitance	Hyper Red Mega Green	35 15		pF	V _F =0V;f=1MHz
V _F	Forward Voltage	Hyper Red Mega Green	1.95 2.1	2.5 2.5	V	I _F =20mA
I _R	Reverse Current	All		10	uA	V _R = 5V

Absolute Maximum Ratings at TA=25°C

Parameter	Hyper Red	Mega Green	Units
Power dissipation	170	105	mW
DC Forward Current	30	30	mA
Peak Forward Current [1]	185	150	mA
Reverse Voltage	5	5	V
Operating/storage Temperature	-40°C To +85°C		
Lead Solder Temperature [2]	260°C For 3 Seconds		
Lead Solder Temperature [3]	260°C For 5 Seconds		

Notes:

1. 1/10 Duty Cycle, 0.1ms Pulse Width.
2. 2mm below package base.
3. 5mm below package base.

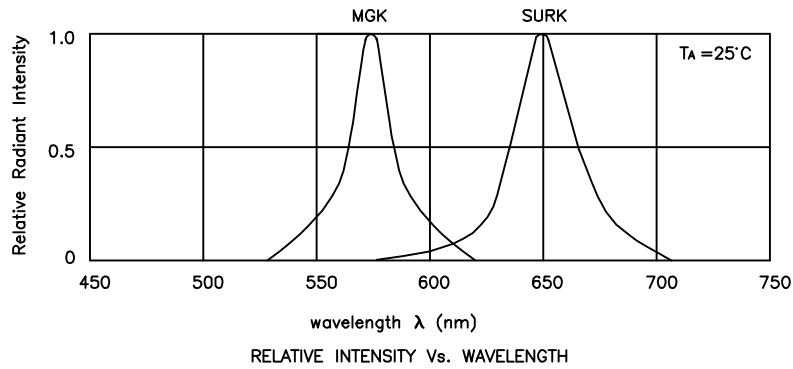

WP59SURKMGKW Hyper Red

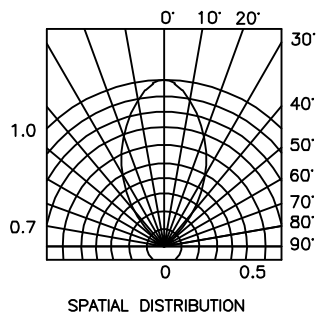
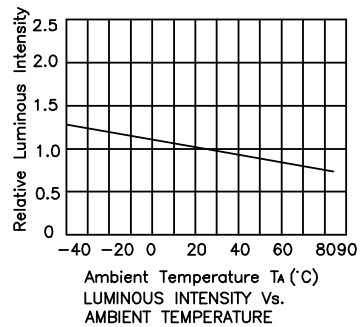
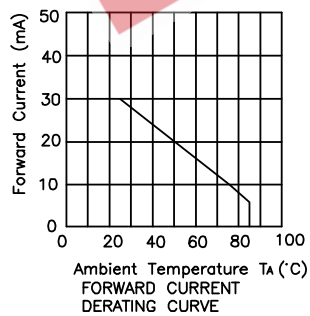
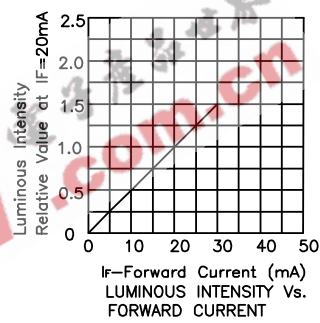
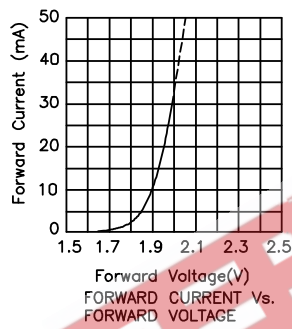

Kingbright

Mega Green

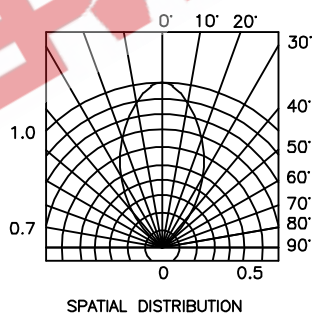
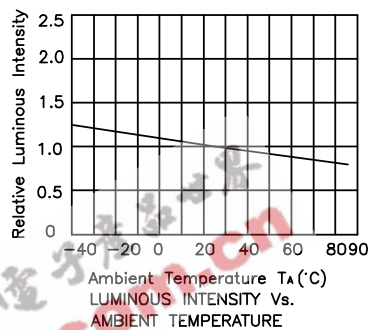
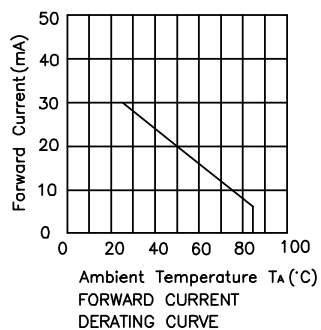
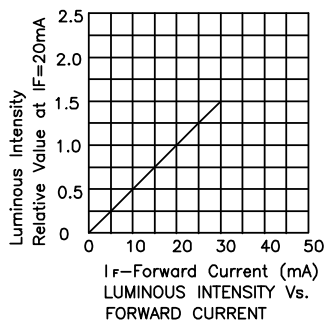
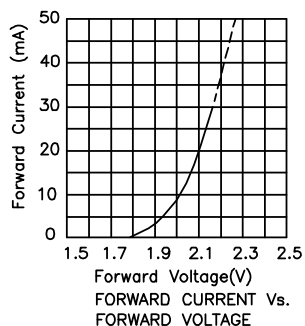

PACKING & LABEL SPECIFICATIONS

WP59SURKMGKW

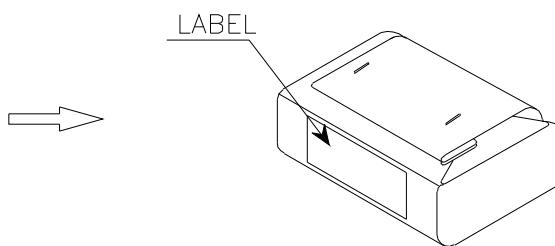
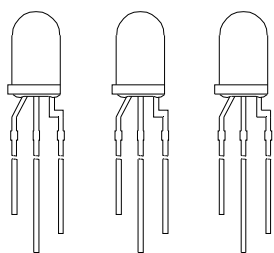

500PCS / BAG



28K / 9# BOX

OUTSIDE LABEL

OUTSIDE LABEL

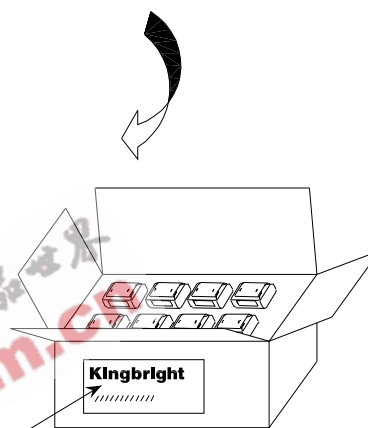

14K / 5# BOX

Kingbright	
Q.C.	QC xxx-xx-2005 PASSED
TYPE NO : WP59XXX	
QUANTITY : 500 pcs	
S/N : XXX	CODE: XX
LOT NO:  xxxxxxxxxx	
RoHS Compliant	

Remarks:

If special sorting is required (e.g. binning based on forward voltage, luminous intensity, or wavelength), the typical accuracy of the sorting process is as follows:

1. Wavelength: +/-1nm
2. Luminous Intensity: +/-15%
3. Forward Voltage: +/-0.1V

Note: Accuracy may depend on the sorting parameters.