



CHENMKO ENTERPRISE CO.,LTD

**1.5SCMJ
SERIES**

GLASS PASSIVATED JUNCTION TRANSIENT VOLTAGE SUPPRESSOR
VOLTAGE-6.8 TO 200 VOLTS
1500 WATTS PEAK POWER 6.5 WATTS STEADY STATE

Lead free devices

FEATURES

- * Plastic package
- * 1500W surge capability at 1ms
- * Glass passivated chip junction in SMC Package
- * Excellent clamping capability
- * Low Zener Impedance
- * Fast response time: typically less than 1.0ps from 0 volts to BV min.
- * Typical IR less than 1 uA above 10V
- * High temperature soldering guaranteed : 260°C/10 seconds at terminals

MECHANICAL DATA

Case: JEDEC SMC molded plastic
Terminals: Plated axial leads, solderable per MIL-STD-750, Method 2026
Polarity: Color band denotes cathode end
Mounting Position: Any
Weight: 0.007 ounce 0.25 gram



SMC

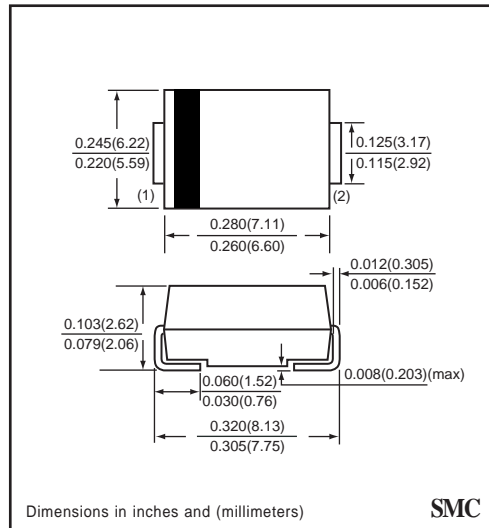

Dimensions in inches and (millimeters)

SMC

MAXIMUM RATINGS AND ELECTRICAL CHARACTERISTICS

Ratings at 25°C ambient temperature unless otherwise specified.
 Single phase, half wave, 60 Hz, resistive or inductive load.
 For capacitive load, derate current by 20%.

DEVICES FOR BIDIRECTIONAL APPLICATIONS

For Bidirectional use C or CA Suffix for types 1.5SCMJ6.8A thru types 1.5SCMJ200A
 Electrical characteristics apply in both directions.

MAXIMUM RATINGS (At TA = 25°C unless otherwise noted)

RATINGS	SYMBOL	VALUE	UNITS
Peak Power Dissipation at TA = 25°C, Tp = 1ms (Note1)	PPK	Minimum 1500	Watts
Steady State Power Dissipation at TL = 75°C	PD	6.5	Watts
Peak Forward Surge Current 8.3ms Single Half Sine-Wave Superimposed on Rated Load (Note 2)	IFSM	200	Amps
Operating and Storage Temperature Range	TJ, TSTG	-65 to +175	°C

NOTES : 1. Non-repetitive current pulse, per Fig. 3 and derated above TA = 25°C per Fig. 2.
 2. 8.3ms single half sine-wave, duty cycle = 4 pulses per minute maximum.
 3. P.C.B. mounted 0.31 x 0.31" (8 x 8mm) copper pad areas

2003-01

PRODUCT NO.	Breakdown Voltage				Working Peak Reverse Voltage	Maximum Reverse Leakage at Vrwm	Maximum Reverse Current (NOTE 2)	Maximum Reverse Voltage at Irsm (clamping)	Maximum Temperature Coefficient of Vbr
	VBR Volts (NOTE 1)			@ IT (mA)					
	MIN.	NOM.	MAX.		Vrwm (V)	Ir (uA)	Irsm (A)	Vrsm (V)	(%C)
1.5SCMJ6.8APT	6.45	6.8	7.14	10	5.80	1000	143	10.5	0.057
1.5SCMJ7.5APT	7.13	7.5	7.88	10	6.40	500	132	11.3	0.061
1.5SCMJ8.2APT	7.79	8.2	8.61	10	7.02	200	124	12.1	0.065
1.5SCMJ9.1APT	8.65	9.1	9.55	1.0	7.78	50	112	13.4	0.068
1.5SCMJ10APT	9.5	10	10.5	1.0	8.55	10	103	14.5	0.073
1.5SCMJ11APT	10.5	11	11.6	1.0	9.40	5.0	96.0	15.6	0.075
1.5SCMJ12APT	11.4	12	12.6	1.0	10.2	5.0	90.0	16.7	0.078
1.5SCMJ13APT	12.4	13	13.7	1.0	11.1	5.0	82.0	18.2	0.081
1.5SCMJ15APT	14.3	15	15.8	1.0	12.8	5.0	71.0	21.2	0.084
1.5SCMJ16APT	15.2	16	16.8	1.0	13.6	5.0	67.0	22.5	0.086
1.5SCMJ18APT	17.1	18	18.9	1.0	15.3	5.0	59.5	25.2	0.088
1.5SCMJ20APT	19.0	20	21.0	1.0	17.1	5.0	54.0	27.7	0.090
1.5SCMJ22APT	20.9	22	23.1	1.0	18.8	5.0	49.0	30.6	0.092
1.5SCMJ24APT	22.8	24	25.2	1.0	20.5	5.0	45.0	33.2	0.094
1.5SCMJ27APT	25.7	27	28.4	1.0	23.1	5.0	40.0	37.5	0.096
1.5SCMJ30APT	28.5	30	31.5	1.0	25.6	5.0	36.0	41.4	0.097
1.5SCMJ33APT	31.4	33	34.7	1.0	28.2	5.0	33.0	45.7	0.098
1.5SCMJ36APT	34.2	36	37.8	1.0	30.8	5.0	30.0	49.9	0.099
1.5SCMJ39APT	37.1	39	41.0	1.0	33.3	5.0	28.0	53.9	0.100
1.5SCMJ43APT	40.9	43	45.2	1.0	36.8	5.0	25.3	59.3	0.101
1.5SCMJ47APT	44.7	47	49.4	1.0	40.2	5.0	23.2	64.8	0.101
1.5SCMJ51APT	48.5	51	53.6	1.0	43.6	5.0	21.4	70.1	0.102
1.5SCMJ56APT	53.2	56	58.8	1.0	47.8	5.0	19.5	77.0	0.103
1.5SCMJ62APT	58.9	62	65.1	1.0	53.0	5.0	17.7	85.0	0.104
1.5SCMJ68APT	64.6	68	71.4	1.0	58.0	5.0	16.3	92.0	0.104
1.5SCMJ75APT	71.3	75	78.8	1.0	64.1	5.0	14.6	103	0.105
1.5SCMJ82APT	77.9	82	86.1	1.0	70.1	5.0	13.3	113	0.105
1.5SCMJ91APT	86.5	91	95.5	1.0	77.8	5.0	12.0	125	0.106
1.5SCMJ100APT	95.0	100	105	1.0	85.5	5.0	11.0	137	0.106
1.5SCMJ110APT	105	110	116	1.0	94.0	5.0	9.9	152	0.107
1.5SCMJ120APT	114	120	126	1.0	102	5.0	9.1	165	0.107
1.5SCMJ130APT	124	130	137	1.0	111	5.0	8.4	179	0.107
1.5SCMJ150APT	143	150	158	1.0	128	5.0	7.2	207	0.108
1.5SCMJ160APT	152	160	168	1.0	136	5.0	6.8	219	0.108
1.5SCMJ170APT	162	170	179	1.0	145	5.0	6.4	234	0.108
1.5SCMJ180APT	171	180	189	1.0	154	5.0	6.1	246	0.108
1.5SCMJ200APT	190	200	210	1.0	171	5.0	5.5	274	0.108

RATING CHARACTERISTIC CURVES (1.5SCMJ6.8APT ~ 1.5SCMJ200APT)

FIG. 1 - PULSE POWER RATING CURVE

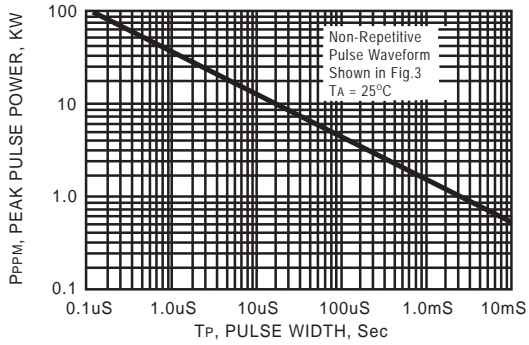

FIG. 2 - PULSE DERATING CURVE

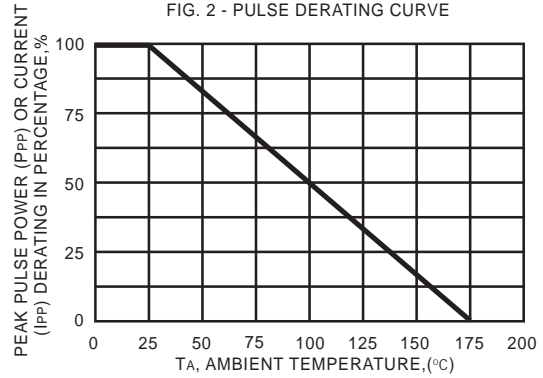

FIG. 3 - PULSE WAVEFORM

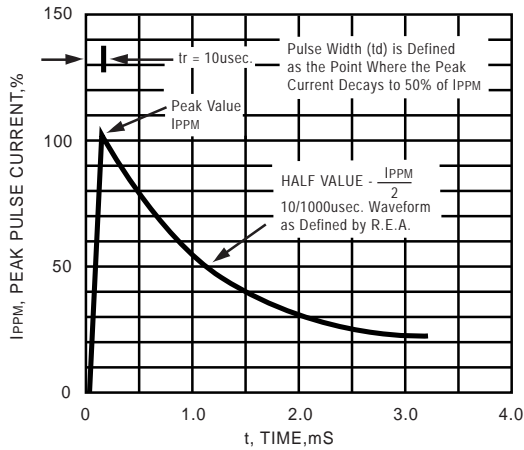

FIG. 4 - TYPICAL JUNCTION CAPACITANCE

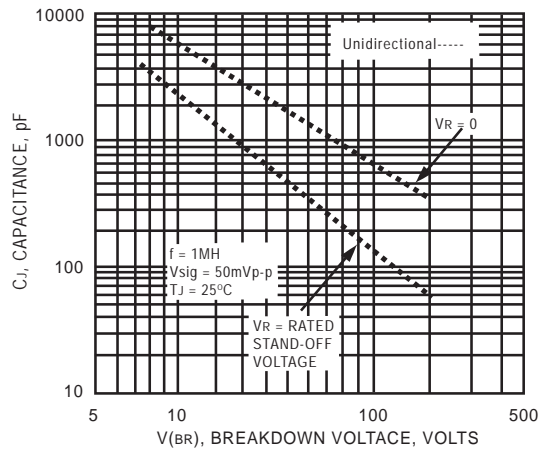

FIG. 5 - STEADY STATE POWER DERATING CURVE

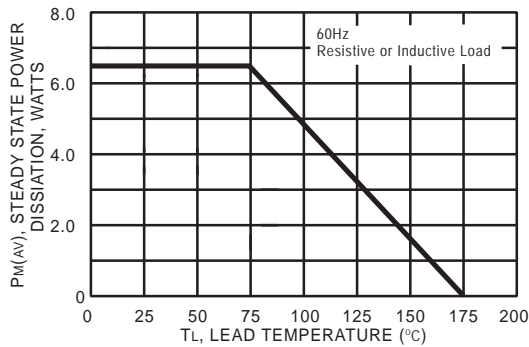
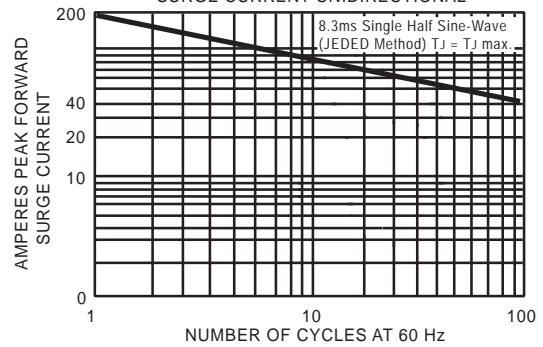

FIG. 6 - MAXIMUM NON-REPETITIVE FORWARD SURGE CURRENT UNIDIRECTIONAL



RATING CHARACTERISTIC CURVES (1.5SCMJ6.8APT ~ 1.5SCMJ200APT)

