

TRANSIENT VOLTAGE SUPPRESSOR

BREAKDOWN VOLTAGE: 6.8 --- 550 V
PEAK PULSE POWER: 1500 W

FEATURES

- ◇ Plastic package has underwriters laboratory flammability classification 94V-0
- ◇ Glass passivated junction
- ◇ 1500W peak pulse power capability with a 10/1000µs waveform, repetition rate (duty cycle): 0.01%
- ◇ Excellent clamping capability
- ◇ Low incremental surge resistance
- ◇ Fast response time: typically less than 1.0ps from 0 Volts to $V_{(BR)}$ for uni-directional and 5.0ns for bi-directional types
- ◇ For devices with $V_{(BR)} \geq 10V$, I_D are typically less than 5.0µA
- ◇ High temperature soldering guaranteed: 265 °C / 10 seconds, 0.375"(9.5mm) lead length, 5lbs. (2.3kg) tension

MECHANICAL DATA

- ◇ Case: JEDEC DO-201AE, molded plastic
- ◇ Polarity: color band denotes positive end (cathode) except for bidirectional
- ◇ Weight: 0.032 ounces, 0.9 grams
- ◇ Mounting position: any

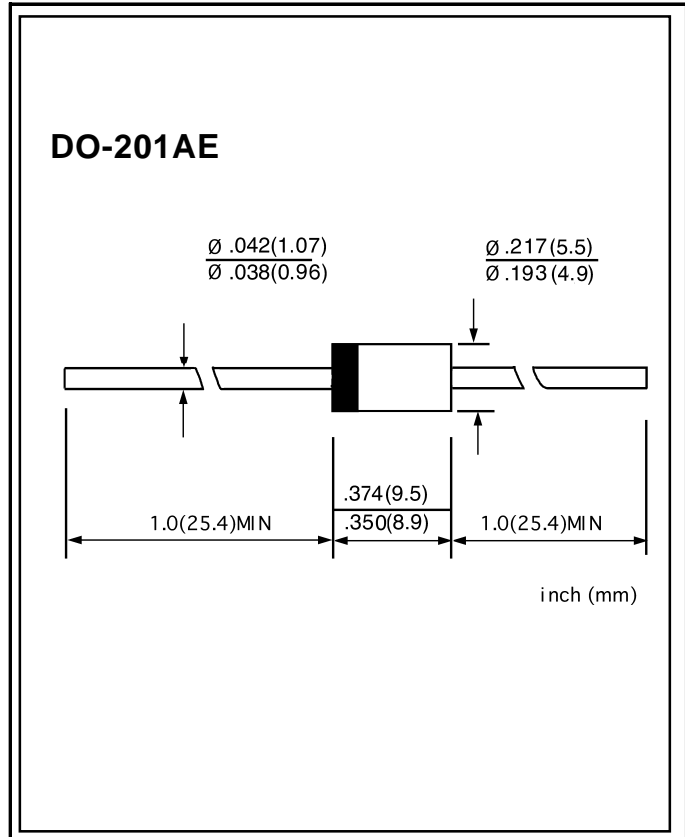

DEVICES FOR BIDIRECTIONAL APPLICATIONS

For bi-directional use C or CA suffix for types 1.5KE 6.8 thru types 1.5KE 550 (e.g. 1.5KE 6.8CA, 1.5KE 550CA).
 Electrical characteristics apply in both directions.

MAXIMUM RATINGS AND CHARACTERISTICS

Ratings at 25°C ambient temperature unless otherwise specified.

	SYMBOL	VALUE	UNIT
Peak power dissipation with a 10/1000µs waveform (NOTE 1, FIG.1)	P_{PPM}	Minimum 1500	W
Peak pulse current with a 10/1000µs waveform (NOTE 1)	I_{PPM}	SEE TABLE 1	A
Steady state power dissipation at $T_L=75^\circ\text{C}$ Lead lengths 0.375"(9.5mm) (NOTE 2)	$P_{M(AV)}$	6.5	W
Peak forward surge current, 8.3ms single half Sine-wave superimposed on rated load (JEDEC Method) (NOTE 3)	I_{FSM}	200.0	A
Maximum instantaneous forward voltage at 100.0A for unidirectional only (NOTE 4)	V_F	3.5/5.0	V
Operating junction and storage temperature range	T_J, T_{STG}	-50---+175	°C

NOTES: (1) Non-repetitive current pulses, per Fig. 3 and derated above $T_A=25^\circ\text{C}$ per Fig. 2

(2) Mounted on copper pad area of 1.6" x 1.6" (40 x 40mm²) per Fig. 5

(3) Measured of 8.3ms single half sine-wave or square wave, duty cycle=4 pulses per minute maximum

(4) $V_F=3.5$ Volt max. for devices of $V_{(BR)} \leq 200V$, and $V_F=5.0$ Volt max. for devices of $V_{(BR)} > 200V$

www.galaxycn.com

ELECTRICAL CHARACTERISTICS at(T_A=25 unless otherwise noted) TABLE 1

Device Type	Breakdown Voltage V _(BR) (V)(NOTE1)		Test Current at I _T (mA)	Stand-off Voltage V _{WM} (V)	Maximum Reverse Leakage at V _{WM} I _D (NOTE3)(μA)	Maximum Peak Pulse I _{PPM} (NOTE2) (A)	Maximum Clamping Voltage at I _{PPM} V _C (V)	Maximum Temperature Coefficient of V _(BR) (%/)
	MIN	MAX						
1.5KE 6.8	6.12	7.48	10.0	5.50	1000	139	10.8	0.057
1.5KE 6.8A	6.45	7.14	10.0	5.80	1000	143	10.5	0.057
1.5KE 7.5	6.75	8.25	10.0	6.05	500	128	11.7	0.061
1.5KE 7.5A	7.13	7.88	10.0	6.40	500	133	11.3	0.061
1.5KE 8.2	7.38	9.02	10.0	6.63	200	120	12.5	0.065
1.5KE 8.2A	7.79	8.61	10.0	7.02	200	124	12.1	0.065
1.5KE 9.1	8.19	10.0	1.0	7.37	50	109	13.8	0.068
1.5KE 9.1A	8.65	9.55	1.0	7.78	50	112	13.4	0.068
1.5KE 10	9.0	11.0	1.0	8.10	10	100	15.0	0.073
1.5KE 10A	9.5	10.5	1.0	8.55	10	103	14.5	0.073
1.5KE 11	9.9	12.1	1.0	8.92	5.0	92.6	16.2	0.075
1.5KE 11A	10.5	11.6	1.0	9.40	5.0	96.2	15.6	0.075
1.5KE 12	10.8	13.2	1.0	9.72	5.0	86.7	17.3	0.076
1.5KE 12A	11.4	12.6	1.0	10.2	5.0	89.8	16.7	0.078
1.5KE 13	11.7	14.3	1.0	10.5	5.0	78.9	19.0	0.081
1.5KE 13A	12.4	13.7	1.0	11.1	5.0	82.4	18.2	0.081
1.5KE 15	13.5	16.5	1.0	12.1	5.0	68.2	22.0	0.084
1.5KE 15A	14.3	15.8	1.0	12.8	5.0	70.8	21.2	0.084
1.5KE 16	14.4	17.6	1.0	12.9	5.0	63.8	23.5	0.086
1.5KE 16A	15.2	16.8	1.0	13.6	5.0	66.7	22.5	0.086
1.5KE 18	16.2	19.8	1.0	14.5	5.0	56.6	26.5	0.088
1.5KE 18A	17.1	18.9	1.0	15.3	5.0	59.5	25.2	0.089
1.5KE 20	18.0	22.0	1.0	16.2	5.0	51.5	29.1	0.090
1.5KE 20A	19.0	21.0	1.0	17.1	5.0	54.2	27.7	0.090
1.5KE 22	19.8	24.2	1.0	17.8	5.0	47.0	31.9	0.092
1.5KE 22A	20.9	23.1	1.0	18.8	5.0	49.0	30.6	0.092
1.5KE 24	21.6	26.4	1.0	19.4	5.0	43.2	34.7	0.094
1.5KE 24A	22.8	25.2	1.0	20.5	5.0	45.2	33.2	0.094
1.5KE 27	24.3	29.7	1.0	21.8	5.0	38.4	39.1	0.096
1.5KE 27A	25.7	28.4	1.0	23.1	5.0	40.0	37.5	0.096
1.5KE 30	27.0	33.0	1.0	24.3	5.0	34.5	43.5	0.097
1.5KE 30A	28.5	31.5	1.0	25.6	5.0	36.2	41.4	0.097
1.5KE 33	29.7	36.3	1.0	26.8	5.0	31.4	47.7	0.098
1.5KE 33A	31.4	34.7	1.0	28.2	5.0	32.8	45.7	0.098
1.5KE 36	32.4	39.6	1.0	29.1	5.0	28.8	52.0	0.099
1.5KE 36A	34.2	37.8	1.0	30.8	5.0	30.1	49.9	0.099
1.5KE 39	35.1	42.9	1.0	31.6	5.0	26.6	56.4	0.100
1.5KE 39A	37.1	41.0	1.0	33.3	5.0	27.8	53.9	0.100
1.5KE 43	38.7	47.3	1.0	34.8	5.0	24.2	61.9	0.101
1.5KE 43A	40.9	45.2	1.0	36.8	5.0	25.3	59.3	0.101
1.5KE 47	42.3	51.7	1.0	38.1	5.0	22.1	67.8	0.101
1.5KE 47A	44.7	49.4	1.0	40.2	5.0	23.1	64.8	0.101
1.5KE 51	45.9	56.1	1.0	41.3	5.0	20.4	73.5	0.102
1.5KE 51A	48.5	53.6	1.0	43.6	5.0	21.4	70.1	0.102
1.5KE 56	50.4	61.8	1.0	45.4	5.0	18.6	80.5	0.103
1.5KE 56A	53.2	58.8	1.0	47.8	5.0	19.5	77.0	0.103
1.5KE 62	55.8	68.2	1.0	50.2	5.0	16.9	89	0.104
1.5KE 62A	58.9	65.1	1.0	53.0	5.0	17.6	85	0.104
1.5KE 68	61.2	74.8	1.0	55.1	5.0	15.3	98	0.104
1.5KE 68A	64.6	71.4	1.0	58.1	5.0	16.3	92	0.104

www.galaxycn.com

ELECTRICAL CHARACTERISTICS at $T_A=25$ unless otherwise noted) TABLE 1(Cont' d)

Device Type	Breakdown Voltage $V_{(BR)}$ (V)(NOTE1)		Test Current at I_T (mA)	Stand-off Voltage $V_{WM}(V)$	Maximum Reverse Leakage at V_{WM} I_D (NOTE3)(μA)	Maximum Pead Pulse I_{PPM} (NOTE2) (A)	Maximum Clamping Voltage at I_{PPM} $V_C(V)$	Maximum Temperature Coefficient of $V_{(BR)}$ (%/)
	MIN	MAX						
1.5KE 75	67.5	82.5	1.0	60.7	5.0	13.9	109	0.105
1.5KE 75A	71.3	78.8	1.0	64.1	5.0	14.6	104	0.105
1.5KE 82	73.8	90.2	1.0	66.4	5.0	12.7	118	0.105
1.5KE 82A	77.9	86.1	1.0	70.1	5.0	13.3	113	0.105
1.5KE 91	81.9	100	1.0	73.7	5.0	11.5	131	0.106
1.5KE 91A	86.5	95.5	1.0	77.8	5.0	12.0	125	0.106
1.5KE 100	90.0	110	1.0	81.0	5.0	10.4	144	0.106
1.5KE 100A	95.0	105	1.0	85.5	5.0	10.9	137	0.106
1.5KE 110	99.0	121	1.0	89.2	5.0	9.5	158	0.107
1.5KE 110A	106	116	1.0	94.0	5.0	9.9	152	0.107
1.5KE 120	108	132	1.0	97.2	5.0	8.7	173	0.107
1.5KE 120A	114	126	1.0	102	5.0	9.1	165	0.107
1.5KE 130	117	143	1.0	106	5.0	8.0	187	0.107
1.5KE 130A	124	137	1.0	111	5.0	8.4	179	0.107
1.5KE 150	136	165	1.0	121	5.0	7.0	215	0.108
1.5KE 150A	143	158	1.0	128	5.0	7.2	207	0.106
1.5KE 160	144	176	1.0	130	5.0	6.5	230	0.106
1.5KE 160A	152	168	1.0	136	5.0	6.8	219	0.108
1.5KE 170	153	167	1.0	138	5.0	6.1	244	0.108
1.5KE 170A	162	179	1.0	145	5.0	6.4	234	0.108
1.5KE 180	162	198	1.0	146	5.0	5.8	258	0.108
1.5KE 180A	171	189	1.0	154	5.0	6.1	246	0.108
1.5KE 200	180	220	1.0	162	5.0	5.2	287	0.108
1.5KE 200A	190	210	1.0	171	5.0	5.5	274	0.108
1.5KE 220	196	242	1.0	175	5.0	4.4	344	0.108
1.5KE 220A	209	231	1.0	185	5.0	4.6	328	0.108
1.5KE 250	225	275	1.0	202	5.0	4.2	360	0.110
1.5KE 250A	237	263	1.0	214	5.0	4.4	344	0.110
1.5KE 300	270	330	1.0	243	5.0	3.5	430	0.110
1.5KE 300A	285	315	1.0	256	5.0	3.6	414	0.110
1.5KE 350	315	385	1.0	284	5.0	3.0	504	0.110
1.5KE 350A	333	368	1.0	300	5.0	3.1	482	0.110
1.5KE 400	360	440	1.0	324	5.0	2.6	574	0.110
1.5KE 400A	380	420	1.0	342	5.0	2.7	548	0.110
1.5KE 440	396	484	1.0	356	5.0	2.4	631	0.110
1.5KE 440A	418	462	1.0	376	5.0	2.5	602	0.110
1.5KE 480	432	528	1.0	389	5.0	2.19	686	0.110
1.5KE 480A	456	504	1.0	408	5.0	2.28	658	0.110
1.5KE 510	459	561	1.0	413	5.0	2.06	729	0.110
1.5KE 510A	485	535	1.0	434	5.0	2.15	698	0.110
1.5KE 540	486	594	1.0	437	5.0	1.94	772	0.110
1.5KE 540A	513	567	1.0	459	5.0	2.03	740	0.110
1.5KE 550	495	605	1.0	470	5.0	1.91	786	0.110
1.5KE 550A	522	577	1.0	467	5.0	2.00	760	0.110

NOTE:(1) Pulse test:tp 50ms

(2) Surge current waveform per Fig.3 and derate per Fig.2

www.galaxycn.com

FIG.1 – PEAK PULSE POWER RATING CURVE

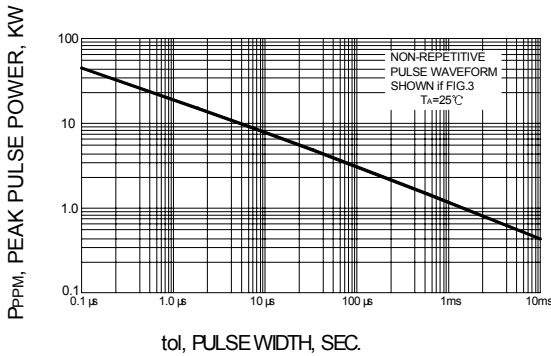

FIG.3 – PULSE WAVEFORM

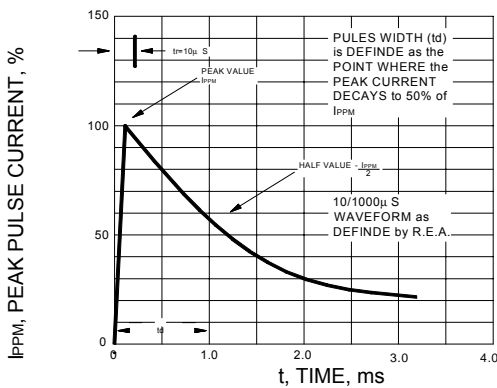

FIG.5 – STEADY STATE POWER DERATING CURVE

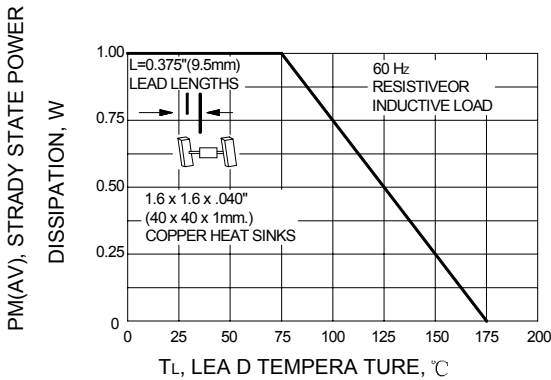

FIG.7 – TYPICAL REVERSE LEAKAGE CHARACTERISTICS

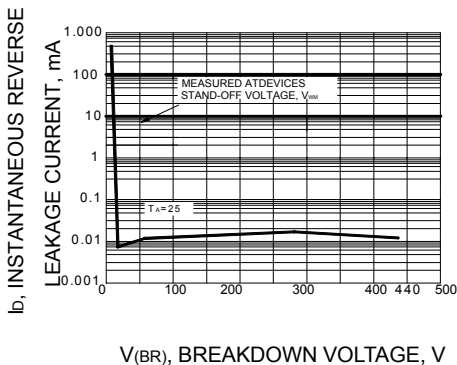

FIG.2 – PULSE DERATING CURVE

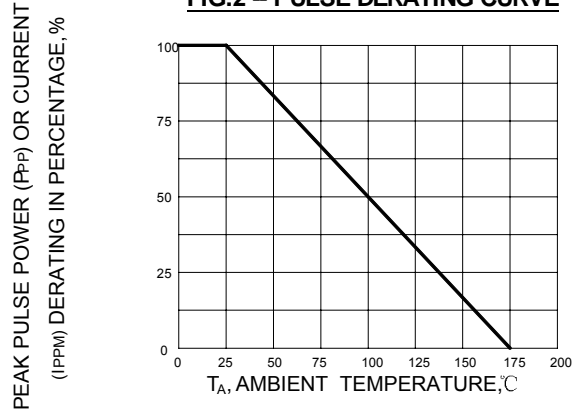

FIG.4 – TYPICAL JUNCTION CAPACITANCE UNIDIRECTIONAL

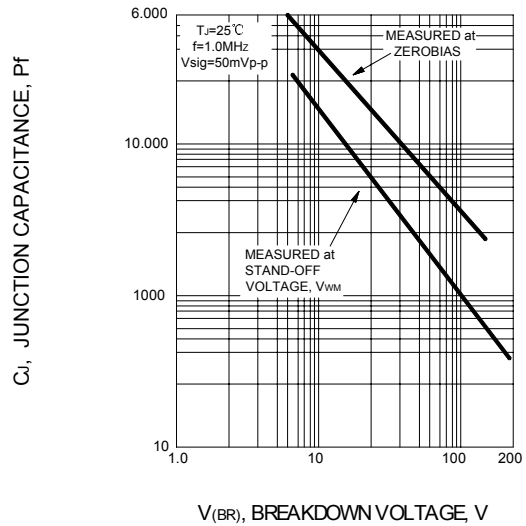

FIG.6 – MAXIMUM NON-REPETITIVE FORWARD SURGE CURRENT UNIDIRECTIONAL ONLY

