

T-1143

**MOTOROLA SEMICONDUCTOR TECHNICAL DATA**

**1N3821 thru 1N3830 SERIES**  
**1N3016 thru 1N3051 SERIES**

**Designers Data Sheet**

**1.0 WATT METAL SILICON ZENER DIODES**

... a complete series of 1.0 Watt Zener Diodes with limits and operating characteristics that reflect the superior capabilities of silicon-oxide-passivated junctions. All this in an axial-lead, metal package offering protection in all common environmental conditions.

- To 100 Watts Surge Rating @ 10 ms
- Maximum Limits Guaranteed on Five Electrical Parameters
- Power Capability to MIL-S-19500 Specifications

**Designer's Data for "Worst Case" Conditions**

The Designers Data sheets permit the design of most circuits entirely from the information presented. Limit curves — representing boundaries on device characteristics — are given to facilitate "worst case" design.

**1.0 WATT ZENER REGULATOR DIODES**  
3.3-200 VOLTS

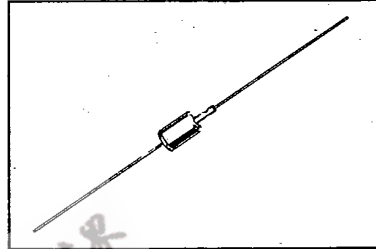

4

**\*MAXIMUM RATINGS**

Rating	Symbol	Value	Unit
DC Power Dissipation @ T <sub>A</sub> = 25°C Derate above 25°C (See Figure 1)	P <sub>D</sub>	1.0 6.67	Watt mW/°C
Operating and Storage Junction Temperature Range	T <sub>J</sub> , T <sub>stg</sub>	-65 to +175	°C

Lead Temperature 230°C at a distance not less than 1/16" from the case for 10 seconds.

**MECHANICAL CHARACTERISTICS**

**CASE:** Welded, hermetically sealed metal and glass.

**DIMENSIONS:** See outline drawing.

**FINISH:** All external surfaces are corrosion-resistant and leads are readily solderable and weldable.

**POLARITY:** Cathode connected to the case. When operated in zener mode, cathode will be positive with respect to anode.

**WEIGHT:** 1.4 Grams (approx)

**MOUNTING POSITION:** Any

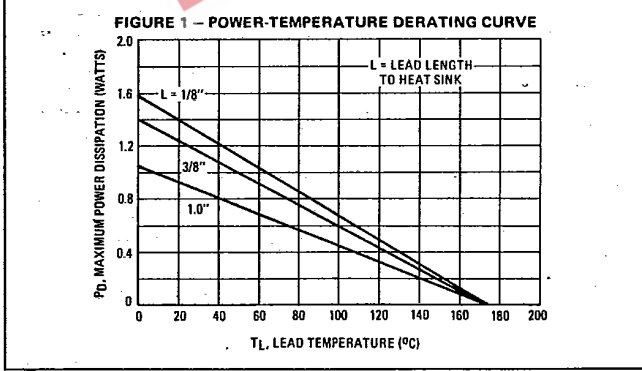
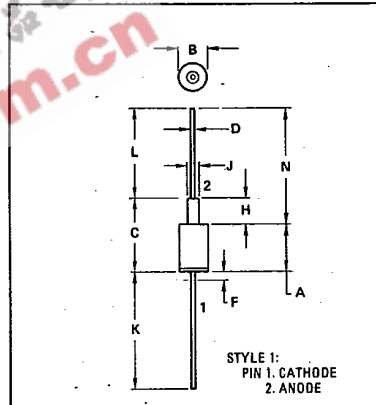

DIM	MILLIMETERS		INCHES	
	MIN	MAX	MIN	MAX
A	7.44	9.07	0.293	0.357
B	5.46	5.97	0.215	0.235
C	-	14.48	-	0.570
D	0.64	0.89	0.025	0.035
F	-	4.78	-	0.188
J	1.14	2.54	0.045	0.100
K	25.40	41.28	1.000	1.625
L	25.40	41.28	1.000	1.625

All JEDEC dimensions and notes apply

**CASE 52-03 DO-13 METAL**

NOTE:  
1. ALL RULES AND NOTES ASSOCIATED WITH DO-13 OUTLINE SHALL APPLY.

\*Indicates JEDEC Registered Data.

1N3821 thru 1N3830, 1N3016 thru 1N3051

T-11-13

ELECTRICAL CHARACTERISTICS (T<sub>C</sub> = 25°C unless otherwise noted)

V<sub>F</sub> = 1.5 V max @ I<sub>F</sub> = 200 mA for all types

JEDEC Type No. (Flangeless)	*Nominal Zener Voltage V <sub>Z</sub> @ I <sub>ZT</sub> (Note 1)	*Test Current I <sub>ZT</sub> mA	*Max Zener Impedance (Note 4)			Max Reverse Current (Note 6)			*Max DC Zener Current I <sub>ZM</sub> mA (Note 4)
			Z <sub>ZT</sub> @ I <sub>ZT</sub> Ohms	Z <sub>ZK</sub> @ I <sub>ZK</sub> Ohms	I <sub>ZK</sub> mA	I <sub>R</sub> Max (μA)	VR1 5%	VR2 10%	
1N3821	3.3	76	10	400	1.0	*100	*1.0	1.0	276
1N3822	3.6	69	10	400	1.0	*100	*1.0	1.0	252
1N3823	3.9	64	9.0	400	1.0	*50	*1.0	1.0	238
1N3824	4.3	58	9.0	400	1.0	*10	*1.0	1.0	213
1N3825	4.7	53	8.0	600	1.0	*10	*1.0	1.0	194
1N3826	5.1	49	7.0	550	1.0	*10	*1.0	1.0	178
1N3827	5.6	45	5.0	600	1.0	*10	*2.0	2.0	162
1N3828	6.2	41	2.0	700	1.0	*10	*3.0	3.0	146
1N3829	6.8	37	1.6	500	1.0	*10	*3.0	3.0	133
1N3830	7.5	34	1.5	250	1.0	*10	*3.0	3.0	121
1N3016	6.8	37	3.5	700	1.0	10	5.2	4.9	140
1N3017	7.5	34	4.0	700	0.5	10	5.7	5.4	125
1N3018	8.2	31	4.5	700	0.5	10	6.2	5.9	115
1N3019	9.1	28	5.0	700	0.5	7.5	6.9	6.6	105
1N3020	10	25	7.0	700	0.25	5.0	7.6	7.2	95
1N3021	11	23	8.0	700	0.25	5.0	8.4	8.0	85
1N3022	12	21	9.0	700	0.25	2.0	9.1	8.6	80
1N3023	13	19	10	700	0.25	1.0	9.9	9.4	74
1N3024	15	17	14	700	0.25	1.0	11.4	10.8	63
1N3025	16	15.5	16	700	0.25	1.0	12.2	11.5	50
1N3026	18	14	20	750	0.25	0.5	13.7	13.0	52
1N3027	20	12.5	22	750	0.25	0.5	15.2	14.4	47
1N3028	22	11.5	23	750	0.25	0.5	16.7	15.8	43
1N3029	24	10.5	25	750	0.25	0.5	18.2	17.3	40
1N3030	27	9.5	35	750	0.25	0.5	20.6	19.4	34
1N3031	30	8.5	40	1000	0.25	0.5	22.8	21.6	31
1N3032	33	7.5	45	1000	0.25	0.5	25.1	23.8	28
1N3033	36	7.0	50	1000	0.25	0.5	27.4	26.9	26
1N3034	39	6.5	60	1000	0.25	0.5	29.7	28.1	23
1N3035	43	6.0	70	1500	0.25	0.5	32.7	31.0	21
1N3036	47	5.5	80	1500	0.25	0.5	35.8	33.8	19
1N3037	51	5.0	95	1500	0.25	0.5	38.8	36.7	18
1N3038	55	4.5	110	2000	0.25	0.5	42.6	40.3	17
1N3039	62	4.0	125	2000	0.25	0.5	47.1	44.6	15
1N3040	68	3.7	150	2000	0.25	0.5	51.7	49.0	14
1N3041	75	3.3	175	2000	0.25	0.5	56.0	54.0	12
1N3042	82	3.0	200	3000	0.25	0.5	62.2	59.0	11
1N3043	91	2.8	250	3000	0.25	0.5	69.2	65.5	10
1N3044	100	2.5	350	3000	0.25	0.5	76.0	72.0	9.0
1N3045	110	2.3	450	4000	0.25	0.5	83.6	79.2	8.3
1N3046	120	2.0	550	4500	0.25	0.5	91.2	86.4	8.0
1N3047	130	1.9	700	5000	0.25	0.5	98.8	93.6	6.9
1N3048	150	1.7	1000	6500	0.25	0.5	114.0	108.0	5.7
1N3049	160	1.6	1100	6500	0.25	0.5	121.6	115.2	5.4
1N3050	180	1.4	1200	7000	0.25	0.5	136.8	129.6	4.9
1N3051	200	1.2	1500	8000	0.25	0.5	152.0	144.0	4.6

\* JEDEC Registered Data on 1N3821 thru 1N3830 and 1N3016 thru 1N3051

## 1N3821 thru 1N3830, 1N3016 thru 1N3051

T-11-13

Example: 1M7.5AZZ10

**NOTE 1 - ZENER VOLTAGE ( $V_Z$ ) MEASUREMENT**

Motorola guarantees the zener voltage when measured at 90 seconds while maintaining the lead temperature ( $T_L$ ) at  $30^\circ\text{C} \pm 1^\circ\text{C}$ ,  $3/8''$  from the diode body.

**NOTE 2 - ZENER IMPEDANCE ( $Z_Z$ ) DERIVATION**

The zener impedance is derived from the 60 cycle ac voltage, which results when an ac current having an rms value equal to 10% of the dc zener current ( $I_{ZT}$  or  $I_{ZK}$ ) is superimposed on  $I_{ZT}$  or  $I_{ZK}$ .

**NOTE 3 - REVERSE LEAKAGE CURRENT  $I_R$** 

Reverse leakage currents are guaranteed only for 5% and 10% zener diodes and are measured at  $V_R$  as shown in the Electrical Characteristics Table.

**NOTE 4 - MAXIMUM ZENER CURRENT RATINGS ( $I_{ZM}$ )**

1N3821 thru 1N3830 - Maximum zener current ratings are based on maximum voltage of 10% tolerance units.

1N3016 thru 1N3051 - Maximum zener current ratings are based on maximum voltage of 5% tolerance units.

**NOTE 5 - SURGE CURRENT ( $I_s$ )**

Surge current is specified as the maximum allowable peak, non-recurrent square-wave current with a specified pulse width, PW. The data presented in Figures 8 and 9 may be used to find the maximum surge current for a square wave of any pulse width between 0.01 ms and 1000 ms.

**APPLICATION NOTE**

Since the actual voltage available from a given zener diode is temperature dependent, it is necessary to determine junction temperature under any set of operating conditions in order to calculate its value. The following procedure is recommended:

Lead Temperature,  $T_L$ , should be determined from:

$$T_L = \theta_{LA} P_D + T_A$$

$\theta_{LA}$  is the lead-to-ambient thermal resistance ( $^\circ\text{C}/\text{W}$ ) and  $P_D$  is the power dissipation. The value for  $\theta_{LA}$  will vary and depends on the device mounting method.  $\theta_{LA}$  is generally 30-40 $^\circ\text{C}/\text{W}$  for the various clips and tie points in common use and for printed circuit board wiring.

The temperature of the lead can also be measured using a thermocouple placed on the lead as close as possible to the tie point. The thermal mass connected to the tie point is normally large enough so that it will not significantly respond to heat surges generated in the diode as a result of pulsed operation once steady-state conditions are achieved. Using the measured value of  $T_L$ , the junction temperature may be determined by:

$$T_J = T_L + \Delta T_{JL}$$

$\Delta T_{JL}$  is the increase in junction temperature above the lead temperature and may be found from Figure 6 for a train of power pulses ( $L = 3/8$  inch) or from Figure 7 for dc power.

$$\Delta T_{JL} = \theta_{JL} P_D$$

For worst-case design, using expected limits of  $I_Z$ , limits of  $P_D$  and the extremes of  $T_J(\Delta T_{JL})$  may be estimated. Changes in voltage,  $V_Z$ , can then be found from:

$$\Delta V = \theta_{VZ} \Delta T_J$$

$\theta_{VZ}$ , the zener voltage temperature coefficient, is found from Figures 2 and 3.

Under high power-pulse operation, the zener voltage will vary with time and may also be affected significantly by the zener resistance. For best regulation, keep current excursions as low as possible.

Data of Figure 6 should not be used to compute surge capability. Surge limitations are given in Figure 8. They are lower than would be expected by considering only junction temperature, as current crowding effects cause temperatures to be extremely high in small spots resulting in device degradation should the limits of Figure 8 be exceeded.

T-11-13

TEMPERATURE COEFFICIENTS AND VOLTAGE REGULATION  
 (90% OF THE UNITS ARE IN THE RANGES INDICATED)

FIGURE 2 - TEMPERATURE COEFFICIENT-RANGE  
 FOR UNITS TO 12 VOLTS

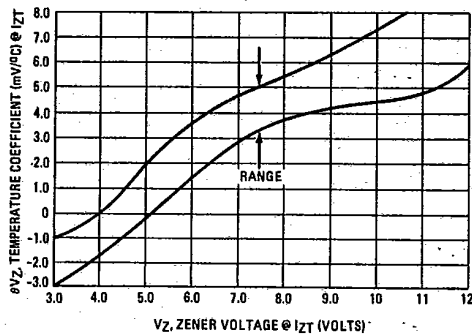

FIGURE 3 - TEMPERATURE COEFFICIENT-RANGE  
 FOR UNITS 10 TO 220 VOLTS

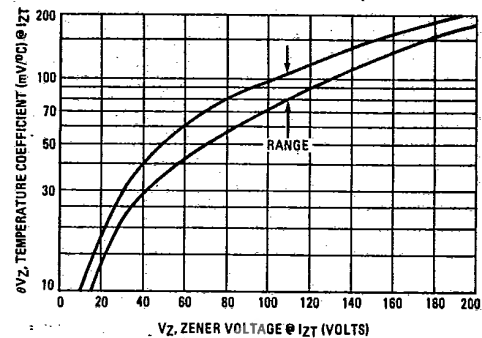

FIGURE 4 - TYPICAL VOLTAGE REGULATION

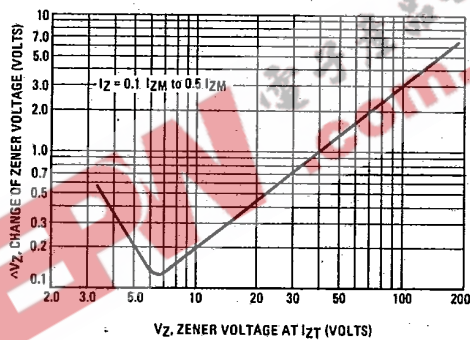

FIGURE 5 - MAXIMUM REVERSE LEAKAGE  
 (95% OF THE UNITS ARE BELOW THE VALUES SHOWN)

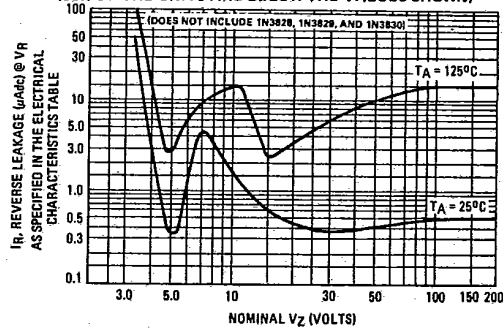

FIGURE 6 - TYPICAL THERMAL RESPONSE L, LEAD LENGTH = 3/8 INCH

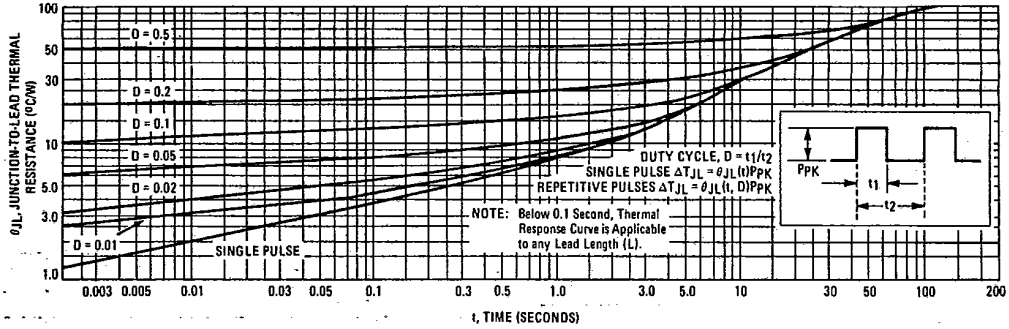

FIGURE 7 - TYPICAL THERMAL RESISTANCE

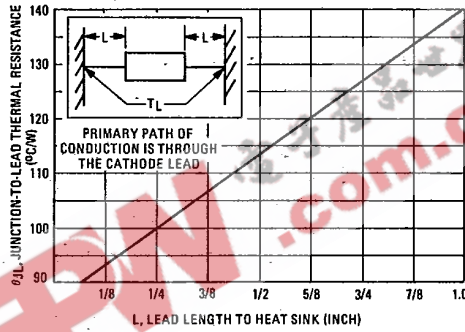
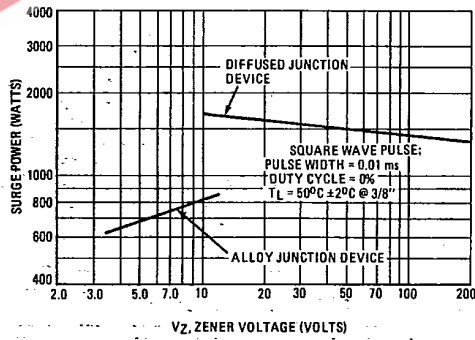

FIGURE 8 - MAXIMUM NON-REPETITIVE SURGE CURRENT



1N3821 thru 1N3830, 1N3016 thru 1N3051

T-11-13

FIGURE 9 - SURGE POWER FACTOR

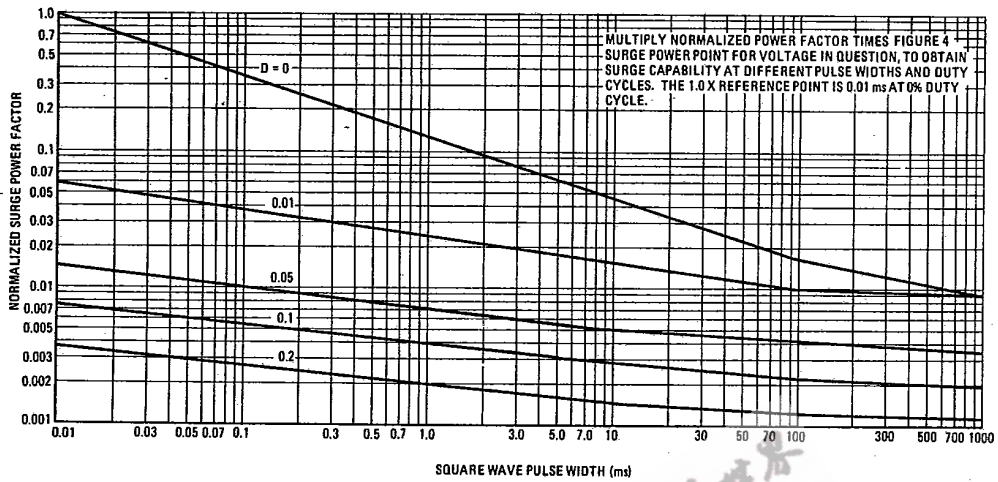

4

FIGURE 10 - TYPICAL CAPACITANCE

