

Microsemi Corp.
The diode experts

SANTA ANA, CA

SCOTTSDALE, AZ

For more information call:
(602) 941-6300

**1N6036
thru
1N6072A**

FEATURES

- 1500 WATTS PEAK POWER DISSIPATION
- AVAILABLE IN STANDOFF VOLTAGES FROM 5.5V TO 185V
- DO-13 HERMETICALLY SEALED PACKAGE
- BIDIRECTIONAL
- UL RECOGNIZED (1N6070A)
- JAN/TX/TXV AVAILABLE PER MIL-S-19500/507

DESCRIPTION

These TAZ devices are a series of Bidirectional Silicon Transient Suppressors used in AC applications where large voltage transients can permanently damage voltage-sensitive components.

These devices are manufactured using two silicon PN, low voltage junction in a back to back configuration. They are characterized by their high surge capability, extremely fast response time, and low impedance, (R_{on}).

TAZ has a peak pulse power rating of 1500 watts for one millisecond and therefore can be used in applications where induced lightning on rural or remote transmission lines represents a hazard to electronic circuitry. The response time of TAZ clamping action is less than (5×10^{-9}) sec; therefore, they can protect Integrated Circuits, MOS devices, Hybrids, and other voltage-sensitive semi-conductors and components.

This series of devices has been proven very effective as EMP Suppressors.

MAXIMUM RATINGS

- 1500 watts of peak pulse power dissipation at 25°C
- $t_{clamping}$ (0 volts to $V_{(BR)}$ min): less than 5×10^{-9} seconds
- Operating and storage temperatures -65°C to +175°C
- Steady state power dissipation: 1.0 watts at $T_L = 25^\circ C$, 3/8" from body.
- Repetition rate (duty cycle): .01%

ELECTRICAL CHARACTERISTICS

Clamping Factor: 1.33 @ full rated power
1.20 @ 50% rated power

Clamping Factor: The ratio of the actual V_C (Clamping Voltage) to the $V_{(BR)}$ (Breakdown Voltage) as measured on a specific device.

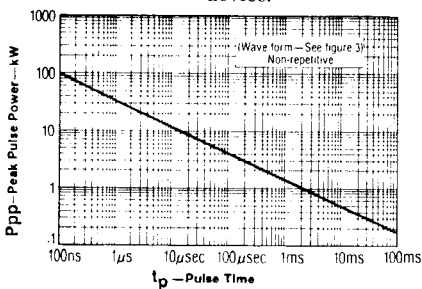

FIGURE 1

PEAK PULSE POWER VS. PULSE TIME

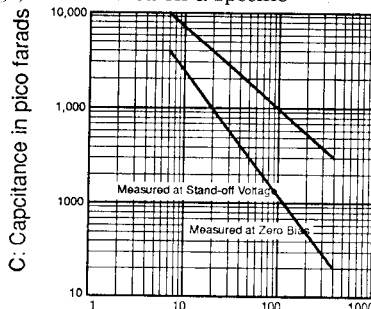
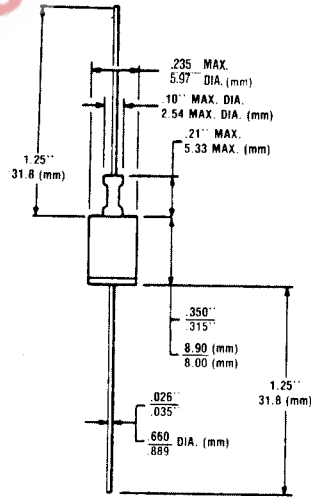

FIGURE 2 TYPICAL CAPACITANCE vs. BREAKDOWN VOLTAGE

**BIDIRECTIONAL
TRANSIENT
ABSORPTION ZENER**



MECHANICAL CHARACTERISTICS

- Standard DO-13 package, glass and metal hermetically sealed
- WEIGHT: 1.5 grams (approximate)
- FINISH: All external surfaces are corrosion resistant and leads solderable.
- POLARITY: Bidirectional not marked.
- MOUNTING POSITION: Any.

1N6036 thru 1N6072A

ELECTRICAL CHARACTERISTICS @ 25°C (Test Both Polarities)

JEDEC Type Number	Rated Stand-off Voltage (Note 1)	Breakdown Voltage			Maximum Clamping Voltage @ I _{pp} (1 mSEC)	Maximum Reverse Leakage @ V _{RM}	Maximum Peak Pulse Current (Fig. 2)	Maximum Temperature Coefficient of V _{BR}
	V _{RM} Volts	V(BR) Volts	@ I _T mA	V _C Volts	I _{RM} μA	I _{pp} A	α V _Z %/°C	
1N6036	5.5	6.75	- 8.25	10	11.7	1000	128	.061
*1N6036A	6.0	7.13	- 7.88	10	11.3	1000	132	.061
1N6037	6.5	7.38	- 9.02	10	12.5	500	120	.065
*1N6037A	7.0	7.79	- 8.61	10	12.1	500	124	.065
1N6038	7.0	8.19	- 10.00	10	13.8	200	109	.068
*1N6038A	7.5	8.65	- 9.55	10	13.4	200	112	.068
1N6039	8.0	9.0	- 11.0	1	15.0	50	100	.073
*1N6039A	8.5	9.5	- 10.5	1	14.5	50	103	.073
1N6040	8.5	9.9	- 12.1	1	16.2	10	93	.075
*1N6040A	9.0	10.5	- 11.6	1	15.6	10	96	.075
1N6041	9.0	10.8	- 13.2	1	17.3	5	87	.078
*1N6041A	10.0	11.4	- 12.6	1	16.7	5	90	.078
1N6042	10.0	11.7	- 14.3	1	19.0	5	79	.081
*1N6042A	11.0	12.4	- 13.7	1	18.2	5	82	.081
1N6043	11.0	13.5	- 16.5	1	22.0	5	68	.084
*1N6043A	12.0	14.3	- 15.8	1	21.2	5	71	.084
1N6044	12.0	14.4	- 17.5	1	23.5	5	64	.086
*1N6044A	13.0	15.2	- 16.8	1	22.5	5	67	.088
1N6045	14.0	16.2	- 19.8	1	26.5	5	56.5	.088
*1N6045A	15.0	17.1	- 18.9	1	25.2	5	59.5	.088
1N6046	16.0	18.0	- 22.0	1	29.1	5	51.5	.090
*1N6046A	17.0	19.0	- 21.0	1	27.7	5	54	.090
1N6047	17.0	19.8	- 24.2	1	31.9	5	47	.092
*1N6047A	18.0	20.9	- 23.1	1	30.6	5	49	.092
1N6048	19.0	21.6	- 26.4	1	34.7	5	43	.094
*1N6048A	20.0	22.8	- 25.2	1	33.2	5	45	.094
1N6049	21.0	24.3	- 29.7	1	39.1	5	38.5	.095
*1N6049A	22.0	25.7	- 28.4	1	37.5	5	40	.096
1N6050	24.0	27.0	- 33.0	1	43.5	5	34.5	.097
*1N6050A	25.0	28.5	- 31.5	1	41.4	5	36	.097
1N6051	26.0	29.7	- 36.3	1	47.7	5	31.5	.098
*1N6051A	28.0	31.4	- 34.7	1	45.7	5	33	.098
1N6052	29.0	32.4	- 39.6	1	52.0	5	29	.099
*1N6052A	30.0	34.2	- 37.8	1	49.9	5	30	.099
1N6053	31.0	35.1	- 42.9	1	56.4	5	26.5	.100
*1N6053A	33.0	37.1	- 41.0	1	53.9	5	28	.100
1N6054	34.0	38.7	- 47.3	1	61.9	5	24	.101
*1N6054A	36.0	40.9	- 45.2	1	59.3	5	25.3	.101
1N6055	38.0	42.3	- 51.7	1	67.8	5	22.2	.101
*1N6055A	40.0	44.7	- 49.4	1	64.8	5	23.2	.101
1N6056	41.0	45.9	- 56.1	1	73.5	5	20.4	.102
*1N6056A	43.0	48.5	- 53.6	1	70.1	5	21.4	.102
1N6057	45.0	50.4	- 61.6	1	80.5	5	18.6	.103
*1N6057A	47.0	53.2	- 58.8	1	77.0	5	19.5	.103
1N6058	48.0	55.8	- 68.2	1	89.0	5	16.9	.104
*1N6058A	53.0	58.9	- 65.1	1	85.0	5	17.7	.104
1N6059	55.0	61.2	- 74.8	1	98.0	5	15.3	.104
*1N6059A	58.0	64.6	- 71.4	1	92.0	5	16.3	.104
1N6060	60.0	67.5	- 82.5	1	108.0	5	13.9	.105
*1N6060A	64.0	71.3	- 78.8	1	103.0	5	14.6	.105
1N6061	66.0	73.8	- 90.2	1	118.0	5	12.7	.105
*1N6061A	70.0	77.9	- 86.1	1	113.0	5	13.3	.105
1N6062	73.0	81.9	- 100.0	1	131.0	5	11.4	.106
*1N6062A	75.0	86.5	- 95.5	1	125.0	5	12.0	.106
1N6063	81.0	90.0	- 110.0	1	144.0	5	10.4	.106
*1N6063A	82.0	95.0	- 105.0	1	137.0	5	11.0	.106
1N6064	90.0	99.0	- 121.0	1	158.0	5	9.5	.107
*1N6064A	94.0	105.0	- 116.0	1	152.0	5	9.9	.107
1N6065	95.0	103.0	- 132.0	1	176.0	5	8.5	.107
*1N6065A	100.0	114.0	- 126.0	1	168.0	5	8.9	.107
1N6066	105.0	117.0	- 143.0	1	191.0	5	7.8	.107
*1N6066A	110.0	124.0	- 137.0	1	182.0	5	8.2	.107
1N6067	121.0	135.0	- 165.0	1	223.0	5	6.7	.108
*1N6067A	128.0	143.0	- 159.0	1	213.0	5	7.0	.108
1N6068	137.0	153.0	- 187.0	1	258.0	5	5.8	.108
*1N6068A	145.0	162.0	- 179.0	1	245.0	5	6.1	.108
1N6069	145.0	162.0	- 198.0	1	274.0	5	5.5	.108
*1N6069A	150.0	171.0	- 189.0	1	261.0	5	5.7	.108
1N6070	155.0	171.0	- 210.0	1	292.0	5	5.1	.108
*1N6070A	160.0	181.0	- 200.0	1	278.0	5	5.4	.108
1N6071	165.0	180.0	- 220.0	1	308.0	5	4.9	.108
*1N6071A	170.0	190.0	- 210.0	1	294.0	5	5.1	.108
1N6072	175.0	198.0	- 242.0	1	344.0	5	4.3	.108
*1N6072A	185.0	209.0	- 231.0	1	328.0	5	4.6	.108

*Available in JAN, JANTX, JANTXV

NOTE 1: A TAZ is normally selected according to the rated "Stand Off Voltage" V_{RM} which should be equal to or greater than the DC or continuous peak operating voltage level.