



PACIFIC DISPLAY DEVICES

LCD Component Data Sheet

Model Number: 240128-06

**240 x 128 Dot
Graphic LCD Assembly
With T6963C Toshiba Graphic LCD Controller
EL Panel & LED Backlight Assembly**

CONTENTS

1.	GENERAL INFORMATION	
1.1	Product Overview	2
1.2	Part Options and Numbering System	2
1.3	Absolute Maximum Ratings	3
1.4	Circuit Block Diagram	3
1.5	Mechanical Characteristics	3
1.6	Input Signal Function	4
1.7	LCM Power, Contrast Control and Bias	4
1.8	LCD Dimensions	5
2.	ELECTRICAL / OPTICAL CHARACTERISTICS	
2.1	DC Electrical Characteristics	6
2.2	AC Electrical Characteristics	7
2.3	Optical Characteristics	9
2.4	LED Backlight Characteristics	11
2.5	EL Panel Backlight Characteristics	12
3.	LCD CONTROLLER CHARACTERISTICS	
3.1	LCD Controller Display and Control Functions (T6963)	13
3.2	LCD Controller Command List	26
3.3	LCD Controller Character Code map	27
3.4	Application Circuits	28
4.	RELIABILITY	29
5.	PRECAUTIONS FOR USING LCD MODULES	30

1. GENERAL INFORMATION

1.1 Product Overview

- 240 x 128 dot matrix LCD
- STN (Super Twisted Nematic) or FSTN (Film compensated Super Twisted Nematic) Technology
- T-6963 (or equivalent) Graphics Controller IC w/ 8K SRAM.
- Multiplex drive : 1/128 duty, 1/13 bias
- LCD Module Service Life: 100,000 hours minimum

1.2 Part Options and Numbering System

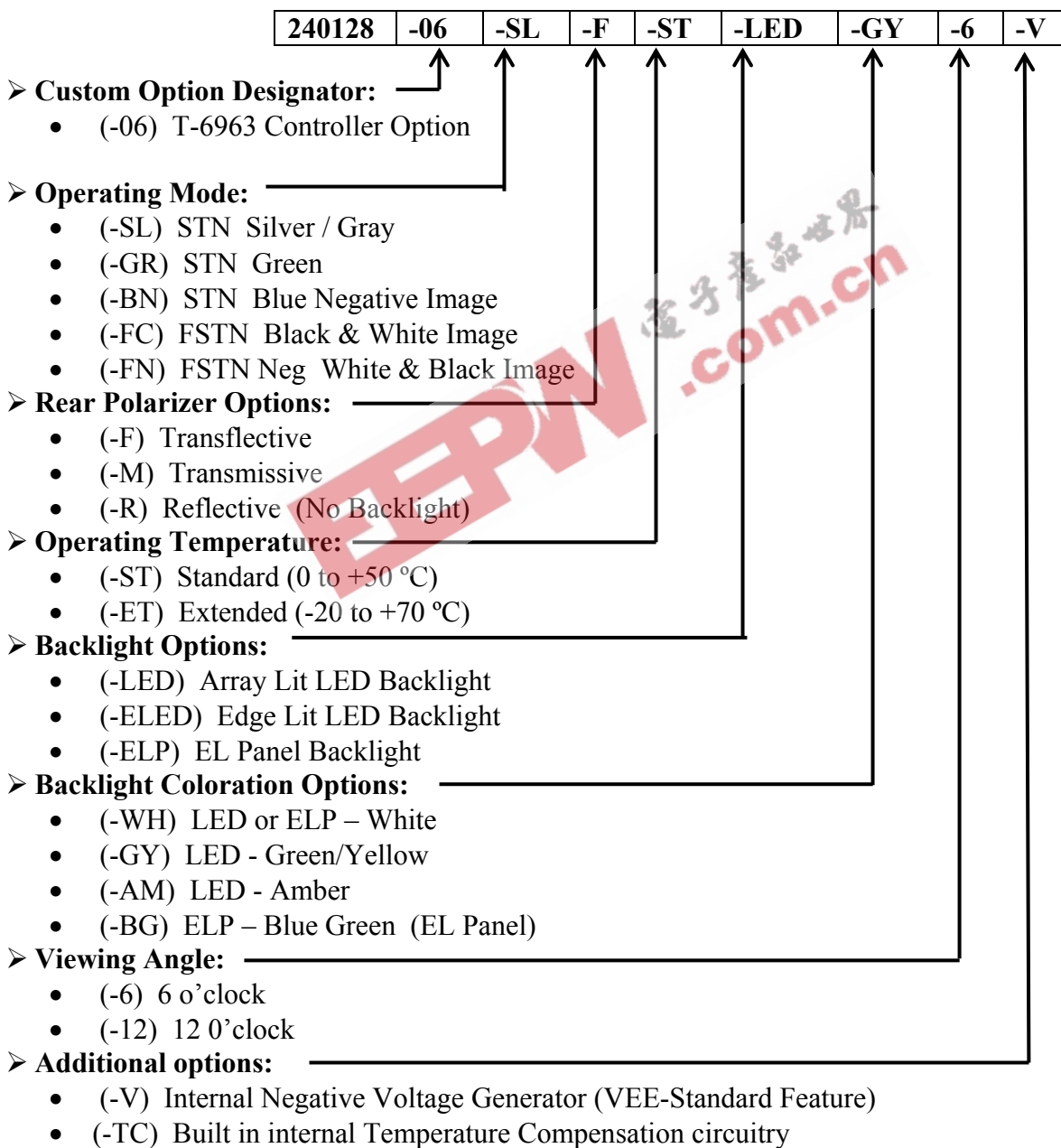

1.3 Absolute Maximum Ratings

Parameter	Symbol	Min	Max	Unit
Supply voltage for logic	V_{DD}	-0.3	7.0	V
Supply voltage for LCD	$V_{DD} - V_0$	-0.3	30.0	V
Input voltage	V_I	-0.3	$V_{DD} + 0.3$	V
Standard Operating temperature	TOP (-ST)	0	50	°C
Standard Storage temperature	TST (-ST)	-10	60	°C
Extended Operating temperature	TOP (-ET)	-20	70	°C
Extended Storage temperature	TST (-ET)	-30	80	°C
Soldering Temp	Tsolder	260		°C

1.4 Circuit Block Diagram

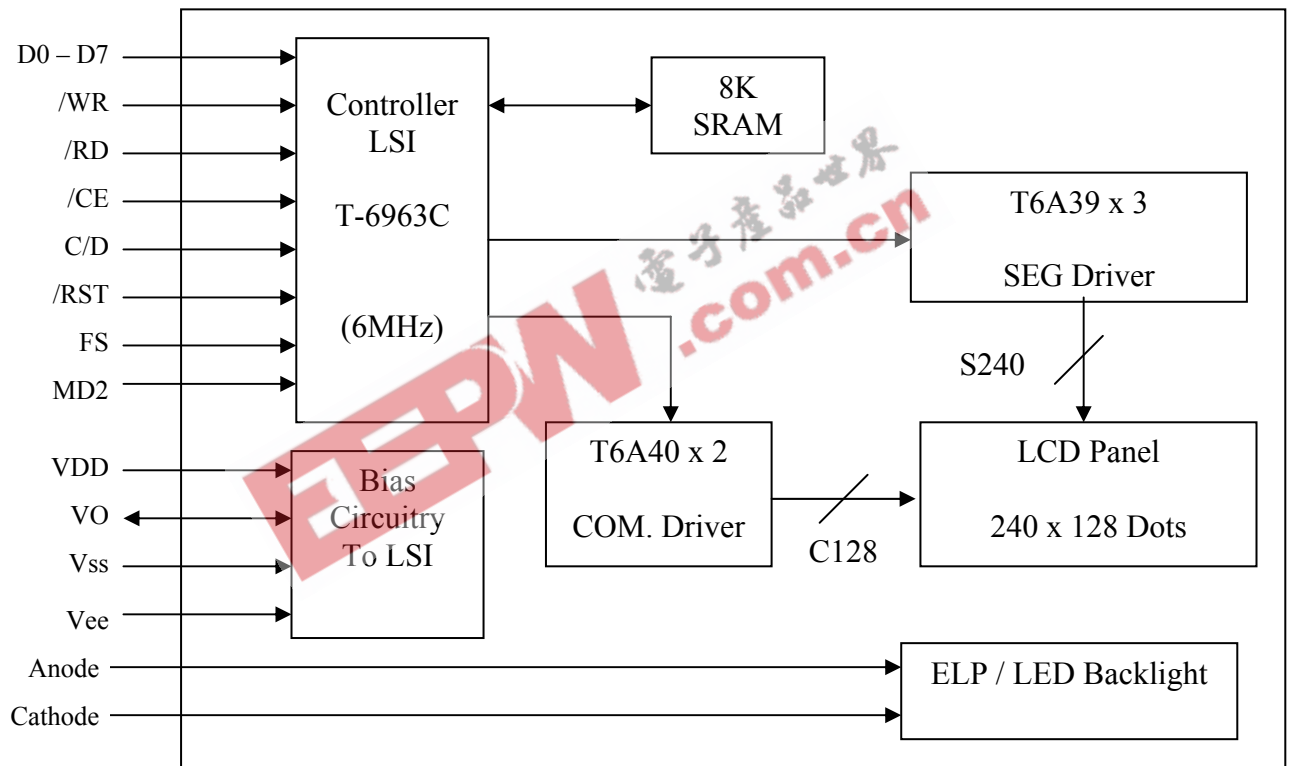

1.5 Mechanical Characteristics

Item	Contents	Unit
Module size (W×H×T)	144.0 x 104.0 x 14.1 Max (LED Backlight)	mm
	144.0 x 104.0 x 10.0 Max (Reflective / ELP Backlight)	mm
Viewing area (W×H)	114.0 x 64.0	mm
Active area (W×H)	107.95 x 57.55	mm
Number of dots	240 x 128	dots
Dot size (W×H)	0.40 x 0.40	mm
Dot pitch (W×H)	0.45 x 0.45	mm

1.6 Input Signal Function

Pin No.	Symbol	Level	Description
1	VSS	0V	Ground
2	VDD	5.0V	Supply voltage for logic
3	VO	Input	LCD Negative Bias
4	C/D	H/L	Code / Data
5	/RD	H/L	/Data Read
6	/WR	H/L	/Data Write
7-14	DB0-DB7	H/L	Bidirectional Data Bus Lines
15	/CE	H/L	/Chip Enable
16	/RST	L	/Reset
17	VEE	-20V	Output voltage for LCD (-V Option only, otherwise N.C.)
18	MD2	--	H=32, L=40
19	FS1	H/L	Font Select: H=6x8, L=8x8
20	NC	---	No Connection
A	LED A or BL2	---	LED Backlight Anode Connection or EL Backlight power
K	LED K or BL1	---	LED Backlight Cathode Connection or EL Backlight power

1.7 LCM Power, Contrast Control and Bias

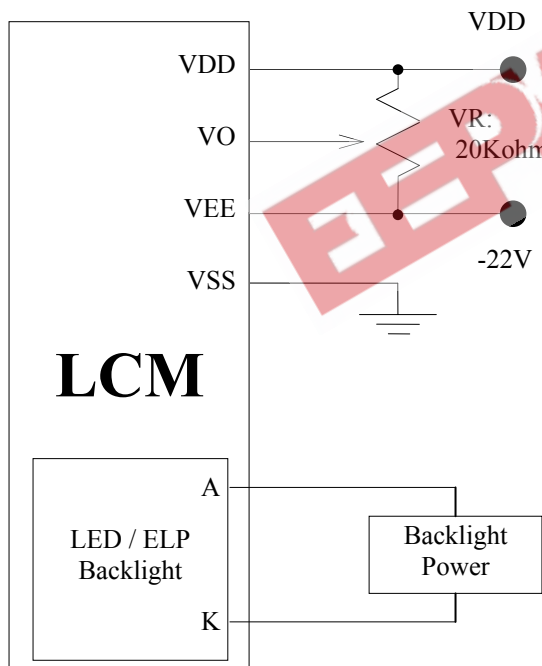

*Note : DC-to-DC Converter Not Built In

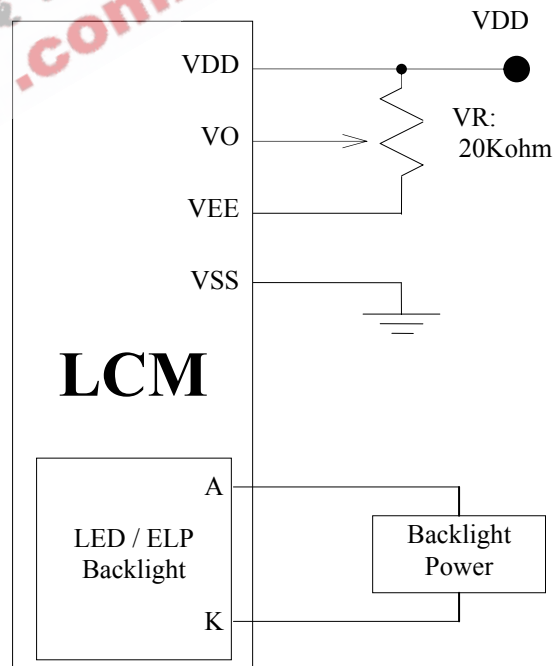

*Note : DC-to-DC Converter Built In (-V Option)

1.8 LCM Dimensions

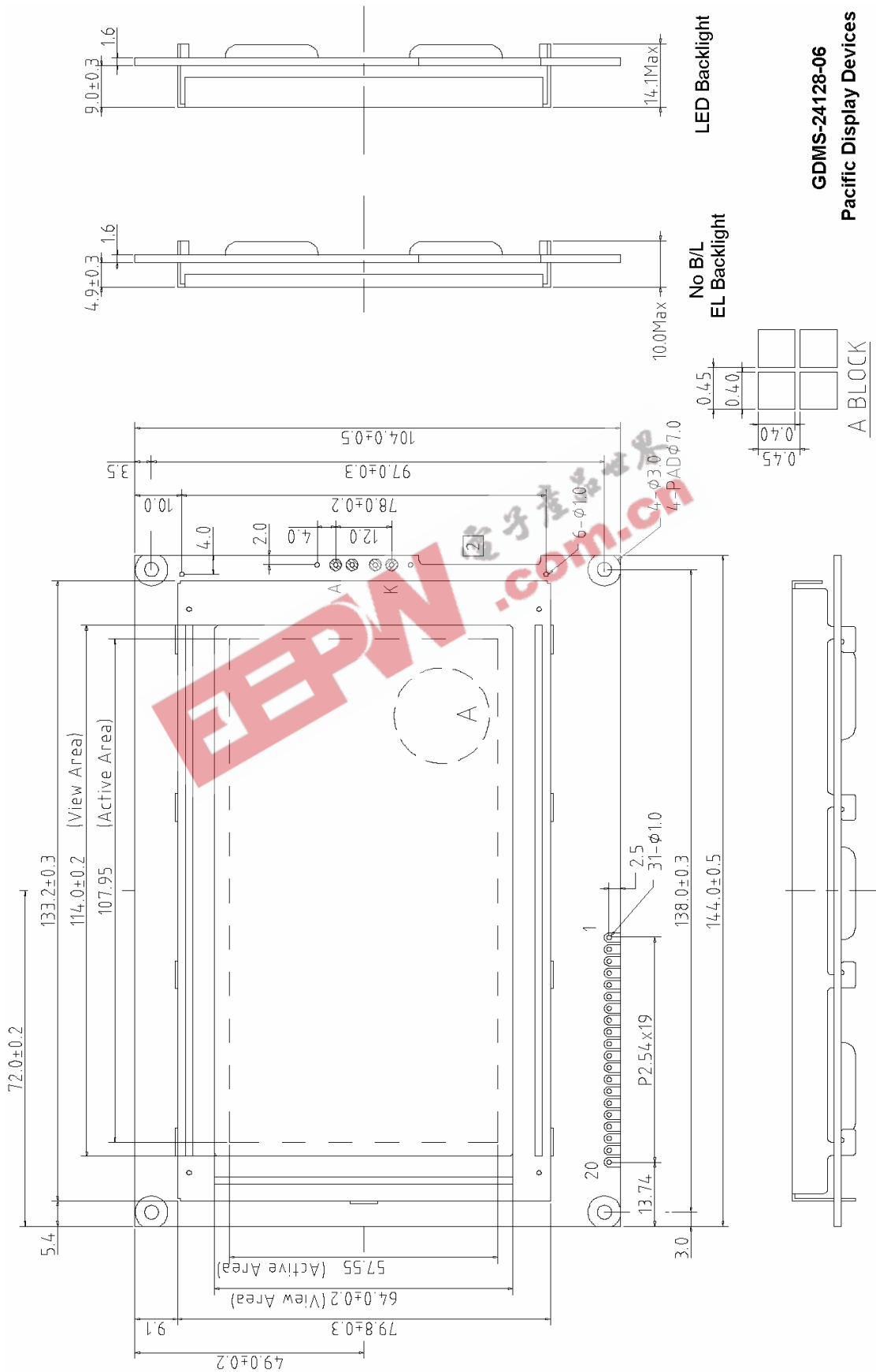

2. ELECTRICAL / OPTICAL CHARACTERISTICS

2.1 DC Electrical Characteristics ($V_{DD} = +5V \pm 10\%$, $V_{SS} = 0V$, $T_a = 25^\circ C$)

Parameter	Symbol	Condition	Min	Typ	Max	Unit
Supply voltage for logic	V_{DD}	---	4.5	---	5.5	V
Supply current for logic	I_{DD}	$V_{DD} = 5V$	---	12	15	mA
Input voltage 'H' level	V_{IH}	---	$V_{DD} - 2.2$	---	V_{DD}	V
Input voltage 'L' level	V_{IL}	---	0	---	0.8	V
Operating voltage for LCD	$V_{DD} - V_o$	-20°C	---	22.1	---	V
		25°C	---	19.3	---	V
		70°C	---	13.3	---	V
Supply current for LCD	I_o	---	---	---	5	mA

*Vee externally supplied

■ TIMING OF POWER SUPPLY

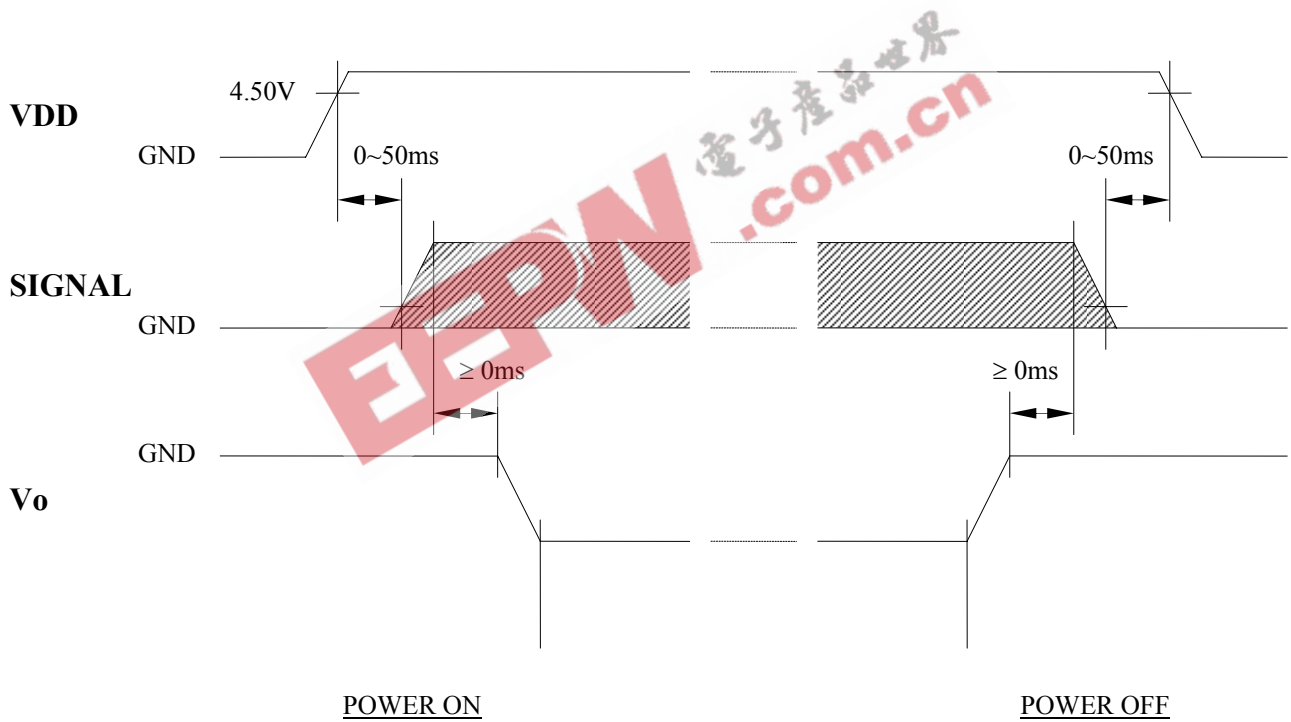

Note : The missing pixels may occur when the LCM is driven except above power supply timing sequence.

2.2 AC Electrical Characteristics

Toshiba T-6963C Graphic Controller IC AC Waveform Interface

■ AC Characteristics (1)

Parameter	Symbol	Min	Max	Unit
Operating Frequency	fSCP	---	2.75	MHz
SCP Pulse Width	tCWH, tCWL	150	---	ns
SCP Rise/Fall Time	t _r , t _f	---	30	ns
LP Set Up Time	tLSU	150	290	ns
LP Hold Time	tLHD	5	40	ns
Data Set Up Time	tDSU	170	---	ns
Data Hold Time	tDHD	80	---	ns
FR Delay Time	t _d	0	90	ns
CDATA Set Up Time	tCSU	450	850	ns
CDATA Hold Time	tCHD	450	950	ns

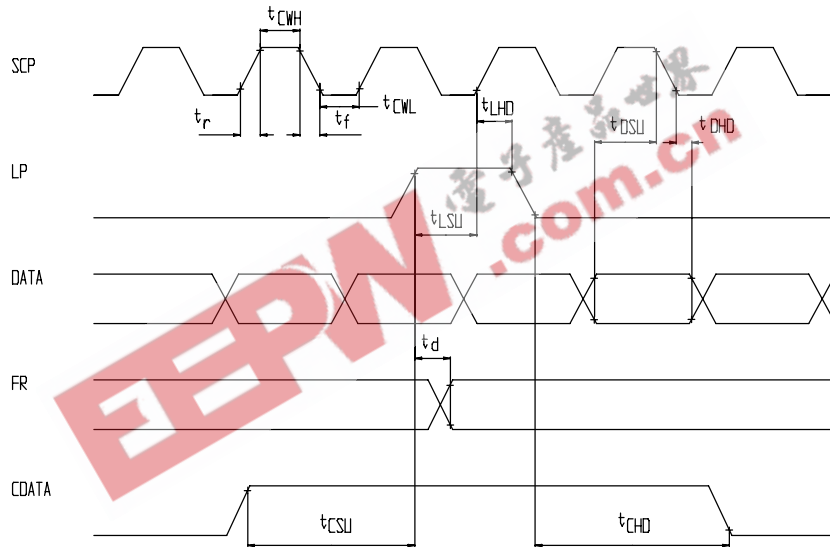

■ AC Characteristics (2)

Parameter	Symbol	Min	Max	Unit
C/D Set Up Time	tCDS	100	---	ns
C/D Hold Time	tCDH	10	---	ns
CE, RD, WR Pulse Width	tCE, tRD, tWR	80	---	ns
Data Set Up Time	tDS	80	---	ns
Data Hold Time	tDH	40	---	ns
Access Time	tACC	---	150	ns
Output Hold Time	tOH	10	50	ns

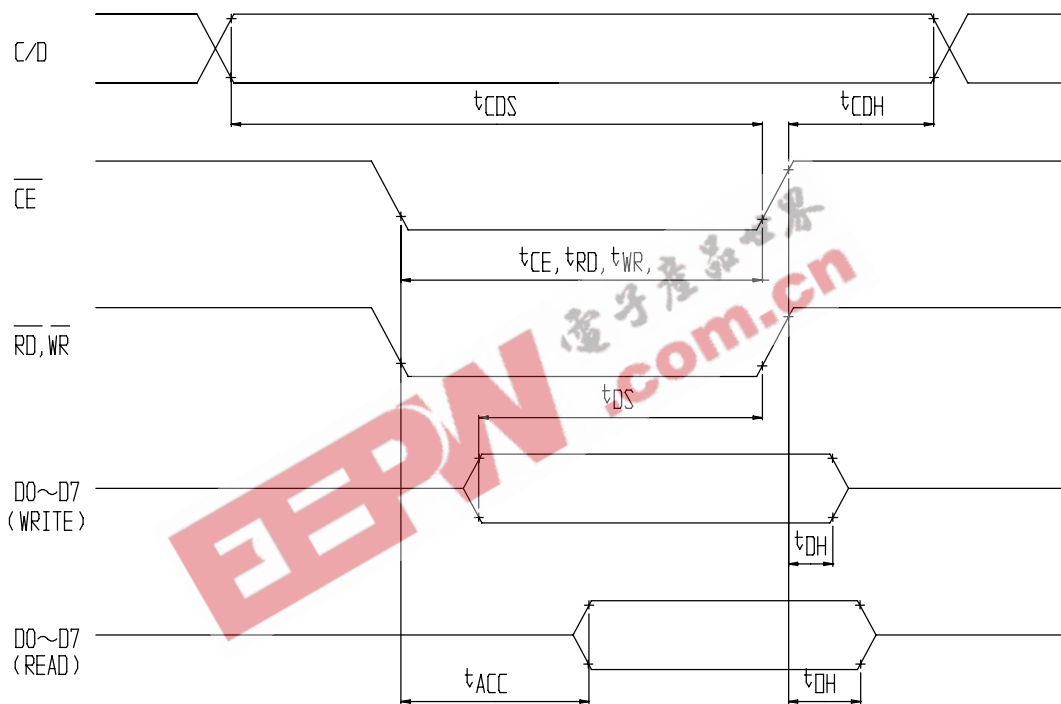

2.3 Optical Characteristics ($V_{OP} = 4.7V, T_a = 25^{\circ}C$)

Item	Symbol	Condition	Min	Typ	Max	Unit
Contrast ratio	Cr	$\theta=0^{\circ}$ $\phi=0^{\circ}$	---	2.6	---	---
Frame Frequency	f_{FRM}	---	32	64	150	Hz
Viewing angle range	θ_1	25°C	-35	---	35	deg
	θ_2		35	---	-35	deg
Response time	T_{on}	25°C	---	120	---	ms
	T_{off}		---	250	---	ms

Definition of angles ϕ and θ :

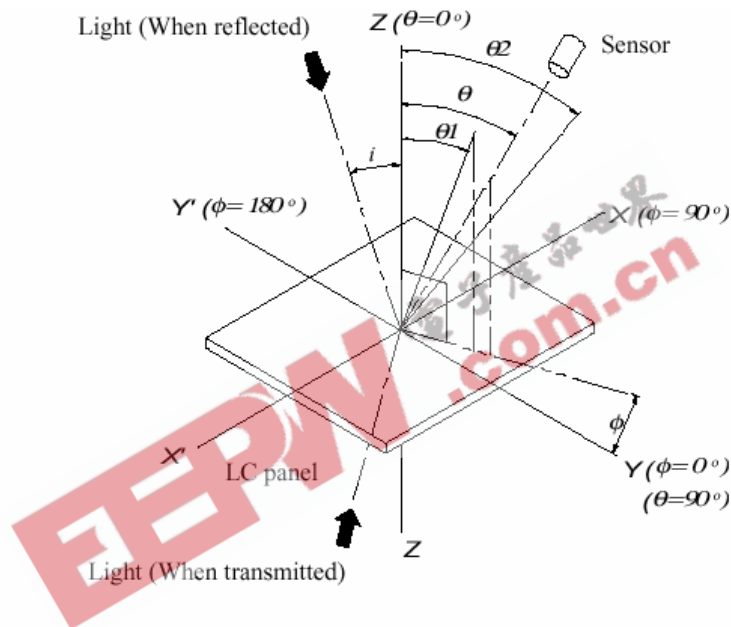

*Definition of contrast C

$$C = \frac{B1}{B2} = \frac{\text{Brightness of selected portion}}{\text{Brightness of unselected portion}}$$

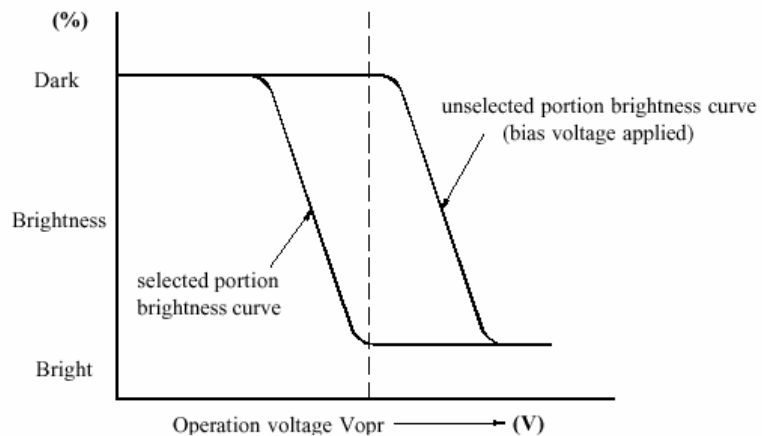

*Definition of viewing angles θ_1 and θ_2

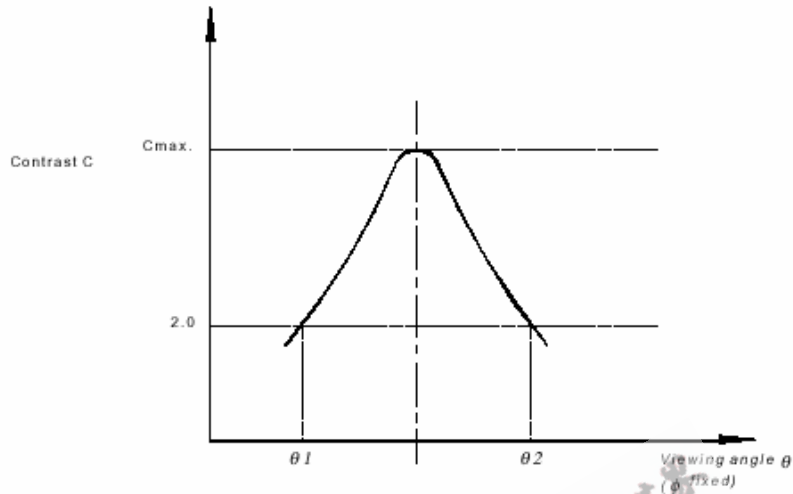

Note : Optimum vision with the naked eye and viewing angle θ at C_{max} above are not always the same.

*Definition of response time

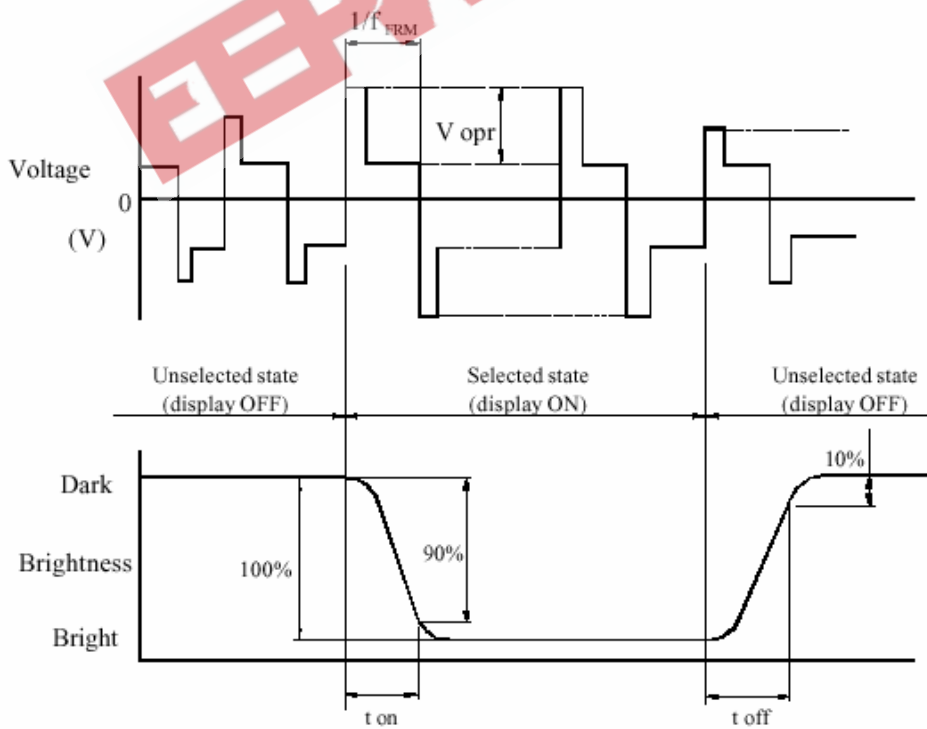

V_{opr} : Operating voltage (V)

t_{on} : Response time (rise) (ms)

f_{FRM} : Frame frequency (Hz)

t_{off} : Response time (fall) (ms)

2.4 LED Backlight Characteristics

■ Yellow-Green LED Operating Characteristics (5V - Array Lit)

Item	Symbol	Conditions	Standard			Unit
			Min.	Typ.	Max.	
Forward Voltage	V_f	Ta= 25 °C	3.9	4.1	4.4	VDC
Forward Current	I_F	Ta= 25 °C	---	1100	1700	mA
Reverse Current	I_R	VR = 8V Yel/Grn	---	---	11	mA
Peak Emission Wavelength	λ_P	If=1100mA Yel/Grn	---	570	---	nm

Item	Conditions	Standard		Unit
		Min.	Max.	
Life	Ta= 25 °C	100,000	---	hrs

■ Yellow-Green LED Operating Characteristics (12V - Array Lit)

Item	Symbol	Conditions	Standard			Unit
			Min.	Typ.	Max.	
Forward Voltage	V_f	Ta= 25 °C	10.0	10.5	11.0	VDC
Forward Current	I_R	Ta= 25 °C	---	440	700	mA
Reverse Current	I_R	VR = 8V Yel/Grn	---	---	6	mA
Peak Emission Wavelength	λ_P	If=440mA Yel/Grn	---	570	---	nm

Item	Conditions	Standard		Unit
		Min.	Max.	
Life	Ta= 25 °C	100,000	---	hrs

■ Yellow-Green LED Operating Characteristics (Edge Lit)

Item	Symbol	Conditions	Standard			Unit
			Min.	Typ.	Max.	
Forward Voltage	V_f	Ta= 25 °C	3.9	4.1	4.4	VDC
Forward Current	I_F	Ta= 25 °C	---	260	440	mA
Reverse Current	I_R	VR = 8V Yel/Grn	---	---	11	mA

Item	Conditions	Standard		Unit
		Min.	Max.	
Life	Ta= 25 °C	100,000	---	hrs

■ White LED Operating Characteristics (Edge Lit)

Item	Symbol	Conditions	Standard			Unit
			Min.	Typ.	Max.	
Forward Voltage	V_f	Ta= 25 °C	---	3.5	3.8	VDC
Forward Current	I_R	Ta= 25 °C	---	160	350	mA
Reverse Current	I_R	VR = 5V Wht	---	---	0.8	mA
Peak Emission Wavelength	λ_P	If=160mA Wht	---	---	---	nm

Item	Conditions	Standard		Unit
		Min.	Max.	
Life	Ta= 25 °C	20,000	---	hrs

■ Standard Yellow-Green LED Backlight Notes:

- (1) There are two versions of the LED backlight for this module, 12V and 5V. Both have 220 yellow-green LEDs. The 12V version has them arranged in 44 branches of 5 diodes and the 5V version has 110 branches of 2 diodes
- (2) The 5V “array” version operates at 4.1V. Its typical current draw is 1.1A. Current should be limited to 1.7A max.
- (3) The 12V “array” version actually operates at 10.5V. Typical current draw for this version is 440mA @ 10.5V. Current should be limited to 700mA max.
- (4) The 12V option can be ordered with a “-12V” at the end of the part number

2.5 EL Panel Backlight Characteristics (Blue-Green)

■ Blue-Green EL Panel Operating Characteristics:

Item	Conditions	Standard			Unit
		Min.	Typ.	Max.	
Current Consumption	100VAC RMS, 400Hz Ta: 25°C	---	10	20	mA
EL Drive Voltage	---	---	100	150	VAC RMS
EL Drive Frequency	---	---	400	1000	Hz
Operating Temperature	---	-35°C	---	+50°C	°C
Storage Temperature	---	-40°C	---	+60°C	°C
Luminance	100VAC RMS, 400Hz	40	50	---	cd/m ²
Luminance Half-Life	Ta: 25°C	3500	---	---	Hrs

*Note: half life is defined as Luminance being reduced by 50%

3. OPERATING PRINCIPALS AND METHODS

3.1 LCD Controller Display and Control Functions (T-6963C Controller)

■ Flowchart of Communications with MPU

● Status Read

Before sending data (Read/Write) command, it is necessary to check the status.

Status check

Status of T6963C can be read from data lines.

RD	L
WR	H
CE	L
C/D	H
D0-D7	Status word

T6963C status word format is following.

MSB						LSB	
STA7	STA6	STA5	STA4	STA3	STA2	STA1	STA0
D7	D6	D5	D4	D3	D2	D1	D0

STA0	Check capability of command execution	0 : Disable 1 : Enable
STA1	Check capability of data read/write	0 : Disable 1 : Enable
STA2	Check capability of auto mode data read	0 : Disable 1 : Enable
STA3	Check capability of auto mode data write	0 : Disable 1 : Enable
STA4	Not use	
STA5	Check capability of controller operation	0 : Disable 1 : Enable
STA6	Error flag. Using screen peek/copy command	0 : No error 1 : Error
STA7	Check the condition blink	0 : Display off 1 : Normal display

Note 1 : It is necessary to check STA0 and STA1 at the same time. The error is happened by sending data at executing command.

Note 2 : The status check will be enough to check STA0/STA1.

Note 3 : STA2/STA3 are valid in auto mode STA0/STA1 are invalid.

Status checking flow

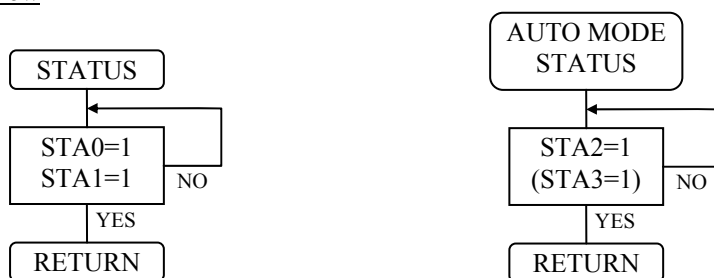

Note 4 : It is impossible to save status check in the case of command of MSB0. To have the delay time cannot be save status check. The interrupt of hardware is happened at the end of lines. If command of MSB0 is sent in this period, the command executing is waited. The state of waiting doesn't be known without to check status. The sending next command or data is disregarded or rewrites data of waiting command.

- In T6963C, the data have been set and command executes.

The order of procedure of command sending

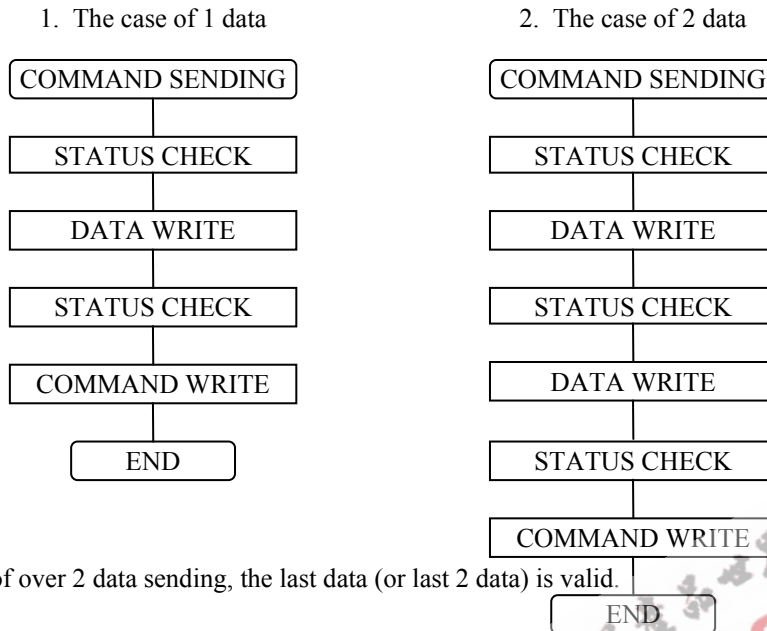

Note : In case of over 2 data sending, the last data (or last 2 data) is valid.

■ **Description of Command**

- Register Set

Code	Hex	Function	D1	D2
00100001	21H	Cursor Pointer Set	X ADRS	Y ADRS
00100010	22H	Offset Register Set	Data	00H
00100100	24H	Address Pointer Set	Low ADRS	High ADRS

(1) Cursor Pointer Set

The position of cursor is specified by X ADRS, Y ADRS. The cursor position is moved only by this command. The cursor pointer doesn't have the function of increment and decrement. The shift of cursor are set by this command. X ADRS, Y ADRS are specified following.

X ADRS 00H~4FH (Lower 7bits are valid)
 Y ADRS 00H~1FH (Lower 5bits are valid)

1 screen drive	2 screens drive
X ADRS 00~4FH	X ADRS 00~4FH
Y ADRS 00H~0FH	Y ADRS 00H~0FH Upper screen
	Y ADRS 10H~1FH Lower screen

(2) Offset Register Set

The offset register is used to determine external character generator RAM area.

T6963C has 16 bit address lines as follow.

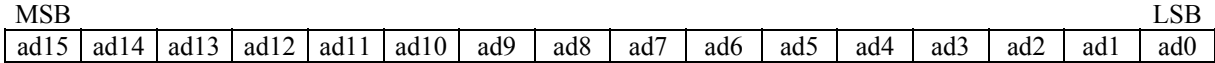

The upper 5 bit (ad15~ad11) are determined by offset register. The middle 8 bit (ad10~ad3) are determined by character code. The lower 3 bit (ad2~ad0) are determined by vertical counter. The lower 5 bit of D1 (data) are valid. The data format of external character generator RAM.

The relationship of display RAM address and offset register

Data of offset register	CG RAM HEX address(start-end)
00000	0000-07FFH
00001	0800-0FFFH
00010	1000-17FFH
11100	E000-E7FFH
11101	E800-EFFFH
11110	F000-F7FFH
11111	F800-FFFFH

(Example 1)

Offset register	02H				
Character code	80H				
Character generator RAM start address	0001	0100	0000	0000	
	1	4	0	0	H

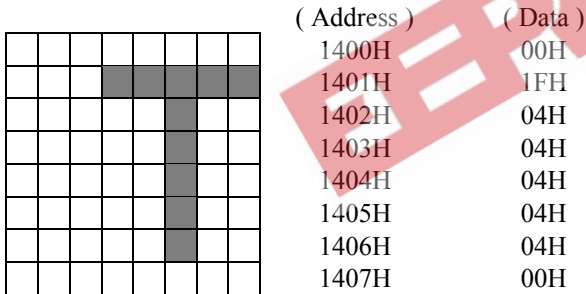

(Example 2)

The relationship of display RAM data and display character

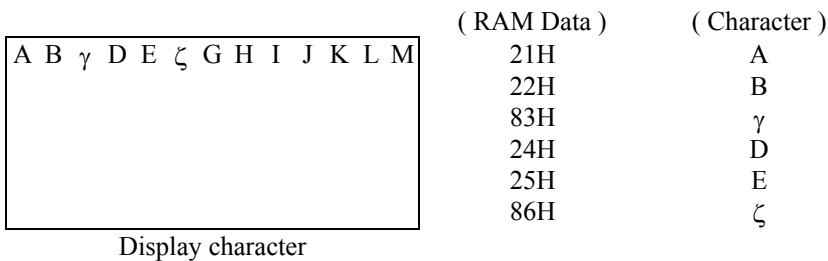

Note : γ and ζ are displayed by character generator RAM.

(3) Address Pointer Set

The address pointer set command is used to indicate the start address for writing (or reading) to external RAM.

The flow chart address pointer set command

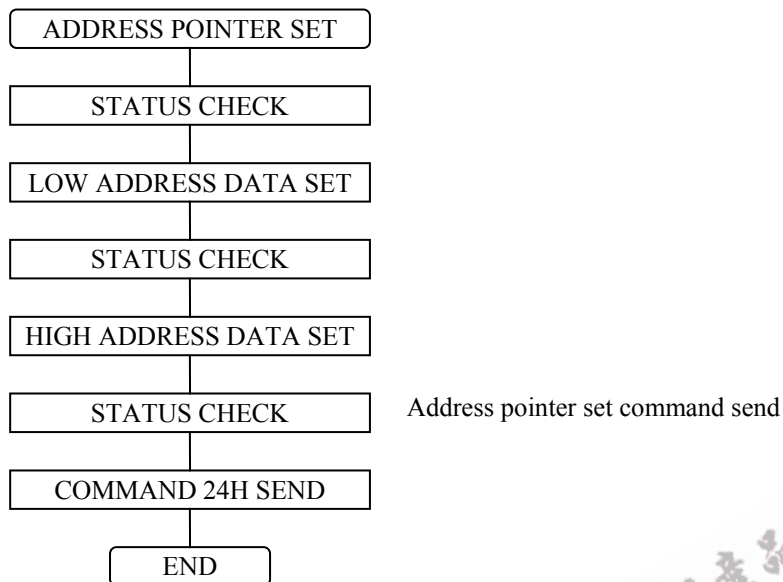

• Control Word Set

Code	Hex	Function	D1	D2
01000000	40H	Text home address set	Low address	High address
01000001	41H	Text area set	Columns	00H
01000010	42H	Graphic home address set	Low address	High address
01000011	43H	Graphic area set	Columns	00H

The home address and column size are defined by this command.

(1) Text Home Address Set

The starting address of external display RAM for Text display is defined by this command. The text home address shows the left end and most upper position.

The relationship of external display RAM address and display position

TH		TH+CL
TH+TA		TH+TA+CL
(TH+TA)+TA		TH+2TA+CL
(TH+2TA)+TA		TH+3TA+CL
TH+(n-1)TA		TH+(n-1)TA+CL

TH : Text home address

TA : Text area number (columns)

CL : Columns are fixed by hardware. (pin-programmable)

(Example)

Text home address : 0000H
 Text area : 0020H
 MD2=H, MD3=H : 32 columns
 DUAL=H, MDS=L, MD0=L, MD1=L : 16 lines

0000H	0001H	001EH	001FH
0020H	0021H	003EH	003FH
0040H	0041H	005EH	005FH
0060H	0061H	007EH	007FH
0080H	0081H	009EH	009FH
00A0H	00A1H	00BEH	00BFH
00C0H	00C1H	00DEH	00DFH
00E0H	00E1H	00FEH	00FFH
0100H	0101H	011EH	011FH
0120H	0121H	013EH	013FH
0140H	0141H	015EH	015FH
0160H	0161H	017EH	017FH
0180H	0181H	019EH	019FH
01A0H	01A1H	01BEH	01BFH
01C0H	01C1H	01DEH	01DFH
01E0H	01E1H	01FEH	01FFH

(2) Graphic Home Address Set

The starting address of external display RAM for Graphic display is defined by this command. The graphic home address shows the left end most upper line.

The relationship of external display RAM address and display position

GH		GH+CL
GH+GA		GH+GA+CL
(GH+GA)+GA		GH+2GA+CL
(GH+2GA)+GA		GH+3GA+CL
GH+(n-1)GA		GH+(n-1)GA+CL

GH : Graphic home address

GA : Graphic area number (columns)

CL : Columns are fixed by hardware. (pin-programmable)

(Example)

Graphic home address : 0000H
 Graphic area : 0020H
 MD2=H, MD3=H : 32 columns
 DUAL=H, MDS=L, MD0=L, MD1=L : 16 lines

0000H	0001H	001EH	001FH
0020H	0021H	003EH	003FH
0040H	0041H	005EH	005FH
0060H	0061H	007EH	007FH
.....
0F80H	0F81H	0F9EH	0F9FH
0FA0H	0FA1H	0FBEH	0FBFH
0FC0H	0FC1H	0FDEH	0FDFH
0FE0H	0FE1H	0FFEH	0FFFH

(3) Text Area Set

The columns of display are defined by the hardware setting. This command can be used to adjust columns of display.

(Example)

Text home address : 0000H
 Text area : 001EH
 MD2=H, MD3=H : 32 columns
 DUAL=H, MDS=L, MD0=L, MD1=L : 16 lines

0000H	0001H	001DH	001EH	001FH
001EH	001FH	003BH	003CH	003DH
003CH	003DH	0059H	005AH	005BH
005AH	005BH	0077H	0078H	0079H
0078H	0079H	0095H	0096H	0097H
0096H	0097H	00B3H	00B4H	00B5H
00B4H	00B5H	00D1H	00D2H	00D3H
00D2H	00D3H	00EFH	00F0H	00F1H
00F0H	00F1H	010DH	010EH	010FH
010EH	010FH	012BH	012CH	012DH
012CH	012DH	0149H	014AH	014BH
014AH	014BH	0167H	0168H	0169H
0168H	0169H	0185H	0186H	0187H
0186H	0187H	01A3H	01A4H	01A5H
01A4H	01A5H	01C1H	01C2H	01C3H
01C2H	01C3H	01DFH	01E0H	01E1H



(4) Graphic Area Set

The columns of display are defined by the hardware setting. This command can be used to adjust columns of graphic display.

(Example)

Text home address : 0000H
 Text area : 001EH
 MD2=H, MD3=H : 32 columns
 DUAL=H, MDS=L, MD0=L, MD1=L : 16 lines

0000H	0001H	001DH	001EH	001FH
001EH	001FH	003BH	003CH	003DH
003CH	003DH	0059H	005AH	005BH
005AH	005BH	0077H	0078H	0079H
.....
0E88H	0E89H	0EA5H	0EA6H	0EA7H
0EA6H	0FA7H	0EC3H	0EC4H	0EC5H
0EC4H	0FC5H	0EE1H	0EE2H	0EE3H
0EE2H	0FE3H	0EFFH	0F00H	0F01H



The address in graphic area can be continuous and RAM area can be used without ineffective area, if graphic area is defined the same number as the actual column number of LCD display.

• Mode Set

Code	Function	Operand
1000x000	"OR" Mode	---
1000x001	"EXOR" Mode	---
1000x011	"AND" Mode	---
1000x100	"TEXT ATTRIBUTE" Mode	---
10000xxx	Internal Character Generator Mode	---
10001xxx	External Character Generator Mode	---

x : Don't care

The display mode is defined by this command. The display mode don't have changed until to send next this command. Logically "OR", "EXOR", "AND" of text and graphic display can be displayed.

When internal character generator mode is selected, character code 00H~7FH are selected from built-in character generator ROM. The character code 80H~FFH are automatically selected external character generator RAM.

(Example)

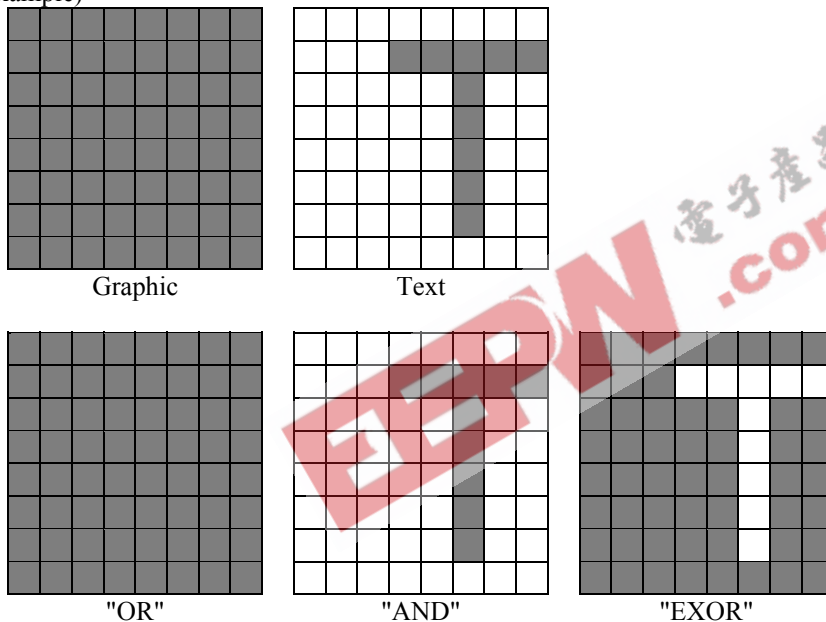

Note : Only text display is attributed, because attribute data is located in graphic RAM area.

Attribute function

"Reverse display", "Character blink" and "Inhibit" are called "Attribute". The attribute data is written in the graphic area defined by control word set command. The mode set command selects text display only and graphic display cannot be displayed.

The attribute data of the 1st character in text area is written at the 1st byte in graphic area, and attribute data of n-th character is written at the n-th byte in graphic area. Attribute function is defined as follow.

Attribute RAM byte	x	x	x	x	d3	d2	d1	d0
--------------------	---	---	---	---	----	----	----	----

d3	d2	d1	d0	Function
0	0	0	0	Normal display
0	1	0	1	Reverse display
0	0	1	1	Inhibit display
1	0	0	0	Blink of normal display
1	1	0	1	Blink of reverse display
1	0	1	1	Blink of inhibit display

• Display Mode

Code	Function	Operand
10010000	Display off	---
1001xx10	Cursor on, blink off	---
1001xx11	Cursor on, blink on	---
100101xx	Text on, graphic off	---
100110xx	Text off, graphic on	---
100111xx	Text on, graphic on	---

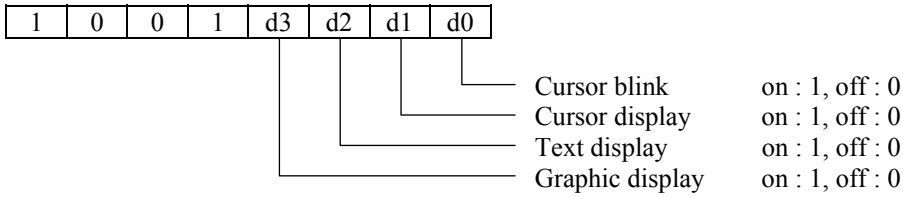

Note : It is necessary to turn on "Text display" and "Graphic display" in following case.

- 1) Combination of text/graphic display
- 2) Attribute function

• Cursor Pattern Select

Code	Function	Operand
10100000	1 line cursor	---
10100001	2 lines cursor	---
10100010	3 lines cursor	---
10100011	4 lines cursor	---
10100100	5 lines cursor	---
10100101	6 lines cursor	---
10100110	7 lines cursor	---
10100111	8 lines cursor	---

When cursor display is ON, this command selects the cursor pattern from 1 line to 8 lines. The cursor address is defined by cursor pointer set command.

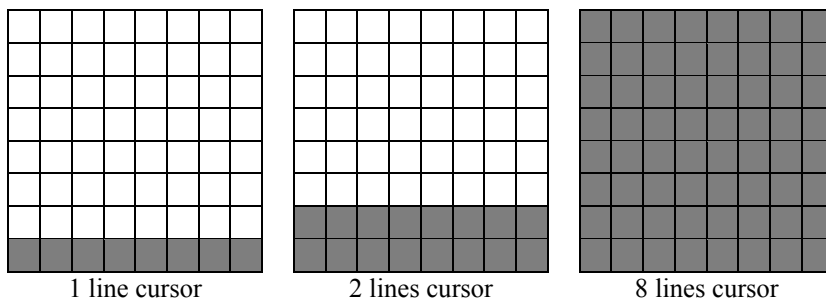

• Data Auto Read/Write

Code	Hex	Function	Operand
10110000	B0H	Data auto write set	---
10110001	B1H	Data auto read set	---
10110010	B2H	Auto reset	---

This command is convenient to send full screen data from external display RAM. After setting auto mode, "Data write (or read)" command is not necessary between each data. "Data auto write (or read)" command should follow the "Address pointer set" and address pointer is automatically increment by + 1 after each data. After sending (or receiving) all data "Auto reset" is necessary to return normal operation because all data is regarded "Display data" and no command can be accepted in the auto mode.

Note : Status check for auto mode (STA2,STA3) should be checked between each data. Auto reset should be performed after checking STA3=1 (STA2=1). Please refer following flow chart.

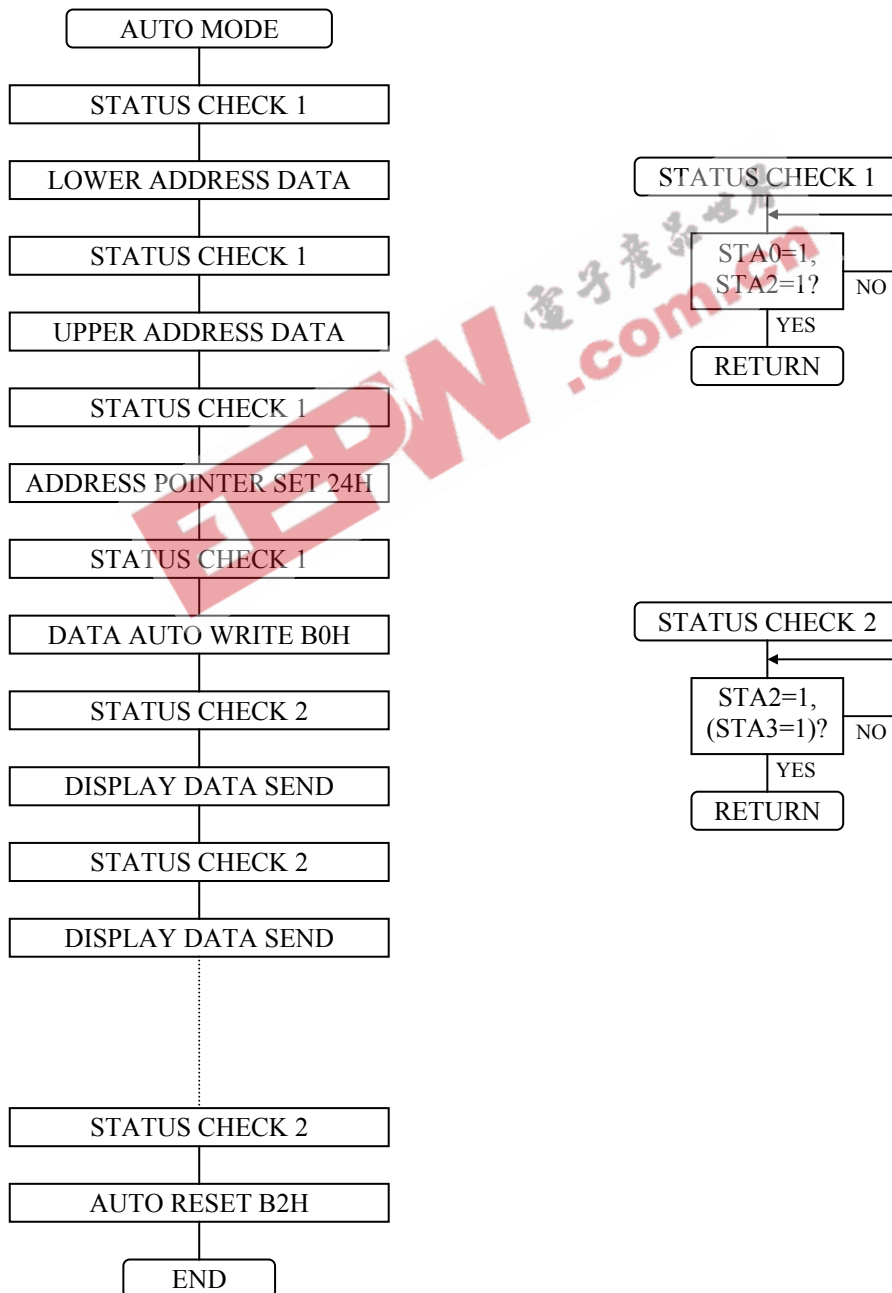

• Data Read Write

Code	Hex	Function	Operand
11000000	C0H	Data write and ADP increment	Data
11000001	C1H	Data read and ADP increment	---
11000010	C2H	Data write and ADP decrement	Data
11000011	C3H	Data read and ADP decrement	---
11000100	C4H	Data write and ADP non-variable	Data
11000101	C5H	Data read and ADP non-variable	---

This command is used for data write from MPU to external display RAM, and data read from external display RAM to MPU. Data write/data read should be executed after setting address by address pointer set command. Address pointer can be automatically increment or decrement by setting this command.

Note : This command is necessary for each 1 byte data. Please refer following flow chart.

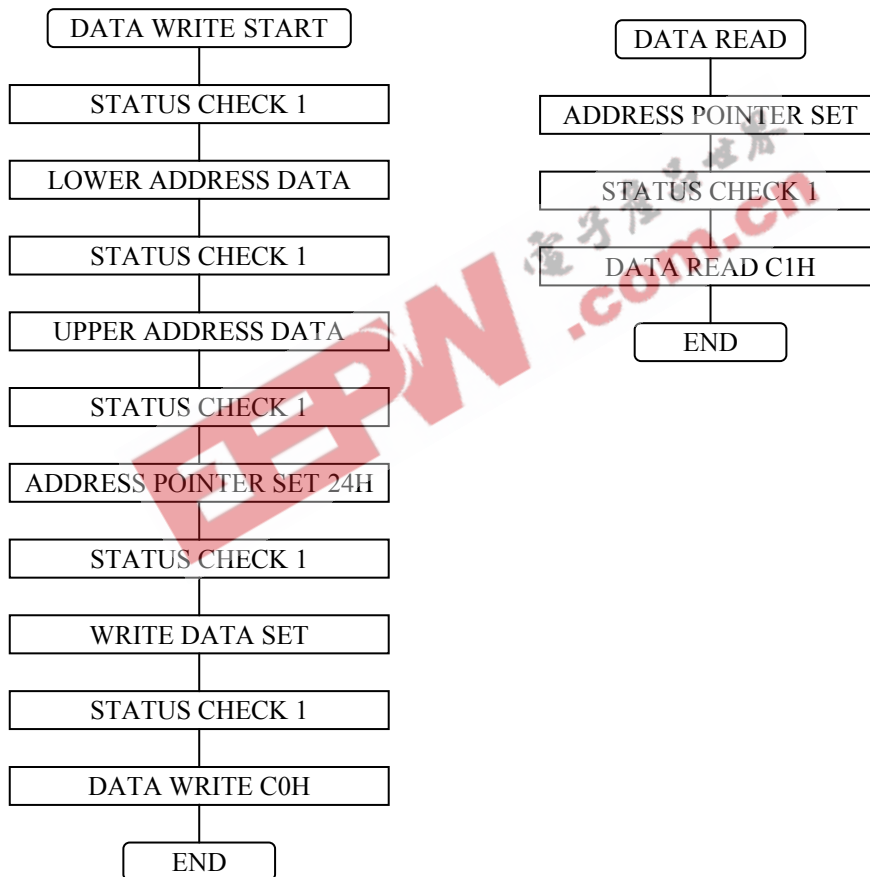

● Screen Peek

Code	Hex	Function	Operand
11100000	E0H	Screen Peek	---

This command is used to transfer displayed 1 byte data to data stack, and this 1 byte data can be read from MPU by data access. The logical combination data of text and graphic display on LCD screen can be read by this command.

The status (STA6) should be checked just after "Screen peek" command. If the address determined by "Address pointer Set" command is not in graphic area, this command ignored and status flag (STA6) is set. Please refer following flow chart.

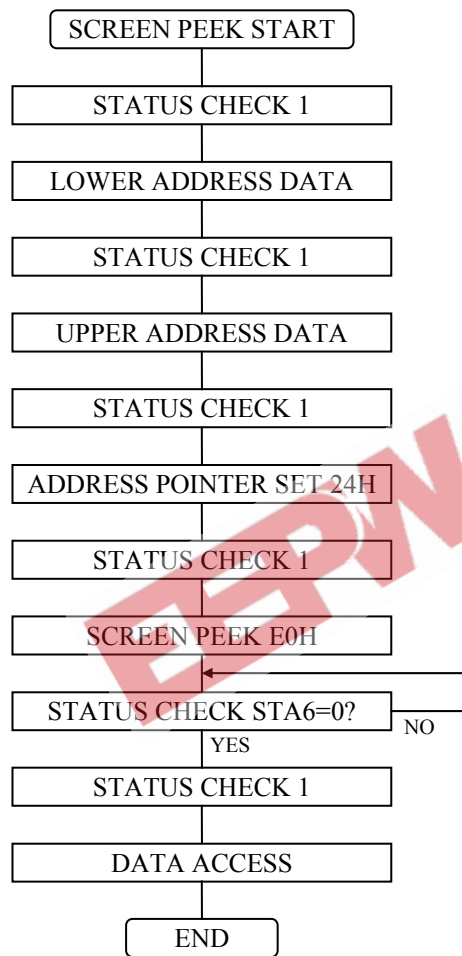

• Screen Copy

Code	Hex	Function	Operand
11101000	E8H	Screen copy	---

This command is used to copy displayed 1 line data to graphic area. The start point of 1 line data in the screen is determined by the address pointer. Please refer following flow chart.

Note 1 : In attribute function, this command is invalid. (Because attribute data is in the graphic area.)

Note 2 : In case of 2 screen drive, this command is invalid. (Because T6963C cannot separate upper screen data and lower screen data.)

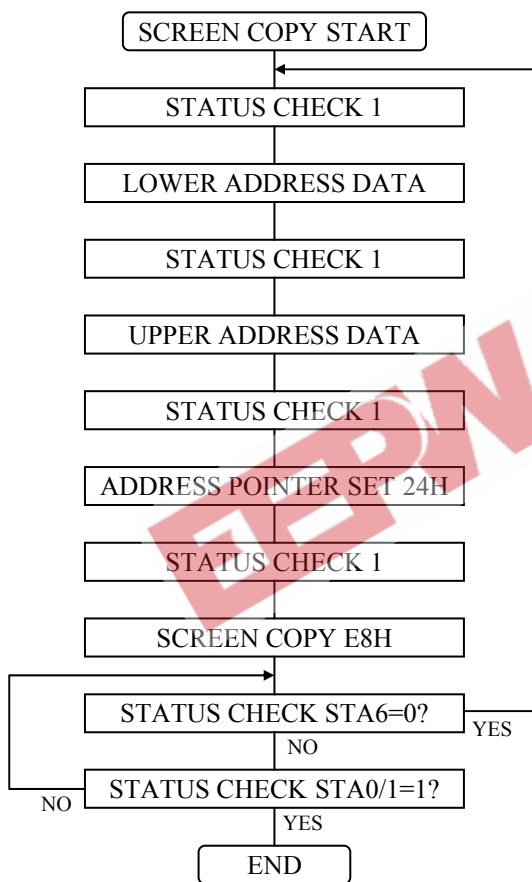

电子產品世界
www.eepw.com.cn

● Bit Set/Reset

Code	Function	Operand
11110xxx	bit reset	---
11111xxx	bit set	---
1111x000	bit 0 (LSB)	---
1111x001	bit 1	---
1111x010	bit 2	---
1111x011	bit 3	---
1111x100	bit 4	---
1111x101	bit 5	---
1111x110	bit 6	---
1111x111	bit 7 (MSB)	---

This command is used to set or reset a bit of 1 byte is specified by address pointer. Plural bits in the 1 byte data cannot be set/reset at a time. Please refer following flow chart.

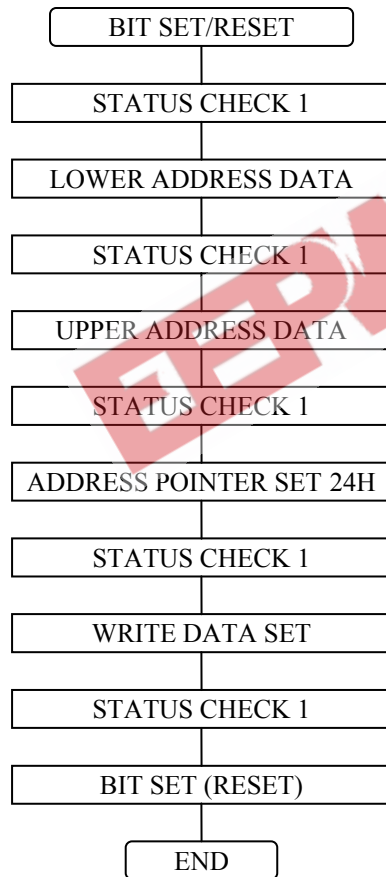

3.2 LCD Controller Command List

Command	Code	D1	D2	Function
Register Set	00100001	X address	Y address	Cursor pointer set
	00100010	Data	00H	Offset register set
	00100100	Low address	High address	Address pointer set
Control Word Set	01000000	Low address	High address	Text home address set
	01000001	Columns	00H	Text area set
	01000010	Low address	High address	Graphic home address set
	01000011	Columns	00H	Graphic area set
Mode Set	1000x000	---	---	"OR" mode
	1000x001	---	---	"EXOR" mode
	1000x011	---	---	"AND" mode
	1000x100	---	---	"Text attribute" mode
	10000xxx	---	---	Internal CG ROM mode
	10001xxx	---	---	External CG RAM mode
Display Mode	10010000	---	---	Display off
	1001xx10	---	---	Cursor on, blink off
	1001xx11	---	---	Cursor on, blink on
	100101xx	---	---	Text on, graphic off
	100110xx	---	---	Text off, graphic on
	100111xx	---	---	Text on, graphic on
Cursor Pattern Select	10100000	---	---	1 line cursor
	10100001	---	---	2 lines cursor
	10100010	---	---	3 lines cursor
	10100011	---	---	4 lines cursor
	10100100	---	---	5 lines cursor
	10100101	---	---	6 lines cursor
	10100110	---	---	7 lines cursor
	10100111	---	---	8 lines cursor
Data Auto Read/Write	10110000	---	---	Data auto write set
	10110001	---	---	Data auto read set
	10110010	---	---	Auto reset
Data Read Write	11000000	Data	---	Data write and ADP increment
	11000001	---	---	Data read and ADP increment
	11000010	Data	---	Data write and ADP decrement
	11000011	---	---	Data read and ADP decrement
	11000100	Data	---	Data write and ADP nonvariable
	11000101	---	---	Data read and ADP nonvariable
Screen Peek	11100000	---	---	Screen peek
Screen Copy	11101000	---	---	Screen copy
Bit Set/Reset	11110xxx	---	---	bit reset
	11111xxx	---	---	bit set
	1111x000	---	---	bit 0 (LSB)
	1111x001	---	---	bit 1
	1111x010	---	---	bit 2
	1111x011	---	---	bit 3
	1111x100	---	---	bit 4
	1111x101	---	---	bit 5
	1111x110	---	---	bit 6
	1111x111	---	---	bit 7 (MSB)

3.3 LCD Controller Character Code Map

ROM CODE 0101

MSB \ LSB	0	1	2	3	4	5	6	7	8	9	A	B	C	D	E	F
0		!	"	#	\$	%	&	'	()	*	+	,	-	.	/
1	0	1	2	3	4	5	6	7	8	9	:	;	<	=	>	?
2	A	B	C	D	E	F	G	H	I	J	K	L	M	N	O	
3	P	Q	R	S	T	U	V	W	X	Y	Z	[\]	^	_
4	'	a	b	c	d	e	f	g	h	i	j	k	l	m	n	o
5	p	q	r	s	t	u	v	w	x	y	z	{		}	~	
6	0	1	2	3	4	5	6	7	8	9	:	;	<	=	>	?
7	A	B	C	D	E	F	G	H	I	J	K	L	M	N	O	



3.4 Application Circuits

APPLICATION CIRCUIT (1)

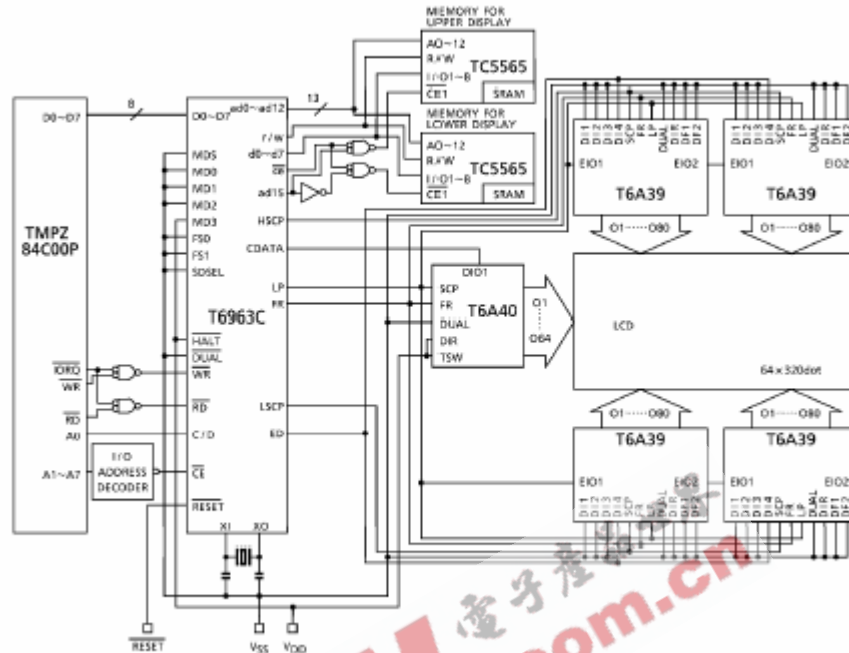

APPLICATION CIRCUIT (2)

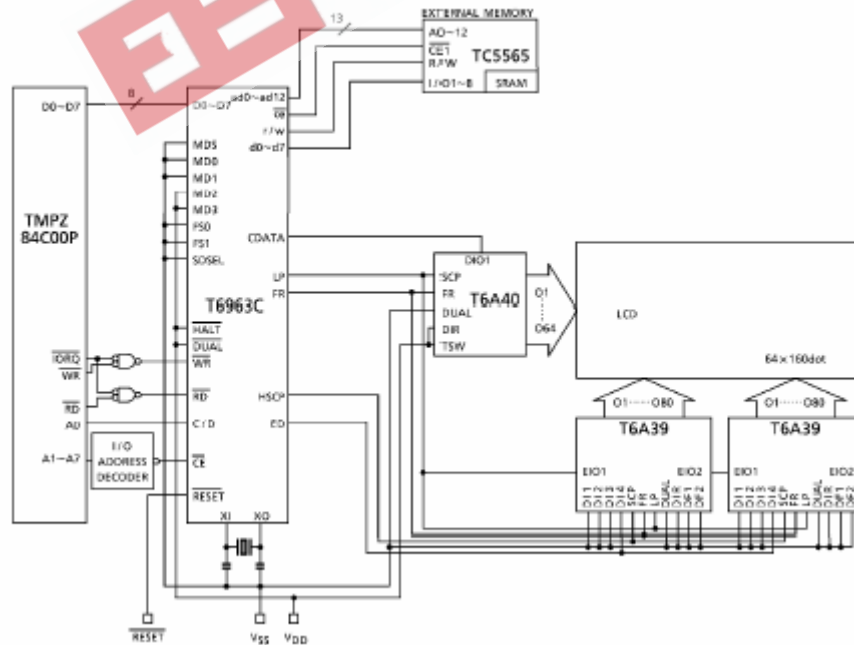

4. RELIABILITY

Environmental Test				
No	Test Item	Content of Test	Test Condition	Applicable Standard
1	High temperature storage	Endurance test applying the high storage temperature for a long time.	60 °C 200 hrs	-----
2	Low temperature storage	Endurance test applying the low storage temperature for a long time.	-10 °C 200 hrs	-----
3	High temperature operation	Endurance test applying the electric stress (Voltage & Current) and the thermal stress to the element for a long time.	50 °C 200 hrs	-----
4	Low temperature operation	Endurance test applying the electric stress under low temperature for a long time.	0 °C 200 hrs	-----
5	High temperature / Humidity storage	Endurance test applying the high temperature and high humidity storage for a long time.	60 °C , 90 %RH 96 hrs	MIL-202E-103B JIS-C5023
6	High temperature / Humidity operation	Endurance test applying the electric stress (Voltage & Current) and temperature / humidity stress to the element for a long time.	40 °C , 90 %RH 96 hrs	MIL-202E-103B JIS-C5023
7	Temperature cycle	Endurance test applying the low and high temperature cycle. $ \begin{array}{c} -20^{\circ}\text{C} \rightleftharpoons 25^{\circ}\text{C} \rightleftharpoons 70^{\circ}\text{C} \\ 30\text{min} \quad \quad 5\text{min.} \quad \quad 30\text{min} \\ \longleftarrow \quad \quad \quad \quad \quad \quad \quad \longrightarrow \\ \text{1 cycle} \end{array} $	-10°C / 60°C 10 cycles	-----
Mechanical Test				
8	Vibration test	Endurance test applying the vibration during transportation and using.	10~22Hz → 1.5mmp-p 22~500Hz → 1.5G Total 0.5hrs	MIL-202E-201A JIS-C5025 JIS-C7022-A-10
9	Shock test	Constructional and mechanical endurance test applying the shock during transportation.	50G Half sign wave 11 msdc 3 times of each direction	MIL-202E-213B
10	Atmospheric pressure test	Endurance test applying the atmospheric pressure during transportation by air.	115 mbar 40 hrs	MIL-202E-105C
Others				
11	Static electricity test	Endurance test applying the electric stress to the terminal.	VS=800V , RS=1.5 kΩ CS=100 pF 1 time	MIL-883B-3015.1

*** Supply voltage for logic system = VDD. Supply voltage for LCD system = Operating voltage at 25°C

■ LCD Panel Service Life

Definition of panel service life

- 100,000 hours minimum at 25° C ±10%
- Contrast becomes 30% of initial value
- Current consumption becomes three times higher than initial value
- Remarkable alignment deterioration occurs in LCD cell layer
- Unusual operation occurs in display functions

5. PRECAUTIONS FOR USING LCD MODULES

Installing LCD Modules

The hole in the printed circuit board is used to fix LCM as shown in the picture below. Attend to the following items when installing the LCM.

- 1) Cover the surface with a transparent protective plate to protect the polarizer and LC cell.

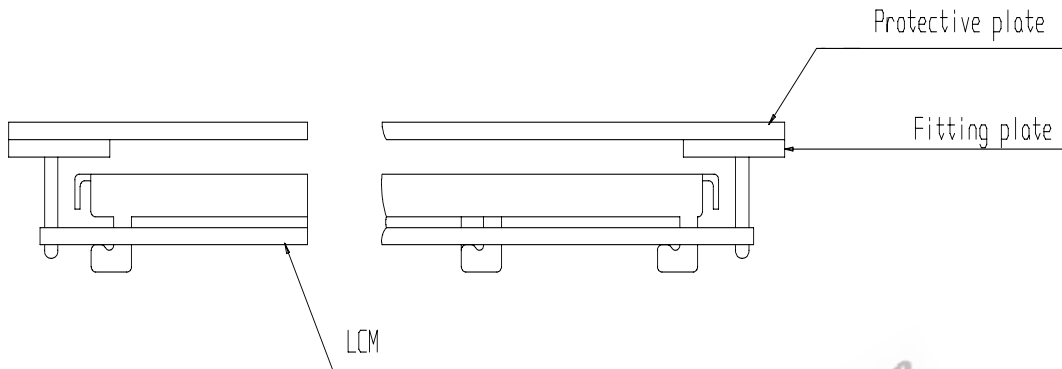

- 2) When assembling the LCM into other equipment, the spacer to the bit between the LCM and the fitting plate should have enough height to avoid causing stress to the module surface, refer to the individual specifications for measurements. The measurement tolerance should be $\pm 0.1\text{mm}$.

Precaution for Handling LCD Modules

Since LCM has been assembled and adjusted with a high degree of precision, avoid applying excessive shocks to the module or making any alterations or modifications to it.

- 1) Cover the surface with a transparent protective plate to protect the polarizer and LC cell.
- 2) Do not alter, modify or change the shape of the tab on the metal frame.
- 3) Do not make extra holes on the printed circuit board, modify its shape or change the positions of components to be attached.
- 4) Do not damage or modify the pattern writing on the printed circuit board.
- 5) Absolutely do not modify the zebra rubber strip (conductive rubber) or heat seal connector.
- 6) Except for soldering the interface, do not make any alterations or modifications with a soldering iron.
- 7) Do not drop, bend or twist LCM.

Electro-Static Discharge Control

Since this module uses a CMOS LSI, the same careful attention should be paid to electrostatic discharge as for an ordinary CMOS IC.

- 1) Make certain that you are grounded when handling LCM.
- 2) Before remove LCM from its packing case or incorporating it into a set, be sure the module and your body have the same electric potential.
- 3) When soldering the terminal of LCM, make certain the AC power source for the soldering iron does not leak.
- 4) When using an electric screwdriver to attach LCM, the screwdriver should be of ground potentiality to minimize as much as possible any transmission of electromagnetic waves produced sparks coming from the commutator of the motor.
- 5) As far as possible make the electric potential of your work clothes and that of the work bench the ground potential.
- 6) To reduce the generation of static electricity be careful that the air in the work is not too dried. A relative humidity of 50%-60% is recommended.

Precaution for soldering to the LCM

- 1) Observe the following when soldering lead wire, connector cable and etc. to the LCM.
 - a) Soldering iron temperature : $280^{\circ}\text{C} \pm 10^{\circ}\text{C}$.
 - b) Soldering time : 3-4 sec.
- 2) Solder : eutectic solder.

- 3) If soldering flux is used, be sure to remove any remaining flux after finishing to soldering operation. (This does not apply in the case of a non-halogen type of flux.) It is recommended that you protect the LCD surface with a cover during soldering to prevent any damage due to flux spatters.
- 4) When soldering the electroluminescent panel and PC board, the panel and board should not be detached more than three times. This maximum number is determined by the temperature and time conditions mentioned above, though there may be some variance depending on the temperature of the soldering iron.
- 5) When remove the electroluminescent panel from the PC board, be sure the solder has completely melted, the soldered pad on the PC board could be damaged.

Precautions for Operation

- 1) Viewing angle varies with the change of liquid crystal driving voltage (VO). Adjust VO to show the best contrast.
- 2) Driving the LCD in the voltage above the limit shortens its life.
- 3) Response time is greatly delayed at temperature below the operating temperature range. However, this does not mean the LCD will be out of the order. It will recover when it returns to the specified temperature range.
- 4) If the display area is pushed hard during operation, the display will become abnormal. However, it will return to normal if it is turned off and then back on.
- 5) Condensation on terminals can cause an electrochemical reaction disrupting the terminal circuit. Therefore, it must be used under the relative condition of 40°C , 50% RH.
- 6) When turning the power on, input each signal after the positive/negative voltage becomes stable.

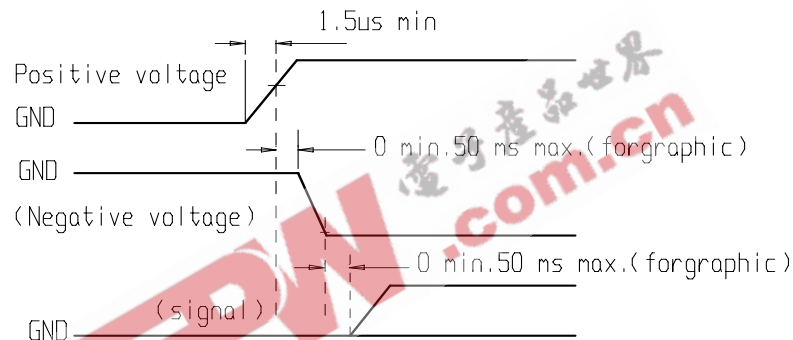

Safety

- If the LCD panel breaks, be careful not to get the liquid crystal in your mouth. If the liquid crystal touches your skin or clothes, wash it off immediately using soap and plenty of water.

Handling

- The display panel is made of glass. Do not subject it to a mechanical shock by dropping it or impact.
- If the display panel is damaged and the liquid crystal substance leaks out, be sure not to get any in your mouth. If the substance contacts your skin or clothes, wash it off using soap and water.
- Do not apply excessive force to the display surface or the adjoining areas since this may cause the color tone to vary.
- The polarizer covering the display surface of the LCD module is soft and easily scratched. Handle this polarizer carefully.
- If the display surface becomes contaminated, breathe on the surface and gently wipe it with a soft dry cloth. If it is heavily contaminated, moisten cloth with one of the following solvents :
 - Isopropyl alcohol
 - Ethyl alcohol
- Solvents other than those above-mentioned may damage the polarizer. Especially, do not use the following.
 - Water
 - Ketone
 - Aromatic solvents
- Exercise care to minimize corrosion of the electrode. Corrosion of the electrodes is accelerated by water droplets, moisture condensation or a current flow in a high-humidity environment.
- Install the LCD Module by using the mounting holes. When mounting the LCD module make sure it is free of twisting, warping and distortion. In particular, do not forcibly pull or bend the I/O cable or the backlight cable.
- Do not attempt to disassemble or process the LCD module.
- NC terminal should be open. Do not connect anything.
- If the logic circuit power is off, do not apply the input signals.

- To prevent destruction of the elements by static electricity, be careful to maintain an optimum work environment.
 - Be sure to ground the body when handling the LCD modules.
 - Tools required for assembling, such as soldering irons, must be properly grounded.
 - To reduce the amount of static electricity generated, do not conduct assembling and other work under dry conditions.
 - The LCD module is coated with a film to protect the display surface. Exercise care when peeling off this protective film since static electricity may be generated.

Storage

- When storing the LCD modules, avoid exposure to direct sunlight or to the light of fluorescent lamps
- Store the module in a dark place where the temperature is $25^{\circ}\text{C} \pm 10^{\circ}\text{C}$ and the humidity below 65% RH.
- Do not store the module near organic solvents or corrosive gases.
- Do not crush, shake, or jolt the module (including accessories).

Cleaning

- Do not wipe the polarizing plate with a dry cloth, as it may scratch the surface.
- Wipe the module gently with soft cloth soaked with a petroleum benzene.
- Do not use ketonic solvents (ketone and acetone) or aromatic solvents (toluene and xylene), as they may damage the polarizing plate.

Others:

- Liquid crystals solidify under low temperature (below the storage temperature range) leading to defective orientation or the generation of air bubbles (black or white). Air bubbles may also be generated if the module is subject to a low temperature.
- If the LCD modules have been operating for a long time showing the same display patterns, the display patterns may remain on the screen as ghost images and a slight contrast irregularity may also appear. A normal operating status can be regained by suspending use for some time. It should be noted that this phenomenon does not adversely affect performance reliability.
- To minimize the performance degradation of the LCD modules resulting from destruction caused by static electricity etc., exercise care to avoid holding the following sections when handling the modules.
 - Exposed area of the printed circuit board.
 - Terminal electrode sections.