

Varistors



QUICK REFERENCE DATA

PARAMETER	VALUE	UNIT
Maximum continuous voltage:		
RMS	14 to 680	V
DC	18 to 895	V
Maximum non-repetitive transient current I_{nrp} ($8 \times 20 \mu s$)	100 to 6500	A
Robustness of terminations	10	N
Drop test:		
Height of fall	1	m
Detailed specification	based on CECC 42000	
Climatic category	40/085/56	

ORDERING INFORMATION

The varistors are available in a number of packaging options:

- Bulk
- On tape on reel
- On tape in ammpack.

The basic ordering code for each option is given in tables titled Varistors on Tape on Reel, Varistors on Tape in Ammpack and Varistors in Bulk. To complete the catalog number and to determine the required operating parameters, see Electrical Data and Ordering Information table.

FEATURES

- Zinc oxide disc, epoxy coated
- Straight leads
- Straight leads with flange (2322 592 and 593 series only)
- Kinked leads.

APPLICATION

- Suppression of transients.

DESCRIPTION

The varistors consist of a disc of low- β ceramic material with two tinned solid copper leads. They are coated with a layer of ochre coloured epoxy, which provides electrical, mechanical and climatic protection. The encapsulation is resistant to all cleaning solvents in accordance with "IEC 60068-2-45".

MOUNTING

The varistors are suitable for processing on automatic insertion and cutting and bending equipment.

Varistors with flanged leads provide better positioning on printed-circuit boards (PCB) and more accurate control over component height. This is important for hand mounting and automatic insertion techniques; see Outlines of flanged leads drawing.

Soldering

≤ 240 °C; duration ≤ 5 s.

Resistance to heat

≤ 260 °C; duration ≤ 5 s.

MARKING

The varistors are marked with the following information:

- Maximum continuous RMS voltage
- Series number (592, 593, 594, 595 or 596)
- Manufacturers logo
- Date of manufacture.

INFLAMMABILITY

The varistors are non-flammable.

ELECTRICAL DATA AND ORDERING INFORMATION

MAXIMUM CONTINUOUS VOLTAGE		VOLTAGE ⁽³⁾ at 1 mA	MAXIMUM VOLTAGE at STATED CURRENT		MAXIMUM ENERGY ⁽⁴⁾ (10 × 1000 μs)	MAXIMUM NON-REP. TRANSIENT CURRENT ⁽⁵⁾ I_{nrp} (8 × 20 μs)	TYPICAL CAPACITANCE at 1 kHz	CATALOG NUMBERS(1)
RMS ⁽²⁾ (V)	DC (V)		V (V)	I (A)				
14	18	22	48	1.0	0.5	100	1300	592 .1406 ⁽⁶⁾
			43	2.5	1.7	250	2800	593 .1406 ⁽⁶⁾
			43	5.0	4.3	500	6000	594 .1406 ⁽⁶⁾
			43	10.0	5.4	1000	15000	595 .1406 ⁽⁶⁾
17	22	27	60	1.0	0.7	100	1050	592 .1706 ⁽⁶⁾
			53	2.5	2.0	250	2000	593 .1706 ⁽⁶⁾
			53	5.0	5.3	500	4000	594 .1706 ⁽⁶⁾
			53	10.0	6.9	1000	10000	595 .1706 ⁽⁶⁾



ELECTRICAL DATA AND ORDERING INFORMATION

MAXIMUM CONTINUOUS VOLTAGE		VOLTAGE ⁽³⁾ at 1 mA (V)	MAXIMUM VOLTAGE at STATED CURRENT		MAXIMUM ENERGY ⁽⁴⁾ (10 × 1000 µs) (J)	MAXIMUM NON-REP. TRANSIENT CURRENT ⁽⁵⁾ I _{trp} (8 × 20 µs) (A)	TYPICAL CAPACITANCE at 1 KHZ (PF)	CATALOG NUMBERS ⁽¹⁾ 2322
RMS ⁽²⁾ (V)	DC (V)		V (V)	I (A)				
20	26	33	73	1.0	0.8	100	900	592 .2006 ⁽⁶⁾
			65	2.5	2.5	250	1500	593 .2006 ⁽⁶⁾
			65	5.0	6.5	500	3000	594 .2006 ⁽⁶⁾
25	31	39	65	10.0	8.8	1000	7500	595 .2006 ⁽⁶⁾
			86	1.0	0.9	100	500	592 .2506 ⁽⁶⁾
			77	2.5	3.0	250	1350	593 .2506 ⁽⁶⁾
30	38	47	77	5.0	7.7	500	2600	594 .2506 ⁽⁶⁾
			77	10.0	9.4	1000	6500	595 .2506 ⁽⁶⁾
			96	1.0	1.1	100	700	592 .3006 ⁽⁶⁾
35	45	56	93	2.5	3.6	250	1600	593 .3006 ⁽⁶⁾
			93	5.0	9.2	500	2700	594 .3006 ⁽⁶⁾
			90	10.0	12.0	1000	6000	595 .3006 ⁽⁶⁾
40	56	68	123	1.0	1.4	100	560	592 .3506 ⁽⁶⁾
			115	2.5	4.4	250	1300	593 .3506 ⁽⁶⁾
			110	5.0	11.0	500	2200	594 .3506 ⁽⁶⁾
50	65	82	105	10.0	14.0	1000	4800	595 .3506 ⁽⁶⁾
			145	1.0	1.6	100	460	592 .4006 ⁽⁶⁾
			135	2.5	5.2	250	1000	593 .4006 ⁽⁶⁾
60	85	100	130	5.0	13.0	500	1800	594 .4006 ⁽⁶⁾
			130	10.0	17.0	1000	3800	595 .4006 ⁽⁶⁾
			145	5.0	2.6	400	370	592 .5006 ⁽⁶⁾
75	100	120	140	10.0	7.0	1200	900	593 .5006 ⁽⁶⁾
			140	25.0	12.0	2500	1500	594 .5006 ⁽⁶⁾
			140	50.0	21.0	4500	3100	595 .5006 ⁽⁶⁾
95	125	150	165	5.0	2.9	400	290	592 .6006 ⁽⁶⁾
			165	10.0	8.3	1200	700	593 .6006 ⁽⁶⁾
			165	25.0	15.0	2500	1200	594 .6006 ⁽⁶⁾
130	170	205	165	50.0	24.0	4500	2300	595 .6006 ⁽⁶⁾
			165	100.0	56.0	6500	4700	596 .6006
			190	5.0	3.4	400	240	592 .7506 ⁽⁶⁾
140	180	220	200	10.0	10.0	1200	530	593 .7506 ⁽⁶⁾
			200	25.0	18.0	2500	1000	594 .7506 ⁽⁶⁾
			200	50.0	29.0	4500	1900	595 .7506 ⁽⁶⁾
150	200	240	200	100.0	64.0	6500	3900	596 .7506
			230	5.0	4.1	400	180	592 .9506 ⁽⁶⁾
			250	10.0	13.0	1200	450	593 .9506 ⁽⁶⁾
175	225	275	250	25.0	22.0	2500	800	594 .9506 ⁽⁶⁾
			250	50.0	37.0	4500	1500	595 .9506 ⁽⁶⁾
			250	100.0	88.0	6500	3000	596 .9506
230	300	360	310	5.0	5.5	400	130	592 .1316 ⁽⁶⁾
			340	10.0	17.0	1200	320	593 .1316 ⁽⁶⁾
			340	25.0	30.0	2500	580	594 .1316 ⁽⁶⁾
140	180	220	340	50.0	56.0	4500	1050	595 .1316 ⁽⁶⁾
			340	100.0	114.0	6500	2100	596 .1316
			350	5.0	6.3	400	120	592 .1416 ⁽⁶⁾
150	200	240	370	10.0	21.0	1200	290	593 .1416 ⁽⁶⁾
			370	25.0	33.0	2500	540	594 .1416 ⁽⁶⁾
			370	50.0	57.0	4500	950	595 .1416 ⁽⁶⁾
175	225	275	360	100.0	124.0	6500	1900	596 .1416
			395	5.0	7.1	400	110	592 .1516 ⁽⁶⁾
			400	10.0	20.0	1200	270	593 .1516 ⁽⁶⁾
230	300	360	400	25.0	36.0	2500	490	594 .1516 ⁽⁶⁾
			400	50.0	59.0	4500	850	595 .1516 ⁽⁶⁾
			395	100.0	134.0	6500	1700	596 .1516
175	225	275	410	5.0	7.3	400	90	592 .1716 ⁽⁶⁾
			455	10.0	23.0	1200	230	593 .1716 ⁽⁶⁾
			455	25.0	41.0	2500	430	594 .1716 ⁽⁶⁾
230	300	360	455	50.0	67.0	4500	750	595 .1716 ⁽⁶⁾
			455	100.0	158.0	6500	1500	596 .1716
			560	5.0	10.0	400	70	592 .2316 ⁽⁶⁾
230	300	360	600	10.0	30.0	1200	170	593 .2316 ⁽⁶⁾
			600	25.0	54.0	2500	320	594 .2316 ⁽⁶⁾
			600	50.0	88.0	4500	540	595 .2316 ⁽⁶⁾
230	300	360	595	100.0	208.0	6500	1100	596 .2316

www.Datasheet.in



ELECTRICAL DATA AND ORDERING INFORMATION								
MAXIMUM CONTINUOUS VOLTAGE		VOLTAGE ⁽³⁾ at 1 mA	MAXIMUM VOLTAGE at STATED CURRENT		MAXIMUM ENERGY ⁽⁴⁾ (10 × 1000 μs)	MAXIMUM NON-REP. TRANSIENT CURRENT ⁽⁵⁾ I _{nrp} (8 × 20 μs)	TYPICAL CAPACITANCE at 1 kHz	CATALOG NUMBERS(1)
RMS ⁽²⁾ (V)	DC (V)	(V)	V (V)	I (A)	(J)	(A)	(PF)	2322
250	320	390	600	5.0	11.0	400	60	592 .2516(6)
			650	10.0	33.0	1200	160	593 .2516(6)
			650	25.0	58.0	2500	300	594 .2516(6)
			650	50.0	96.0	4500	480	595 .2516(6)
			650	100.0	240.0	6500	960	596 .2516
275	350	430	695	5.0	12.0	400	55	592 .2716(6)
			710	10.0	36.0	1200	140	593 .2716(6)
			710	25.0	63.0	2500	270	594 .2716(6)
			710	50.0	104.0	4500	440	595 .2716(6)
			710	100.0	264.0	6500	900	596 .2716
300	385	470	750	5.0	13.0	400	50	592 .3016(6)
			800	10.0	40.0	1200	130	593 .3016(6)
			800	25.0	71.0	2500	240	594 .3016(6)
			800	50.0	117.0	4500	400	595 .3016(6)
			775	100.0	280.0	6500	810	596 .3016
320	420	510	800	5.0	15.0	400	45	592 .3216(6)
			850	10.0	44.0	1200	120	593 .3216(6)
			850	25.0	77.0	2500	220	594 .3216(6)
			850	50.0	120.0	4500	370	595 .3216(6)
			842	100.0	296.0	6500	750	596 .3216
385	505	620	1000	5.0	18.0	400	40	592 .3816(6)
			1025	10.0	51.0	1200	95	593 .3816(6)
			1025	25.0	67.0	2500	180	594 .3816(6)
			1025	50.0	110.0	4500	280	595 .3816(6)
			1025	100.0	328.0	6500	570	596 .3816
420	560	680	1100	5.0	20.0	400	35	592 .4216(6)
			1120	10.0	56.0	1200	85	593 .4216(6)
			1120	25.0	73.0	2500	165	594 .4216(6)
			1120	50.0	120.0	4500	250	595 .4216(6)
			1120	100.0	344.0	6500	510	596 .4216
460	615	750	1200	5.0	21.0	400	30	592 .4616(6)
			1240	10.0	63.0	1200	75	593 .4616(6)
			1240	25.0	82.0	2500	150	594 .4616(6)
			1240	50.0	135.0	4500	225	595 .4616(6)
			1240	100.0	360.0	6500	460	596 .4616
510	670	820	1355	25.0	89.0	2500	135	594 .5116(6)
			1355	50.0	145.0	4500	220	595 .5116(6)
			1355	100.0	376.0	6500	450	596 .5116
550	745	910	1500	25.0	98.0	2500	120	594 .5516(6)
			1500	50.0	160.0	4500	180	595 .5516(6)
			1500	100.0	408.0	6500	370	596 .5516
625	825	1000	1650	100.0	448.0	6500	320	596 .6216
680	895	1100	1815	100.0	496.0	6500	270	596 .6816

Notes

- Lists with products certified according to UL (E98144), VDE (122380E), CSA (219883) and CECC (42201-001) are available at www.vishay.com or on request.
- The sinusoidal voltage is assumed as the normal operating condition. If a non-sinusoidal voltage is present, type selection should be based on multiplying the peak voltage by a factor of 0.707.
- The voltage measured at 1 mA meets the requirements of "paragraph 4.3 of CECC specification 42000". The tolerance on the voltage at 1 mA is ±10%.
- High energy surges are generally of longer duration. The maximum energy for one pulse of 10 × 1000 μs is given as a reference for longer duration pulses. This pulse can be characterised by peak current (I_p) and pulse width t₂ (virtual time of half I_p value, following "IEC 60060-2, section 6"). If V_p is the clamping voltage corresponding to I_p, the energy absorbed in the varistor is determined by the formula:

$$E = K \times V_p \times I_p \times t_2$$
 where:
 a) K is dependent on the value of t₂ when the value of t₁ is between 8 μs and 10 μs; see Peak Current as a Function of Pulse Width drawing.
- A current wave of 8 × 20 μs (requirement of "paragraph B.2.10.1 of CECC specification 42000") is used as a standard for pulse current and clamping voltage ratings. The maximum non-repetitive transient current is given for one pulse applied during the life of the component.
- Replace the last digit of the catalog number with a '7' for ordering on tape in ammpack.



ELECTRICAL CHARACTERISTICS

ELECTRICAL DATA		
PARAMETER	VALUE	UNIT
Maximum continuous voltage:		
RMS	14 to 680	V
DC	18 to 895	V
Maximum non-repetitive transient current (I_{nrp}) ($8 \times 20 \mu s$):		
2322 592	100 or 400	A
2322 593	250 or 1200	A
2322 594	500 or 2500	A
2322 595	1000 or 4500	A
2322 596	6500	A
Thermal resistance:		
2322 592	≈ 80	K/W
2322 593	≈ 70	K/W
2322 594	≈ 60	K/W
2322 595	≈ 50	K/W
2322 596	≈ 40	K/W
Maximum dissipation:		
2322 592	100	mW
2322 593	250	mW
2322 594	400	mW
2322 595	600	mW
2322 596	1000	mW
Temperature coefficient of voltage at 1 mA maximum	-0.065	%/K
Voltage proof between interconnected leads and case	2500	V
Climatic category	40/085/56	

DERATING CURVE

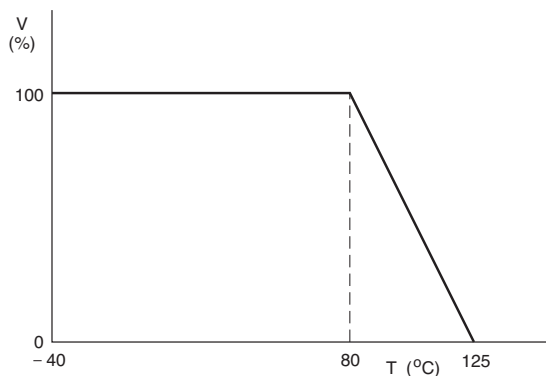

PEAK CURRENT AS A FUNCTION OF PULSE WIDTH

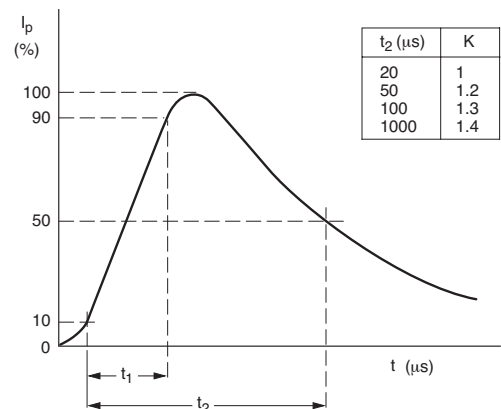

VARISTORS IN BULK					
TYPE	2322 592 Ø5 mm 14 V to 460 V	2322 593 Ø7 mm 14 V to 460 V	2322 594 Ø10 mm 14 V to 550 V	2322 595 Ø14 mm 14 V to 550 V	2322 596 Ø20 mm 60 V to 680 V
Straight leads; see Outline of components with straight leads drawing(1)	5...6	5...6	5...6	5...6	5...6
Straight leads with flange; see Outline of components with flanged leads drawing	7...6	7...6	-	-	-
Kinked leads; see Outline of components with kinked leads drawing	6...6	6...6	6...6	6...6	6...6
Package quantities	250	250	250	100 and 250	1 000

Note

1. Outline of the Ø20 mm differs from the other dimensions.

DIMENSIONS in millimeters

Outline of component with straight leads.

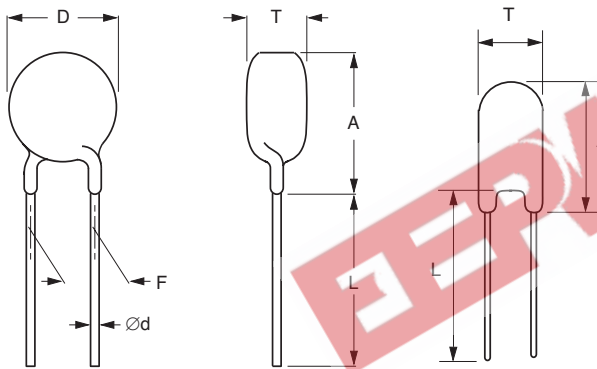

For dimensions, see Component Dimensions and catalog Numbers table.

Ø20 mm only.

Outline of component with kinked leads.

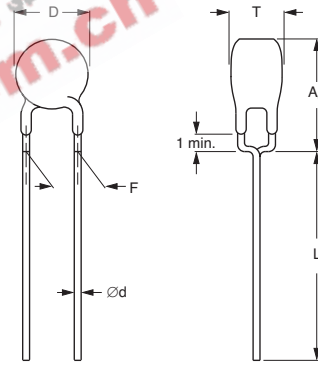

For dimensions, see Component Dimensions and catalog Numbers table.

Outline of component with flanged leads.

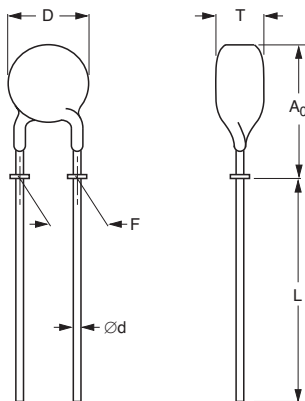

For dimensions, see Component Dimensions and catalog Numbers table.

Outline of flanged leads.

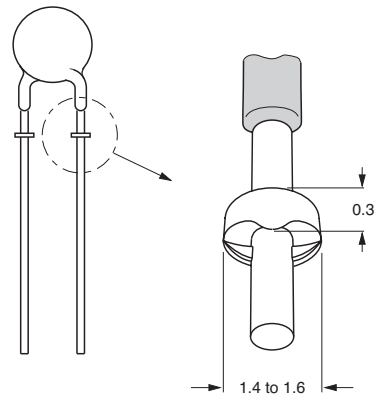



COMPONENT DIMENSIONS AND CATALOG NUMBERS in millimeters								
D MAX.	A MAX.	A ₀ MAX.	L MIN.	T MAX.	T MIN.	ØD	F	CATALOG NUMBER
7.0	9.0	11.0	27.0	6	4.1	0.6 ±0.05	5 +0.6/-0.1	2322 592
9.0	11.0	13.0	27.0	6	4.1	0.6 ±0.05	5 +0.6/-0.1	2322 593
13.5	15.5	18.0	17.0	7	4.4	0.8 ±0.05	7.5 ±0.8	2322 594
17.0	19.0	23.0	16.0	7	4.4	0.8 ±0.05	7.5 ±0.8	2322 595
23.0	25.0	28.0	24.0	7	5.0	1.0 ±0.05	10 ±0.8	2322 596

VARISTORS ON TAPE ON REEL				
TYPE	2322 592 Ø5 mm 14 V to 460 V	2322 593 Ø7 mm 14V to 460 V	2322 594 Ø10 mm 14 V to 550 V	2322 595 Ø14 mm 14V to 460 V
Straight leads: H = 18 mm (2322 594 and 2322 595); see Taped version with straight leads (only for 2322 594 and 2322 595 series) drawing H = 20 mm (2322 592 and 2322 593); see Taped version with straight leads (only for 2322 592 and 2322 593 series) drawing	- 0...6	- 0...6	0...6 -	0...6 -
Straight leads with flange; H ₀ = 16 mm; see Taped version with flanged leads (only for 2322 592 and 2322 593 series) drawing	1...6	1...6	-	-
Straight leads with flange; H ₀ = 18.25 mm; see Taped version with flanged leads (only for 2322 592 and 2322 593 series) drawing	2...6	2...6	-	-
Kinked leads; H ₀ = 18.25 mm; see Taped version with kinked leads (only for 2322 594 and 2322 595 series) drawing	3...6	3...6	3...6	3...6
Kinked leads; H ₀ = 16 mm; see Taped version with kinked leads (only for 2322 592 and 2322 593 series) drawing	8...6	8...6	8...6	8...6
Package quantities				
14 V to 385 V	3000	3000	1500	1500
≥420 V	-	-	-	1000
510 V to 550 V	-	-	1200	1200

PACKAGING

TAPED VERSION WITH STRAIGHT LEADS (only for 2322 592 and 2322 593 series).

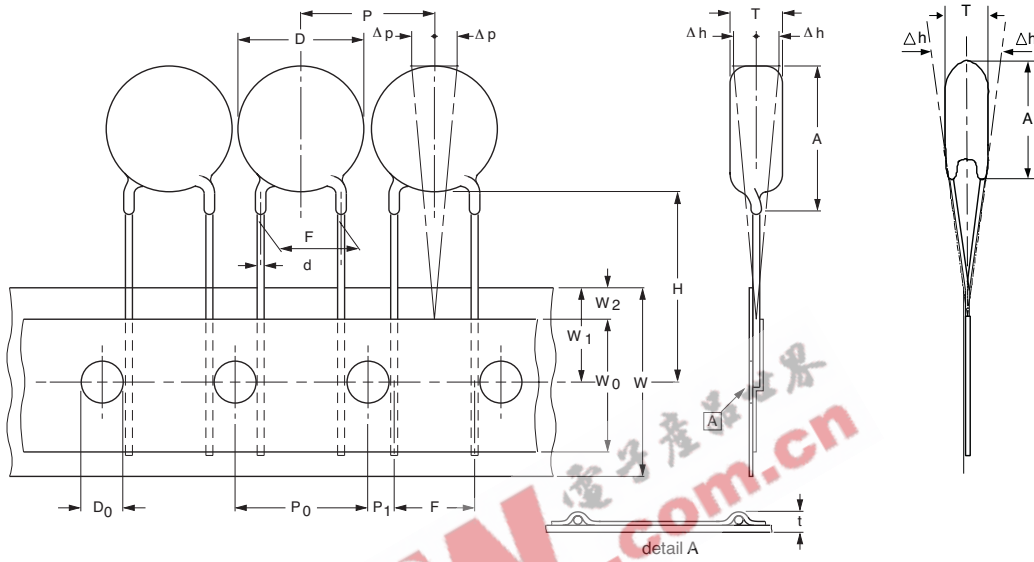

TAPED VERSION WITH STRAIGHT LEADS (only for 2322 594 and 2322 595 series).

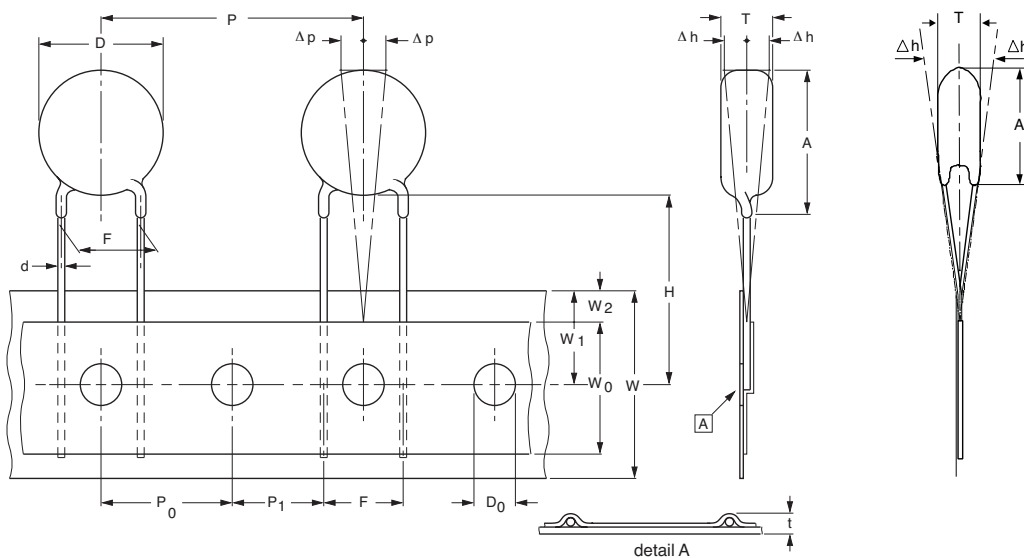

TAPED VERSION WITH KINKED LEADS

(only for 2322 592 and 2322 593 series).

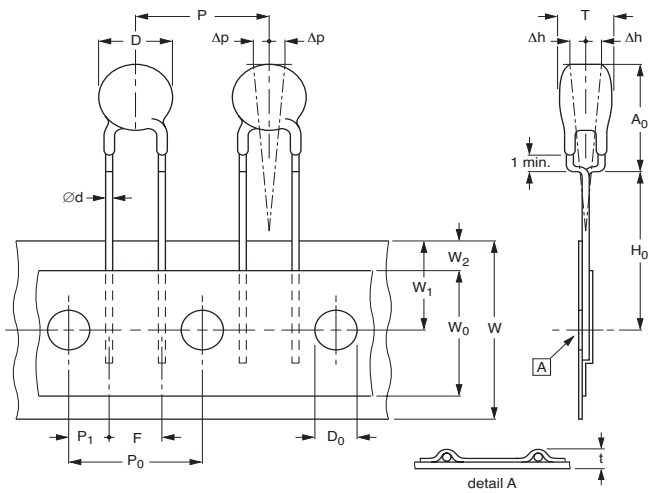

For dimensions, see Taping data table.

TAPED VERSION WITH KINKED LEADS

(only for 2322 594 and 2322 595 series).

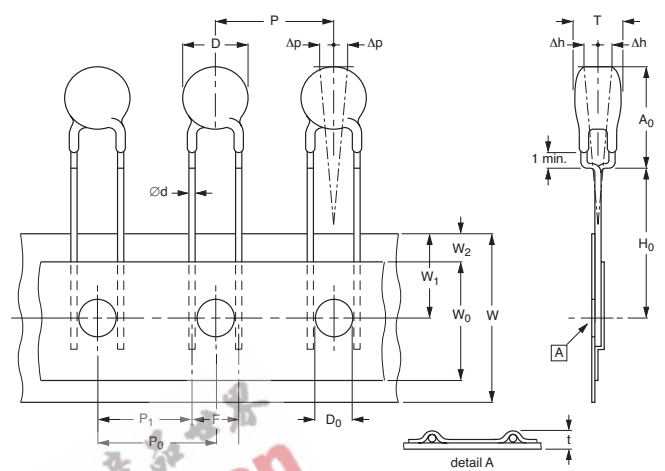

For dimensions, see Taping data table.

TAPED VERSION WITH FLANGED LEADS

(only for 2322 592 and 2322 593 series).

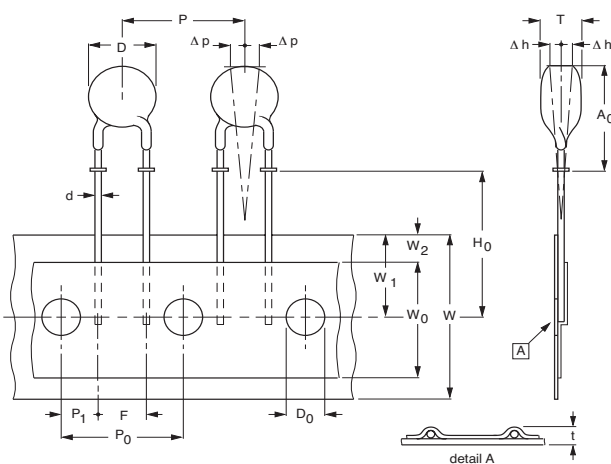

For dimensions, see Taping data table.

DIMENSIONS OF REELS in millimeters

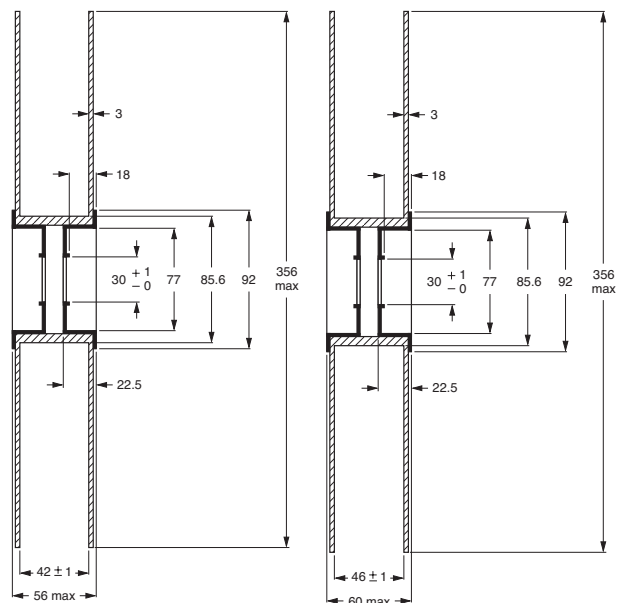



TAPING DATA (based on "IEC 60286-2")				
SYMBOL	PARAMETER	DIMENSIONS NOMINAL (mm)	TOLERANCE (mm)	REMARKS
D	body diameter	see Component Dimensions table		
T	total thickness	see Component Dimensions table		
A ₀ ; A	mounting height	see Component Dimensions table		
∅d	lead diameter	see Component Dimensions table		
F	lead to lead distance	see Component Dimensions table		guaranteed between component and tape
P	component pitch	12.7 or 25.4	±1.0	
P ₀	feed hole pitch	12.7	±0.3	cumulative pitch error ±1
P ₁	feed hole centre to lead centre	3.85 or 8.95	±0.7	guaranteed between component and tape
Δp	component alignment	0.0	±1.3	
Δh	component alignment	0.0	±2.0	
W	tape width	18.0	+1.0/-0.5	
W ₀	hold down tape width	≥12.5		
W ₁	hole position	9.0	±0.5	
W ₂	hold down tape position	≤3.0		
H	height between component and tape centre	18.0	+2.0/-0.0	straight lead version 2322 594 and 2322 595
		20.0	+2.0/-0.0	straight lead version 2322 592 and 2322 593
H ₀	lead-wire flange height	16.0 or 18.25	±0.5	flanged and kinked lead versions
D ₀	feed hole diameter	4.0	±0.2	
t	total tape thickness	≤1.4		with cardboard tape 0.5 ±0.1 mm

VARISTORS ON TAPE IN AMMOPACK				
TYPE	2322 592 ∅MM 14 V TO 460 V	2322 593 ∅7 MM 14 V TO 460 V	2322 594 ∅10 MM 14 V TO 550 V	2322 595 ∅14 MM 14V TO 550 V
Straight leads; H = 18 or 20 mm; see Taped version with straight leads (only for 2322 592 and 2322 593 series) and Taped version with straight leads (only for 2322 594 and 2322 595 series) drawings	0...7	0...7	0...7	0...7
Straight leads with flange; H ₀ = 16 mm; see Taped version with flanged leads (only for 2322 592 and 2322 593 series) drawing	1...7	1...7	-	-
Straight leads with flange; H ₀ = 18.25 mm; see Taped version with flanged leads (only for 2322 592 and 2322 593 series) drawing	2...7	2...7	-	-
Kinked leads; H ₀ = 18.25 mm; see Taped version with kinked leads (only for 2322 594 and 2322 595 series) drawing	3...7	3...7	3...7	3...7
Kinked leads; H ₀ = 16 mm; see Taped version with kinked leads (only for 2322 592 and 2322 593 series) drawing	8...7	8...7	8...7	8...7
Package quantities				
14 to 175 V	1500	1500	750	750
230 to 460 V	1000	1000	-	-
230 to 300 V	-	-	600	600
320 to 550 V	-	-	500	500

DIMENSIONS OF AMMOPACK in millimeters

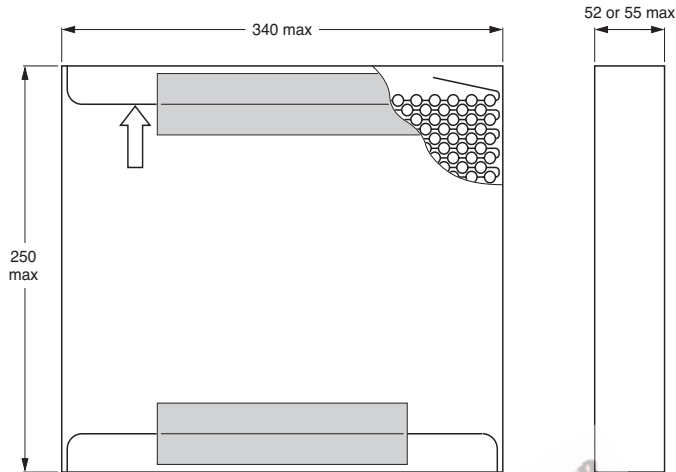

V/I CHARACTERISTICS, 14 V TO 40 V (RMS);
2322 592 series.

V/I CHARACTERISTICS, 50V TO 460 V (RMS);
2322 592 series.

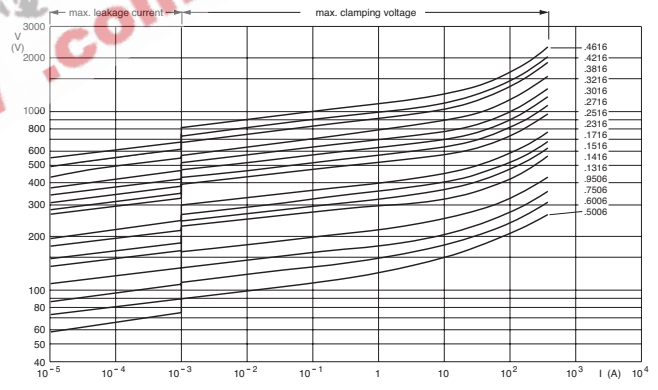
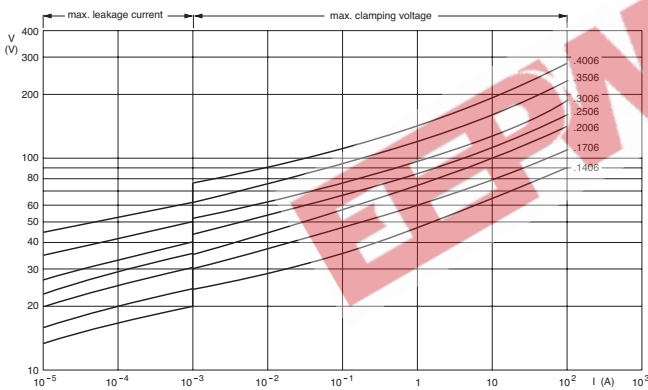

V/I CHARACTERISTICS, 14V TO 40 V (RMS);
2322 593 series.

V/I CHARACTERISTICS, 50V TO 460 V (RMS);
2322 593 series.

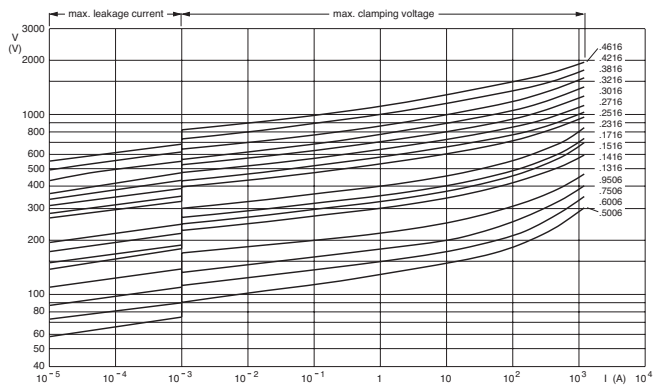
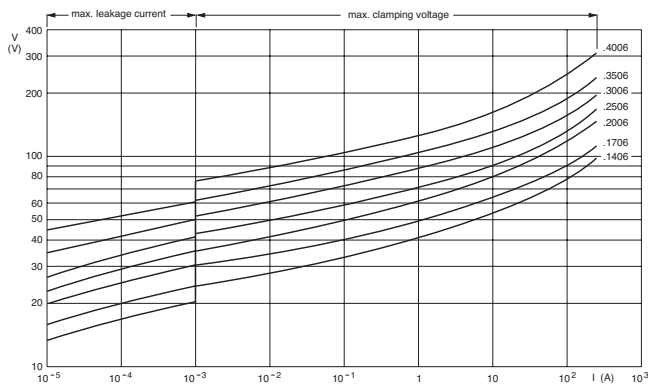

2322 59.

Vishay BCcomponents

Varistors



V/I CHARACTERISTICS, 14V TO 40 V (RMS);
2322 594 series.

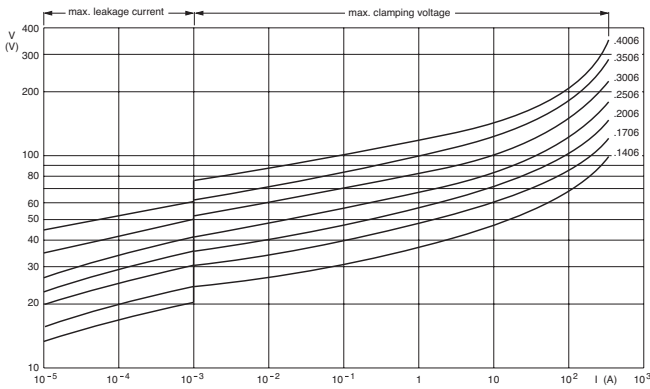

V/I CHARACTERISTICS, 50V TO 550V (RMS);
2322 594 series.

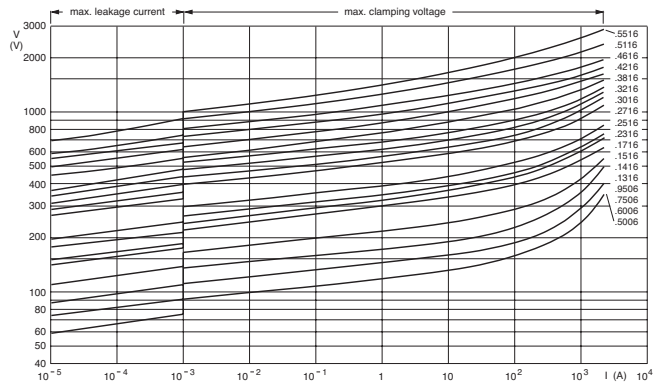

V/I CHARACTERISTICS, 14V TO 40V (RMS);
2322 595 series.

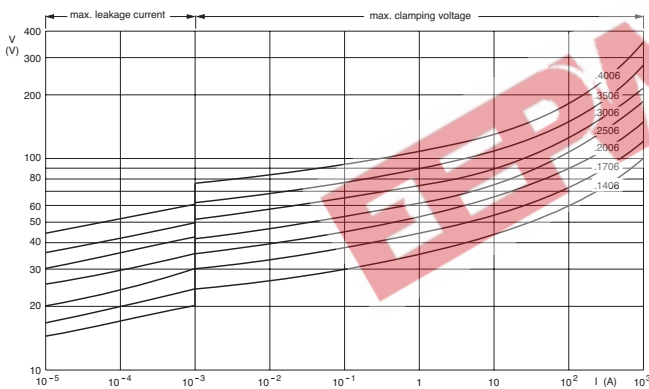

V/I CHARACTERISTICS, 50V TO 550V (RMS);
2322 595 series.

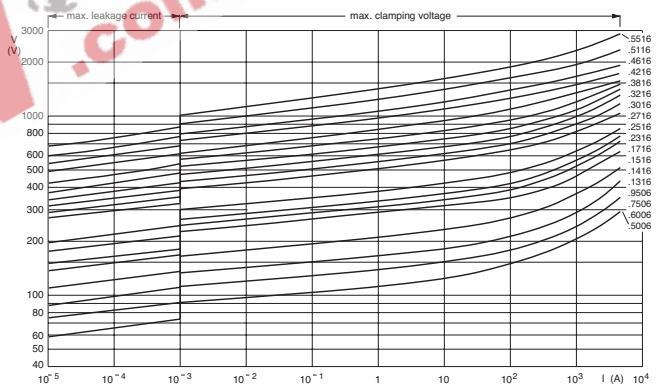

V/I CHARACTERISTICS, 60V TO 95V (RMS);
2322 596 series.

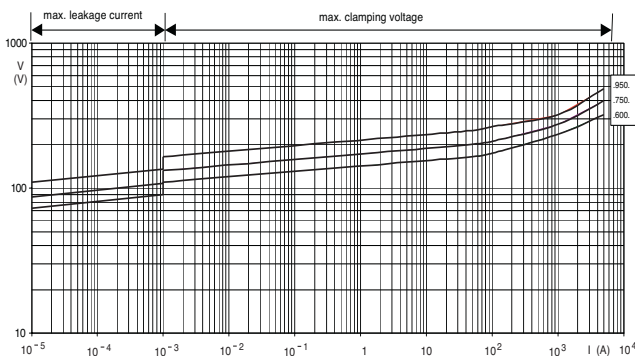

V/I CHARACTERISTICS, 130V TO 175V (RMS);
2322 596 series.

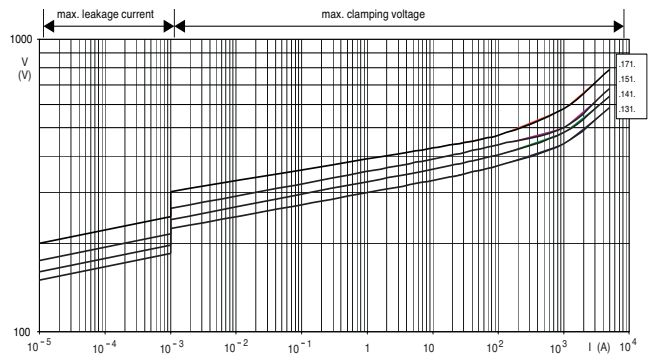



V/I CHARACTERISTICS, 230V TO 275V (RMS);
2322 596 series.

V/I CHARACTERISTICS, 300V TO 385V (RMS);
2322 596 series.

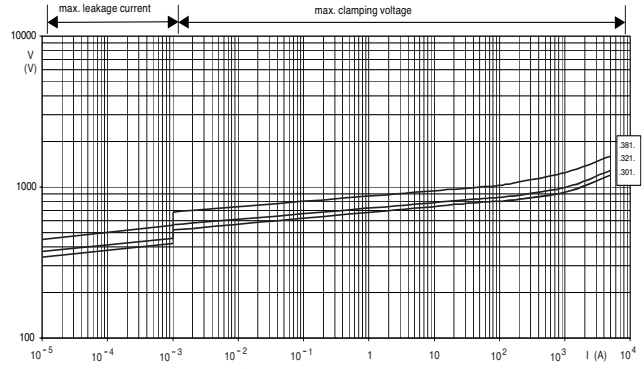
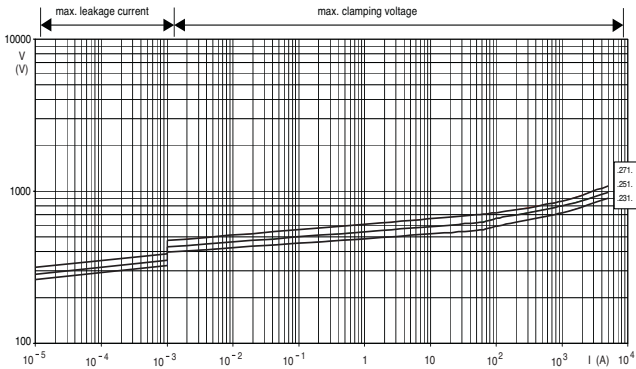

V/I CHARACTERISTICS, 420V TO 680V (RMS);
2322 596 series.

MAXIMUM APPLICABLE TRANSIENT CURRENT AS A FUNCTION OF PULSE DURATION, 14V TO 40V (RMS); 2322 592 series.

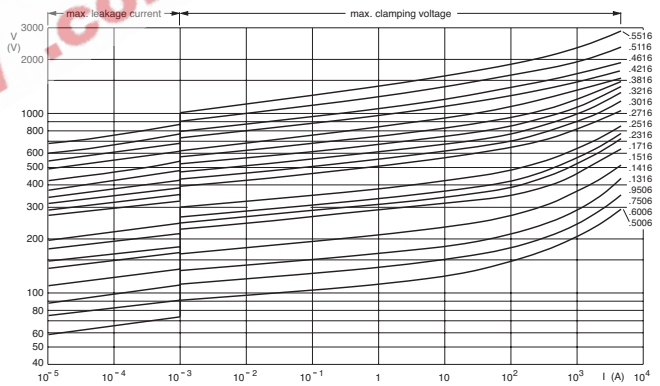
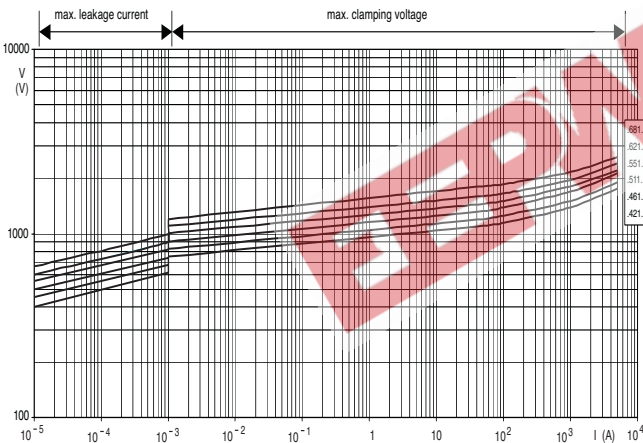

MAXIMUM APPLICABLE TRANSIENT CURRENT AS A FUNCTION OF PULSE DURATION, 50V TO 460V (RMS); 2322 592 series.

MAXIMUM APPLICABLE TRANSIENT CURRENT AS A FUNCTION OF PULSE DURATION, 14V TO 40V (RMS); 2322 593 series.

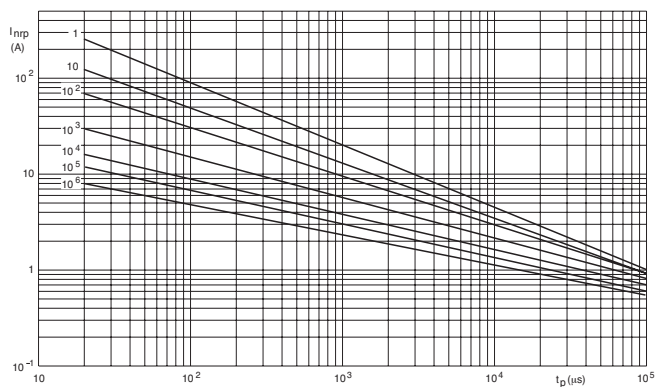
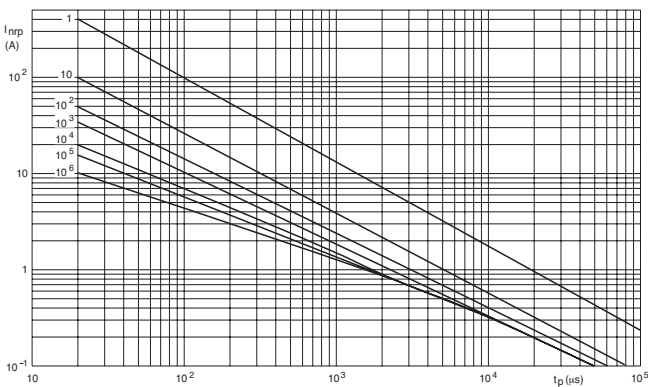



MAXIMUM APPLICABLE TRANSIENT CURRENT AS A FUNCTION OF PULSE DURATION, 50V TO 460V (RMS); 2322 593 series.

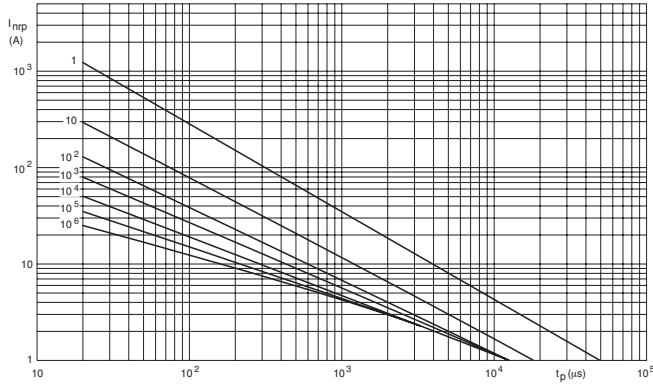

MAXIMUM APPLICABLE TRANSIENT CURRENT AS A FUNCTION OF PULSE DURATION, 14V TO 40V (RMS); 2322 594 series.

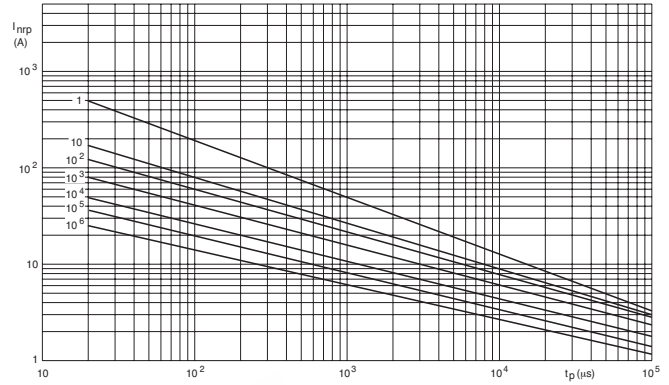

MAXIMUM APPLICABLE TRANSIENT CURRENT AS A FUNCTION OF PULSE DURATION, 50V TO 320V (RMS); 2322 594 series.

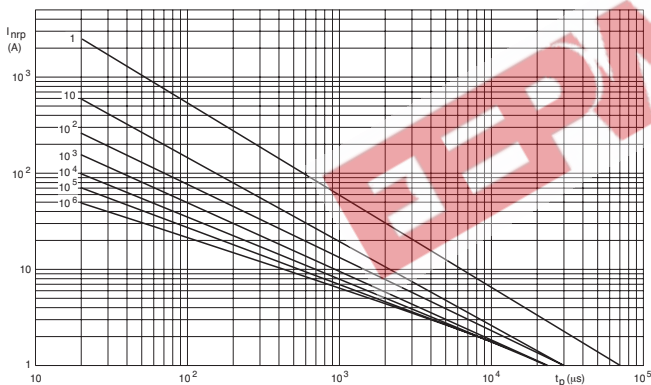

MAXIMUM APPLICABLE TRANSIENT CURRENT AS A FUNCTION OF PULSE DURATION, 385V TO 550V (RMS); 2322 594 series.

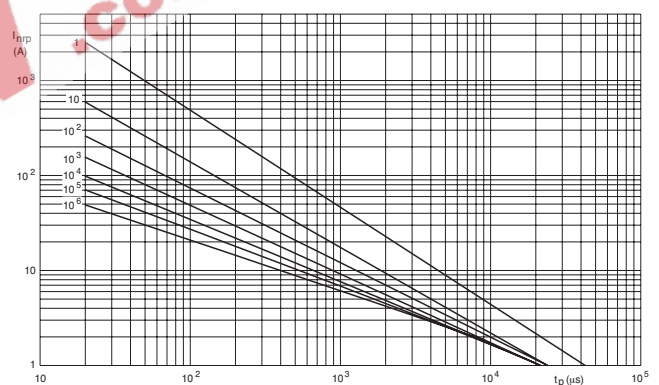

MAXIMUM APPLICABLE TRANSIENT CURRENT AS A FUNCTION OF PULSE DURATION, 14V TO 40V (RMS); 2322 595 series.

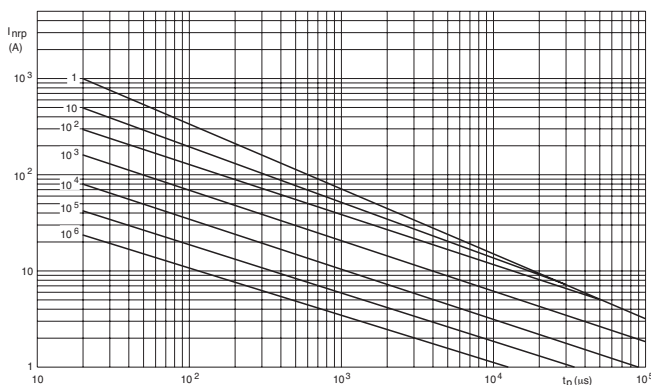

MAXIMUM APPLICABLE TRANSIENT CURRENT AS A FUNCTION OF PULSE DURATION, 50V TO 320V (RMS); 2322 595 series.

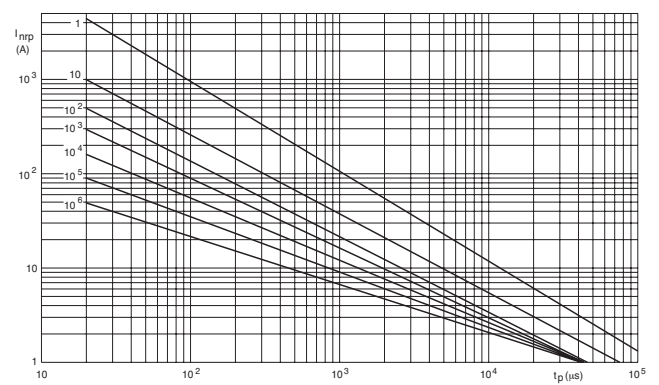



MAXIMUM APPLICABLE TRANSIENT CURRENT AS A FUNCTION OF PULSE DURATION, 385V TO 550V (RMS); 2322 595 series.

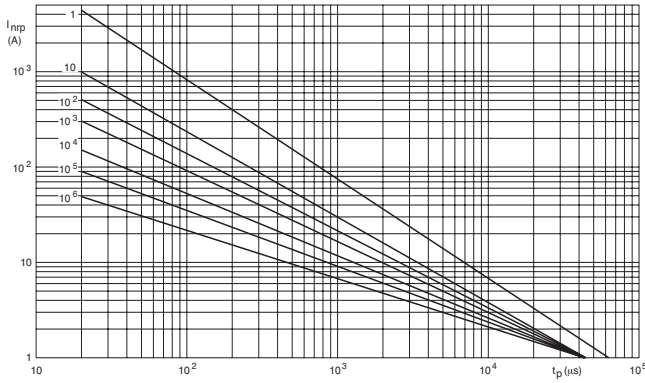

MAXIMUM APPLICABLE TRANSIENT CURRENT AS A FUNCTION OF PULSE DURATION, 60V TO 300V (RMS); 2322 596 series.

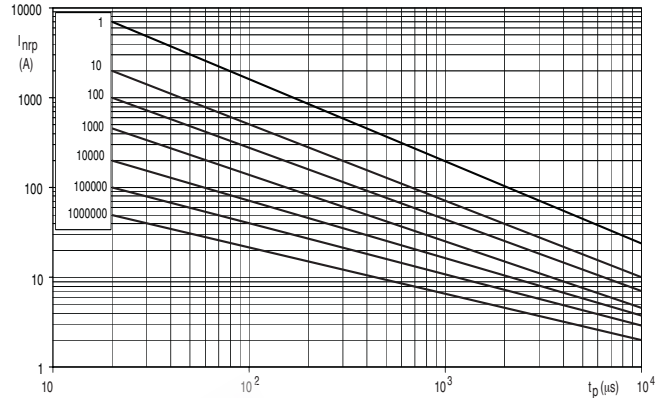

MAXIMUM APPLICABLE TRANSIENT CURRENT AS A FUNCTION OF PULSE DURATION, 320V TO 680V (RMS); 2322 596 series.

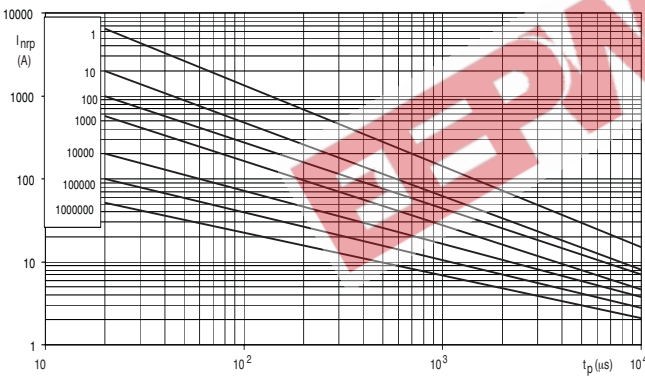

電子產品世界
www.electronicshome.com.cn