



## Technical Data Sheet

# Chip LEDs with Right Angle Lens

### 22-21SURC/S530-XX/TR8

#### Features

- Package in 8mm tape on 7" diameter reel.
- Compatible with automatic placement equipment.
- Compatible with infrared and vapor phase reflow solder process.
- Mono-color type.
- Pb-free.
- The product itself will remain within RoHS complaint Version.



#### Descriptions

- The 22-21 SMD Taping is much smaller than lead frame type components, thus enable smaller board size, higher packing density, reduced storage space and finally smaller equipment to be obtained.
- Besides, lightweight makes them ideal for miniature applications. etc.

#### Applications

- Automotive: backlighting in dashboard and switch.
- Telecommunication: indicator and backlighting in telephone and fax.
- Flat backlight for LCD, switch and symbol.
- General use.

#### Device Selection Guide

Part No.	Chip		Lens Color
	Material	Emitted Color	
22-21SURC/S530-XX/TR8	AlGaInP	Brilliant Red	Water Clear

**22-21SURC/S530-XX/TR8**

**Package Outline Dimensions**

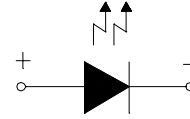
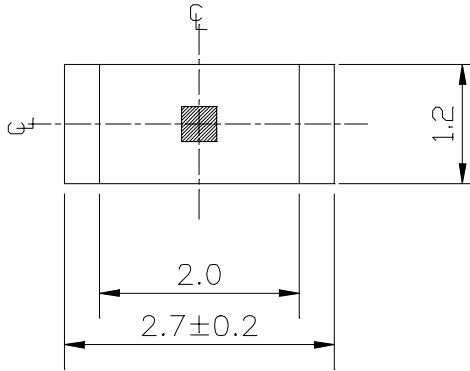

Polarity

For Reflow Soldering (propose)

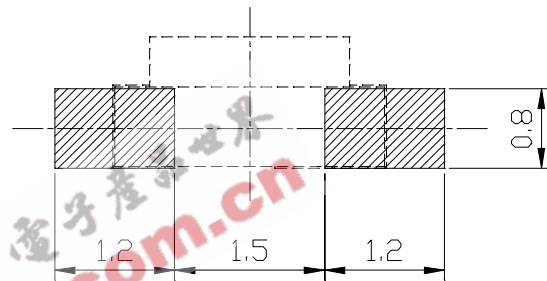
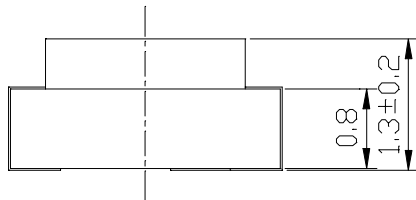

Right-angle mounting

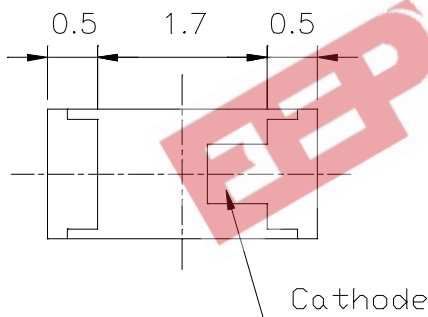

**Note:** The tolerances unless mentioned is  $\pm 0.1\text{mm}$  ,Unit = mm

**22-21SURC/S530-XX/TR8**
**Absolute Maximum Ratings (Ta=25°C)**

Parameter	Symbol	Rating	Unit
Reverse Voltage	V <sub>R</sub>	5	V
Forward Current	I <sub>F</sub>	25	mA
Operating Temperature	T <sub>opr</sub>	-40 ~ +85	°C
Storage Temperature	T <sub>stg</sub>	-40~ +90	°C
Electrostatic Discharge(HBM)	ESD	2000	V
Power Dissipation	P <sub>d</sub>	60	mW
Peak Forward Current (Duty 1/10 @1KHz)	I <sub>F(PEAK)</sub>	60	mA
Soldering Temperature	T <sub>sol</sub>	Reflow Soldering : 260 °C for 10 sec. Hand Soldering : 350 °C for 3 sec.	

**Electro-Optical Characteristics (Ta=25°C)**

Parameter	Symbol	*Chip Rank	Min.	Typ.	Max.	Unit	Condition
Luminous Intensity	I <sub>v</sub>	A2	15	39	-----	mcd	I <sub>F</sub> =20mA
		A3	36	56	-----		
		A4	49	76	-----		
		A5	60	94	-----		
		A6	72	114	-----		
Viewing Angle	2θ 1/2	-----	-----	130	-----	deg	I <sub>F</sub> =20mA
Peak Wavelength	λ <sub>p</sub>	-----	-----	632	-----	nm	I <sub>F</sub> =20mA
Dominant Wavelength	λ <sub>d</sub>	-----	-----	624	-----	nm	I <sub>F</sub> =20mA
Spectrum Radiation Bandwidth	Δλ	-----	-----	20	-----	nm	I <sub>F</sub> =20mA
Forward Voltage	V <sub>F</sub>	-----	1.7	2.0	2.4	V	I <sub>F</sub> =20mA
Reverse Current	I <sub>R</sub>	-----	-----	-----	10	μA	V <sub>R</sub> =5V

**\*22-21SURC/S530-XX/TR8**

**Typical Electro-Optical Characteristics Curves**

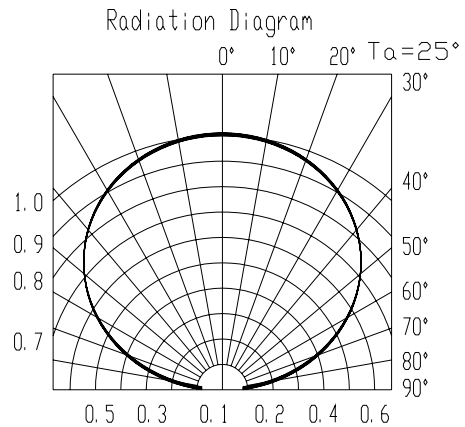
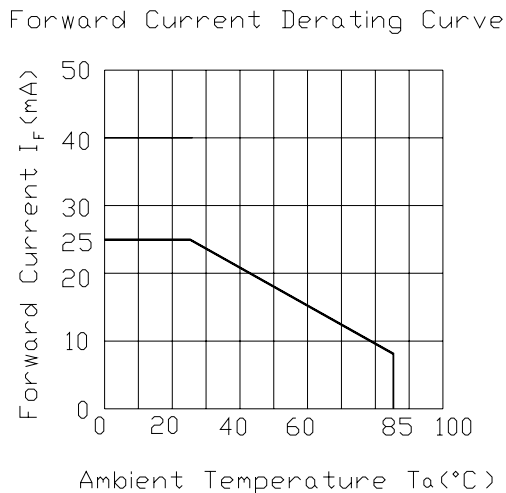
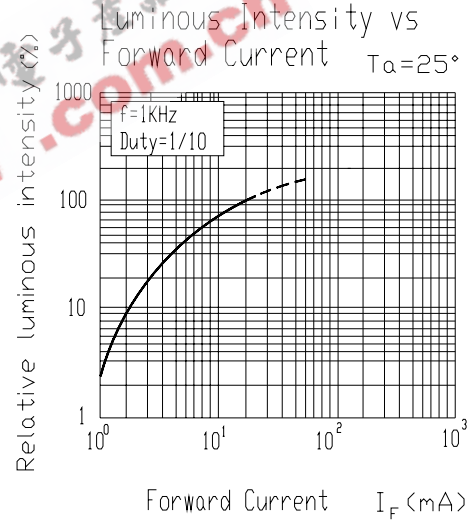
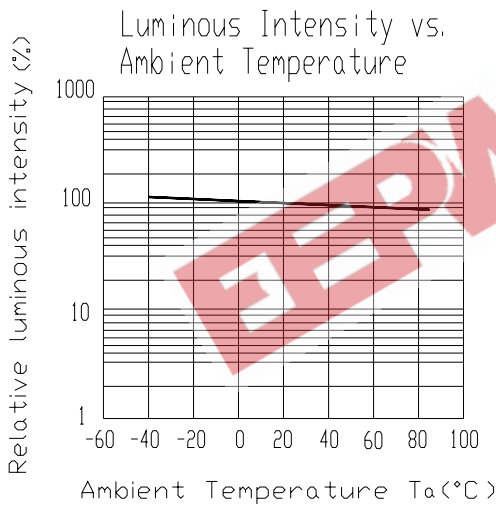
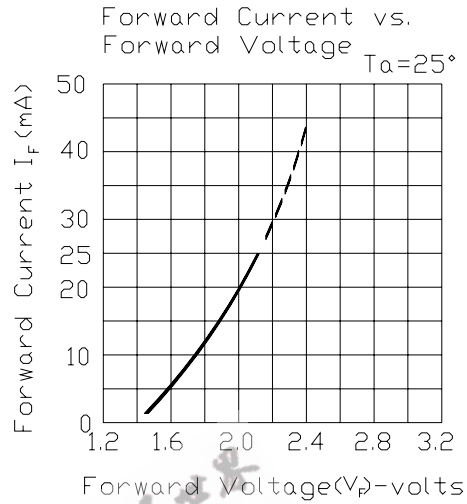
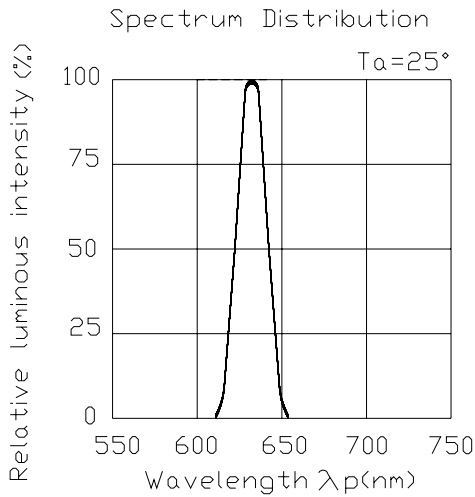

**Label explanation**

**CAT: Luminous Intensity Rank**

**HUE: Dom. Wavelength Rank**

**REF: Forward Voltage Rank**

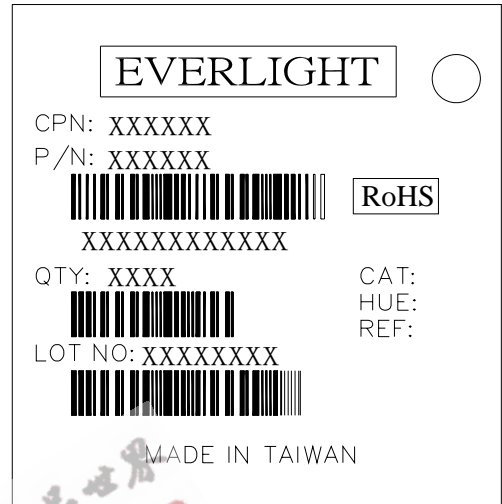

**Reel Dimensions**

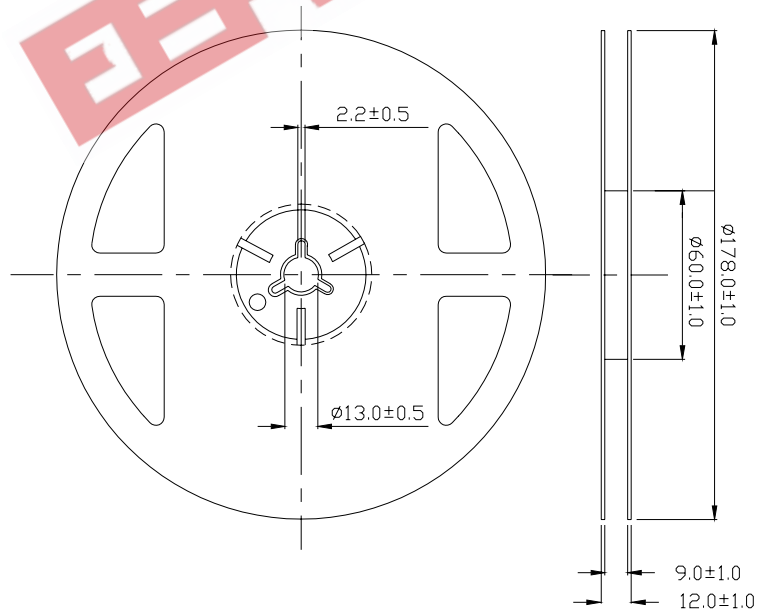

**Note:** The tolerances unless mentioned is  $\pm 0.1\text{mm}$  , Unit = mm

**Carrier Tape Dimensions: Loaded quantity 2000 PCS per reel**

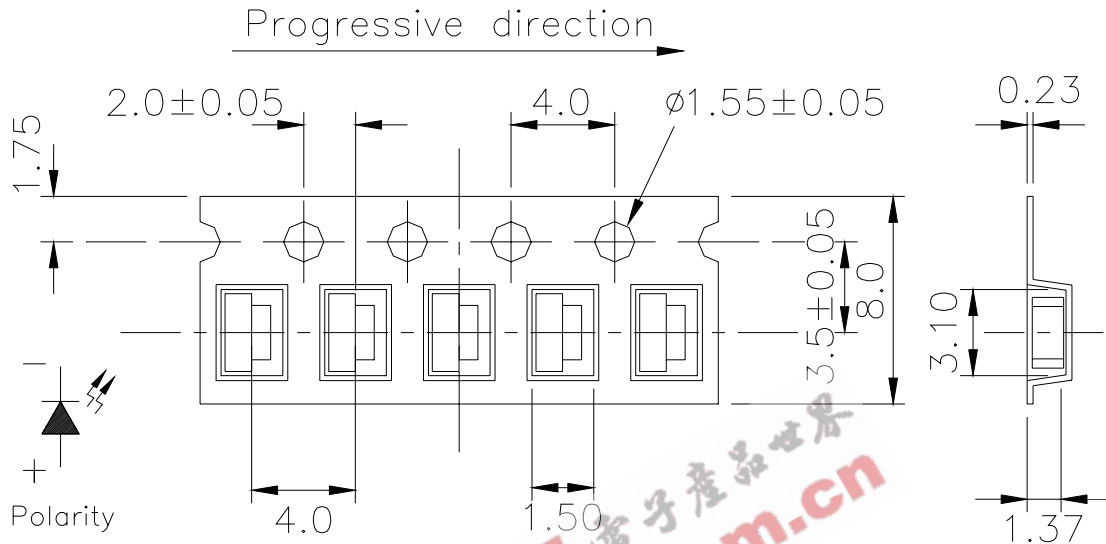

**Note:** Tolerances Unless Dimension  $\pm 0.1\text{mm}$ , Unit = mm

**Moisture Resistant Packaging**

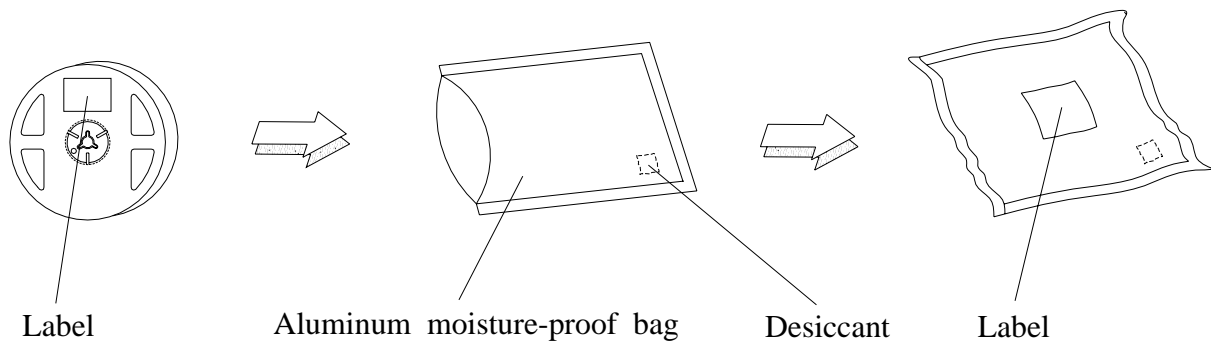

**Reliability Test Items And Conditions**

The reliability of products shall be satisfied with items listed below.

Confidence level : 90%

LTPD : 10%

No.	Items	Test Condition	Test Hours/Cycles	Sample Size	Ac/Re
1	Reflow Soldering	Temp. : 240°C ±5°C 5 sec.	6 Min.	22 Pcs.	0/1
2	Temperature Cycle	H : +100°C 15min ∫ 5 min L : -40°C 15min	300 Cycles	22 PCS.	0/1
3	Thermal Shock	H : +100°C 5min ∫ 10 sec L : -10°C 5min	300 Cycles	22 PCS.	0/1
4	High Temperature Storage	Temp. : 100°C	1000 Hrs.	22 PCS.	0/1
5	Low Temperature Storage	Temp. : -55°C	1000 Hrs.	22 PCS.	0/1
6	DC Operating Life	IF = 20 mA	1000 Hrs.	22 PCS.	0/1
7	High Temperature / High Humidity	85°C/RH85%	1000 Hrs.	22 PCS.	0/1

**Precautions For Use**

1. Over-current-proof

Customer must apply resistors for protection , otherwise slight voltage shift will cause big current change ( Burn out will happen ).

2. Storage

- 2.1 Do not open moisture proof bag before the products are ready to use.
- 2.2 Before opening the package, the LEDs should be kept at 30°C or less and 90%RH or less.
- 2.3 The LEDs should be used within a year.
- 2.4 After opening the package, the LEDs should be kept at 30°C or less and 60%RH or less.
- 2.5 The LEDs should be used within 168 hours (7 days) after opening the package.
- 2.6 If the moisture absorbent material (silica gel) has faded away or the LEDs have exceeded the storage time, baking treatment should be performed using the following conditions.  
Baking treatment : 60±5°C for 24 hours.

3. Soldering Condition

3.1 Lead solder temperature profile

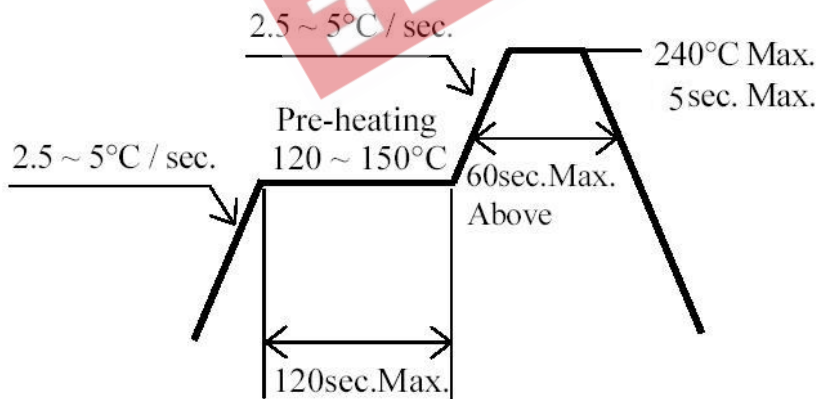

- 3.2 Reflow soldering should not be done more than two times.
- 3.3 When soldering, do not put stress on the LEDs during heating.
- 3.4 After soldering, do not warp the circuit board.



**22-21SURC/S530-XX/TR8****4.Soldering Iron**

Each terminal is to go to the tip of soldering iron temperature less than 280°C for 3 seconds within once in less than the soldering iron capacity 25W. Leave two seconds and more intervals, and do soldering of each terminal. Be careful because the damage of the product is often started at the time of the hand solder.

**5.Repairing**

Repair should not be done after the LEDs have been soldered. When repairing is unavoidable, a double-head soldering iron should be used (as below figure). It should be confirmed beforehand whether the characteristics of the LEDs will or will not be damaged by repairing.

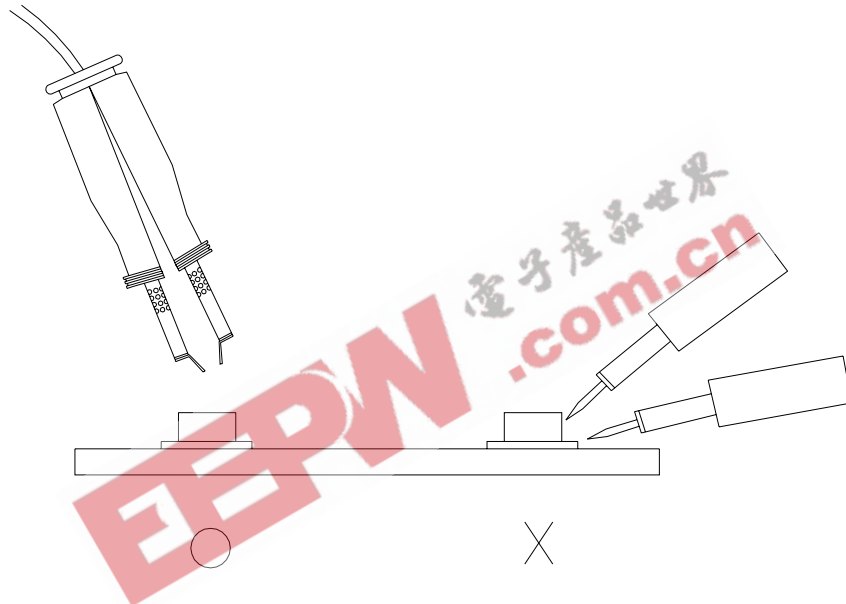

**EVERLIGHT ELECTRONICS CO., LTD.**  
Office: No 25, Lane 76, Sec 3, Chung Yang Rd,  
Tucheng, Taipei 236, Taiwan, R.O.C

Tel: 886-2-2267-2000, 2267-9936  
Fax: 886-2267-6244, 2267-6189, 2267-6306  
<http://www.everlight.com>