

Technical Data Sheet

3.0mm Round Type LED Lamps

A694B/2SUR/S530-A3

■ Features :

- Low power consumption
- High efficiency and low cost
- Good control and free combinations
on the colors of LED lamps
- Good lock and easy to assembly
- Stackable and easy to assembly
- Stackable vertically and easy to assembly
- Versatile mounting on P.C board or panel
- Stackable horizontally and easy to assembly
- Pb free

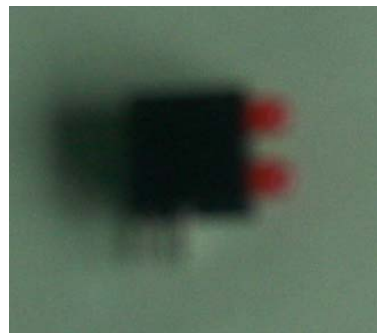

■ Descriptions :

- ARRAY=Plastic Holder+Combinations of Lamps
- The array will easily mount the applicable lamps on any panel up to

■ Applications :

- 1.Used as indicators of indicating the Degree, Functions, Positions etc, in electronic instruments.

EEPN 电子產品世界 .com.cn

| PART NO. | Chip | | Lens Color |
|--------------------|----------|---------------|--------------|
| | Material | Emitted Color | |
| 234-10SURD/S530-A3 | AlGaInP | Hyper Red | Red Diffused |

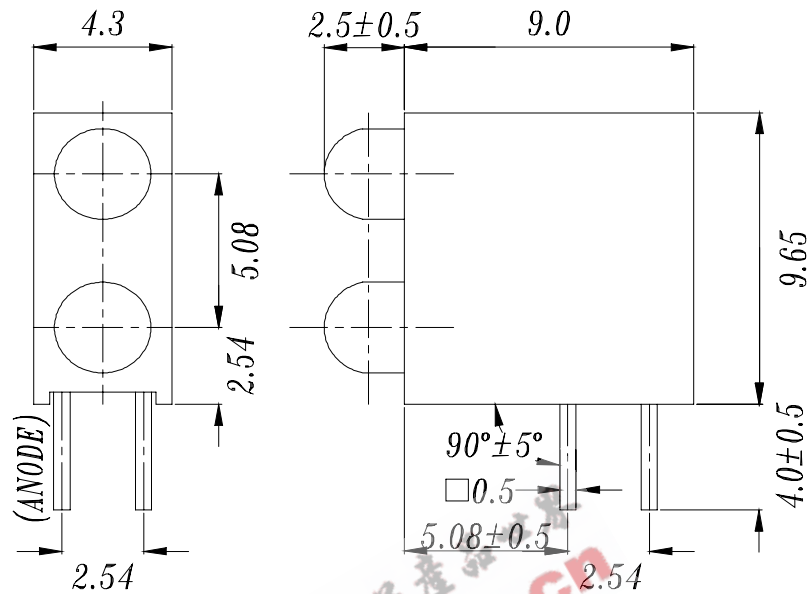
Technical Data Sheet
3.0mm Round Type LED Lamps
A694B/2SUR/S530-A3
Package Dimensions

- Notes:** 1.All dimensions are in millimeters, tolerance is 0.25mm except being specified
2.Lead spacing is measured where the lead emerge from the package

Absolute Maximum Ratings at Ta = 25°C

| Parameter | Symbol | Rating | Unit |
|-------------------------|----------|-------------|------|
| Forward Current | IF | 25 | mA |
| Operating Temperature | Topr | -40 to +85 | °C |
| Storage Temperature | Tstg | -40 to +100 | °C |
| Soldering Temperature | Tsol | 260 ± 5 | °C |
| Electrostatic Discharge | ESD | 2000 | V |
| Power Dissipation | Pd | 60 | mW |
| Peak Forward Current | IF(Peak) | 160 | mA |
| Reverse Voltage | VR | 5 | V |

Note: *1:IFP Conditions --Pulse Width ≤ 1msec and Duty ≤ 1/10.

*2:Soldering time ≤ 5 seconds.



EVERLIGHT ELECTRONICS CO.,LTD.

Technical Data Sheet

3.0mm Round Type LED Lamps

A694B/2SUR/S530-A3

Electro-Optical Characteristics (Ta=25°C)

| Parameter | Symbol | Condition | Min. | Typ. | Max. | Unit |
|------------------------------|----------------|------------------------|------|------|------|------|
| Forward Voltage | V _F | I _F = 20 mA | / | 2.0 | 2.4 | V |
| Reverse Current | I _R | V _R = 5 V | / | / | 10 | μA |
| Luminous Intensity | I _v | I _F = 20 mA | 10 | 25 | / | mcd |
| Viewing Angle | 2θ 1/2 | I _F = 20 mA | / | 60 | / | deg |
| Peak Wavelength | λ _p | I _F = 20 mA | / | 632 | / | nm |
| Dominant Wavelength | λ _d | I _F = 20 mA | / | 624 | / | nm |
| Spectrum Radiation Bandwidth | Δλ | I _F = 20 mA | / | 20 | / | nm |

Technical Data Sheet

3.0mm Round Type LED Lamps

A694B/2SUR/S530-A3

■ Typical Electro-Optical Characteristic Curves:

(SUR)

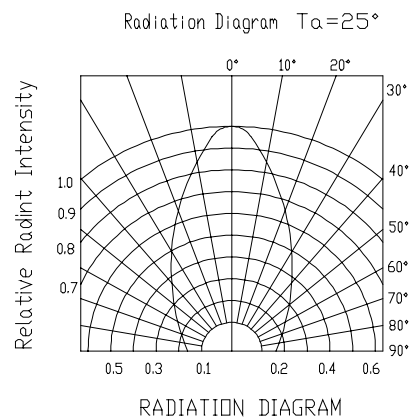
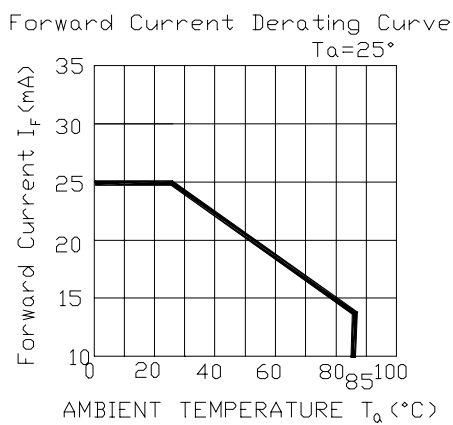
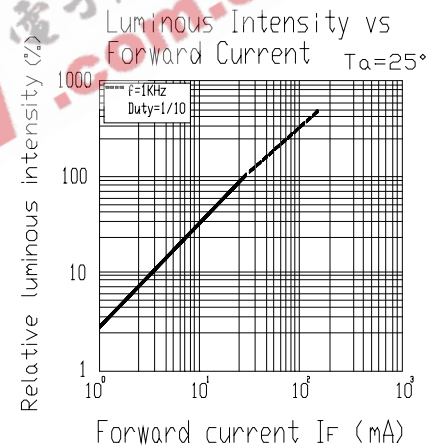
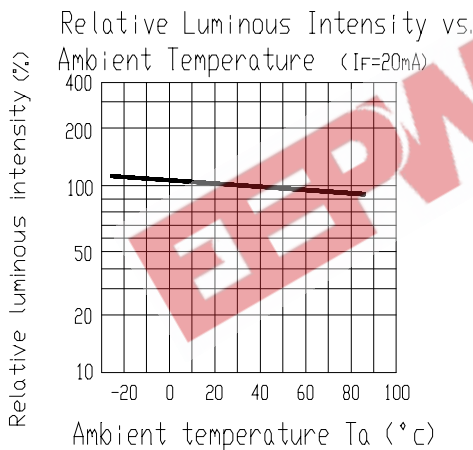
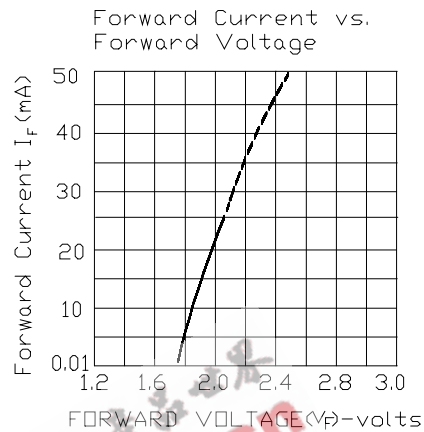
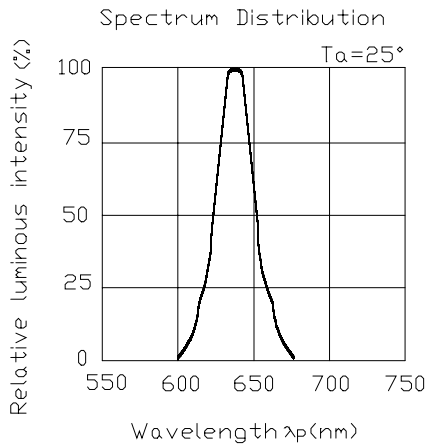



Technical Data Sheet

3.0mm Round Type LED Lamps

A694B/2SUR/S530-A3

■ Reliability test items and conditions:

| NO | Item | Test Conditions | Test Hours/Cycle | Sample Size | Ac/Re |
|----|----------------------------------|--|------------------|-------------|-------|
| 1 | Solder Heat | TEMP : 260°C ± 5 °C | 10 SEC | 76 PCS | 0/1 |
| 2 | Temperature Cycle | H : +100°C 15min ∫ 5 min L : -40°C 15min | 300 CYCLES | 76 PCS | 0/1 |
| 3 | Thermal Shock | H : +100°C 5min ∫ 10 sec L : -10°C 5min | 300 CYCLES | 76 PCS | 0/1 |
| 4 | High Temperature Storage | TEMP : 100°C | 1000 HRS | 76 PCS | 0/1 |
| 5 | Low Temperature Storage | TEMP : -40°C | 1000 HRS | 76 PCS | 0/1 |
| 6 | DC Operating Life | TEMP : 25°C If = 20mA | 1000 HRS | 76 PCS | 0/1 |
| 7 | High Temperature / High Humidity | 85°C / 85% RH | 1000 HRS | 76 PCS | 0/1 |



Technical Data Sheet

3.0mm Round Type LED Lamps

A694B/2SUR/S530-A3

Packing Quantity Specification

- 1. 270PCS/1Plate , 4Plates/1Box
- 2. 10Boxes/1Carton

Label Form Specification



CPN: Customer's Production Number
P/N : Production Number
QTY: Packing Quantity
CAT: Ranks
HUE: Peak Wavelength
REF: Reference
LOT No: Lot Number
MADE IN TAIWAN: Production Place

MADE IN TAIWAN

Notes

1. Above specification may be changed without notice. EVERLIGHT will reserve authority on material change for above specification.
2. When using this product, please observe the absolute maximum ratings and the instructions for using outlined in these specification sheets. EVERLIGHT assumes no responsibility for any damage resulting from use of the product which does not comply with the absolute maximum ratings and the instructions included in these specification sheets.
3. These specification sheets include materials protected under copyright of EVERLIGHT corporation. Please don't reproduce or cause anyone to reproduce them without EVERLIGHT's consent.

| | |
|---|--|
| EVERLIGHT ELECTRONICS CO., LTD. | Tel: (886-2-2267-2000, 2267-9936 |
| Office: No 25, Lane 76, Sec 3, Chung Yang Rd, | Fax: 886-2267-6244, 2267-6189, 2267-6306 |
| Tucheng, Taipei 236, Taiwan, R.O.C | http://www.everlight.com |