

# International IOR Rectifier

## 40L15CTSPbF 40L15CT-1PbF

SCHOTTKY RECTIFIER

2 x 20 Amps

$I_{F(AV)} = 40\text{Amp}$   
 $V_R = 15\text{V}$

### Major Ratings and Characteristics

Characteristics	Values	Units
$I_{F(AV)}$ Rectangular waveform	40	A
$V_{RRM}$	15	V
$I_{FSM}$ @tp=5 $\mu$ s sine	700	A
$V_F$ @19Apk, $T_J=125^\circ\text{C}$ (per leg, Typical)	0.25	V
$T_J$	-55 to 125	$^\circ\text{C}$

### Description/ Features

The center tap Schottky rectifier module has been optimized for ultra low forward voltage drop specifically for the OR-ing of parallel power supplies. The proprietary barrier technology allows for reliable operation up to 125  $^\circ\text{C}$  junction temperature. Typical applications are in parallel switching power supplies, converters, reverse battery protection, and redundant power subsystems.

- 125 $^\circ\text{C}$   $T_J$  operation ( $V_R < 5\text{V}$ )
- Center tap module
- Optimized for OR-ing applications
- Ultra low forward voltage drop
- High frequency operation
- Guard ring for enhanced ruggedness and long term reliability
- High purity, high temperature epoxy encapsulation for enhanced mechanical strength and moisture resistance
- Lead-Free ("PbF" suffix)

### Case Styles

40L15CTSPbF

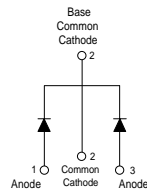

**D<sup>2</sup>PAK**

40L15CT-1PbF

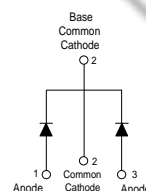

**TO-262**

## Voltage Ratings

Part number	40L15CTSPbF, 40L15CT-1PbF	
$V_R$ Max. DC Reverse Voltage (V) @ $T_J = 100^\circ\text{C}$	15	
$V_{RWM}$ Max. Working Peak Reverse Voltage (V) @ $T_J = 100^\circ\text{C}$	15	

## Absolute Maximum Ratings

Parameters	Values	Units	Conditions
$I_{F(AV)}$ Max. Average Forward Current (Per Leg) * See Fig. 5 (Per Device)	20	A	50% duty cycle @ $T_C = 85^\circ\text{C}$ , rectangular wave form
	40		
$I_{FSM}$ Max. Peak One Cycle Non-Repetitive Surge Current (Per Leg) * See Fig. 7	700	A	5 $\mu\text{s}$ Sine or 3 $\mu\text{s}$ Rect. pulse 10ms Sine or 6ms Rect. pulse Following any rated load condition and with rated $V_{RRM}$ applied
	330		
$E_{AS}$ Non-Repetitive Avalanche Energy (Per Leg)	10	mJ	$T_J = 25^\circ\text{C}$ , $I_{AS} = 2$ Amps, $L = 6$ mH
$I_{AR}$ Repetitive Avalanche Current (Per Leg)	2	A	Current decaying linearly to zero in 1 $\mu\text{sec}$ Frequency limited by $T_{Jmax}$ . $V_A = 1.5 \times V_R$ typical

## Electrical Specifications

Parameters	Values		Units	Conditions	
	Typ.	Max.			
$V_{FM}$ Forward Voltage Drop (Per Leg) * See Fig. 1 (1)	-	0.41	V	@ 19A	$T_J = 25^\circ\text{C}$
	-	0.52	V	@ 40A	
	0.25	0.33	V	@ 19A	$T_J = 125^\circ\text{C}$
	0.37	0.50	V	@ 40A	
$I_{RM}$ Reverse Leakage Current (Per Leg) * See Fig. 2 (1)	-	10	mA	$T_J = 25^\circ\text{C}$	$V_R = \text{rated } V_R$
	-	600	mA	$T_J = 100^\circ\text{C}$	
$V_{F(TO)}$ Threshold Voltage	0.182		V	$T_J = T_J \text{ max.}$	
$r_t$ Forward Slope Resistance	7.6		m $\Omega$		
$C_T$ Max. Junction Capacitance (Per Leg)	-	2000	pF	$V_R = 5V_{DC}$ (test signal range 100Khz to 1Mhz) $25^\circ\text{C}$	
$L_S$ Typical Series Inductance (Per Leg)	8	-	nH	Measured lead to lead 5mm from package body	
dv/dt Max. Voltage Rate of Change	10000		V/ $\mu\text{s}$	(Rated $V_R$ )	

(1) Pulse Width < 300 $\mu\text{s}$ , Duty Cycle <2%

## Thermal-Mechanical Specifications

Parameters	Values	Units	Conditions
$T_J$ Max. Junction Temperature Range	-55 to 125	$^\circ\text{C}$	
$T_{stg}$ Max. Storage Temperature Range	-55 to 150	$^\circ\text{C}$	
$R_{thJC}$ Max. Thermal Resistance Junction to Case (Per Leg)	1.5	$^\circ\text{C}/\text{W}$	DC operation * See Fig. 4
$R_{thCS}$ Typical Thermal Resistance Case to Heatsink	0.50	$^\circ\text{C}/\text{W}$	Mounting surface, smooth and greased Only for TO-220
$R_{thJA}$ Max. Thermal Resistance Junction to Ambient	40	$^\circ\text{C}/\text{W}$	DC operation For D <sup>2</sup> Pak and TO-262
wt Approximate Weight	2 (0.07)	g (oz.)	
T Mounting Torque	Min.	6 (5)	Kg-cm (lbf-in)
	Max.	12 (10)	
Marking Device	40L15CTS		Case style D <sup>2</sup> Pak
	40L15CT-1		Case style TO-262

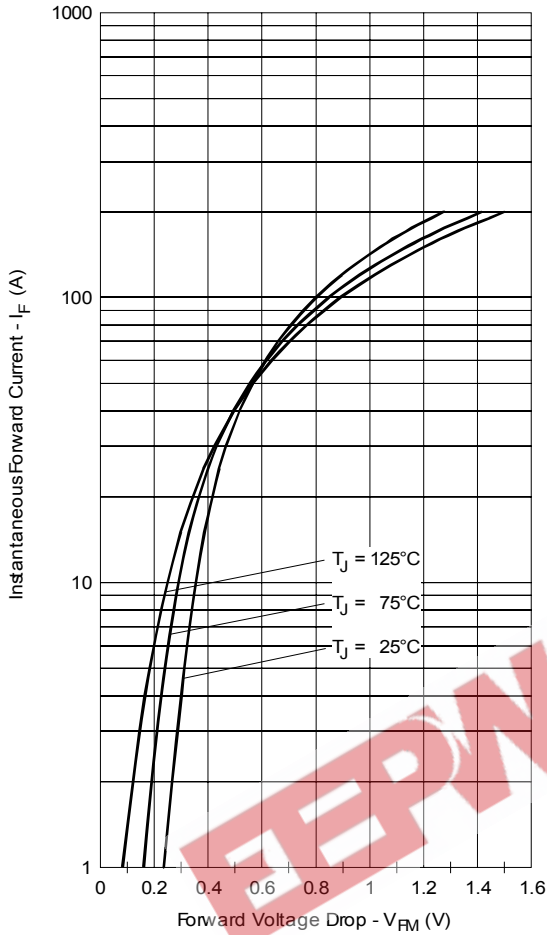

Fig. 1 - Maximum Forward Voltage Drop Characteristics

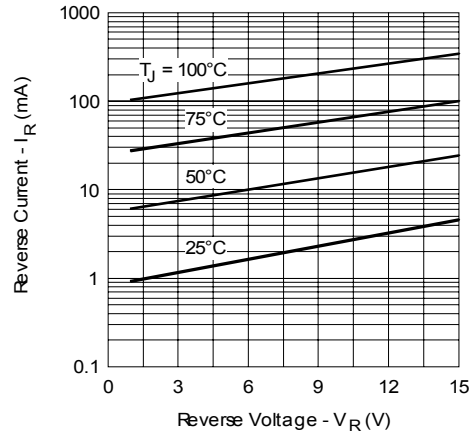

Fig. 2 - Typical Values of Reverse Current Vs. Reverse Voltage

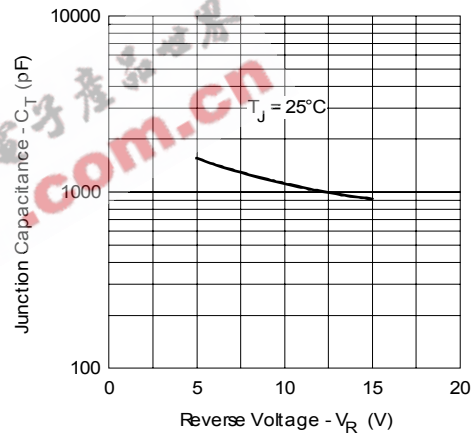

Fig. 3 - Typical Junction Capacitance Vs. Reverse Voltage

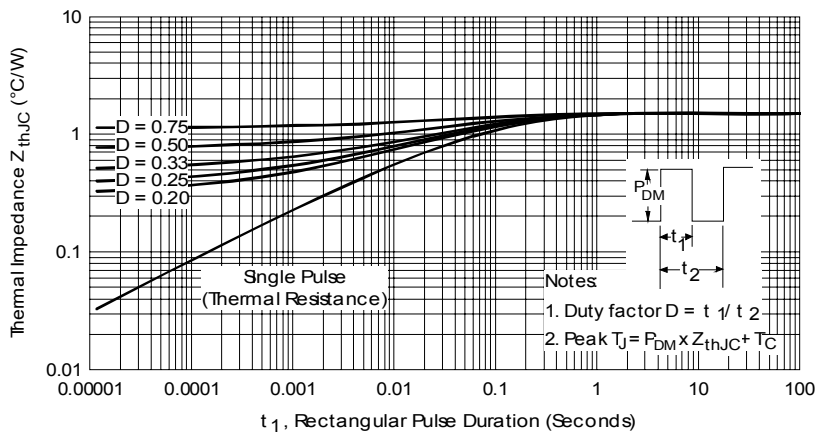

Fig. 4 - Maximum Thermal Impedance  $Z_{thJC}$  Characteristics

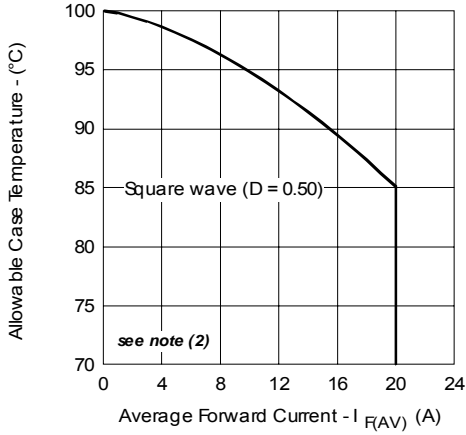

Fig. 5 - Maximum Allowable Case Temperature Vs. Average Forward Current

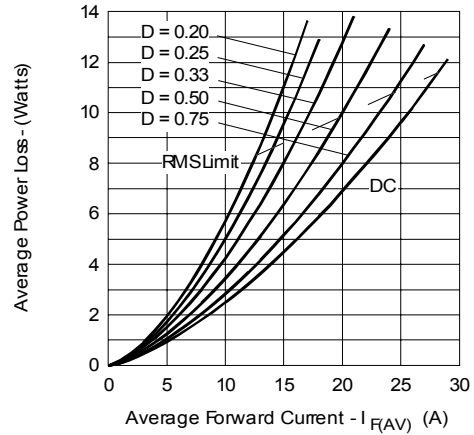

Fig. 6 - Forward Power Loss Characteristics

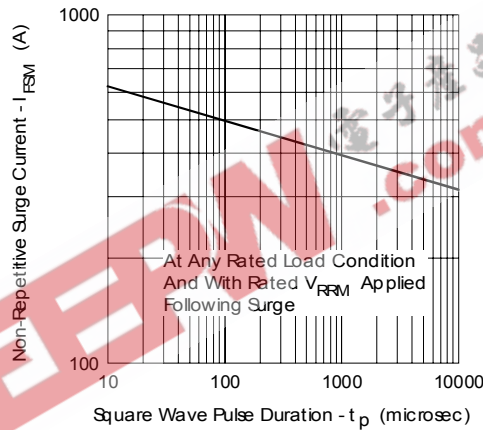

Fig. 7 - Maximum Non-Repetitive Surge Current

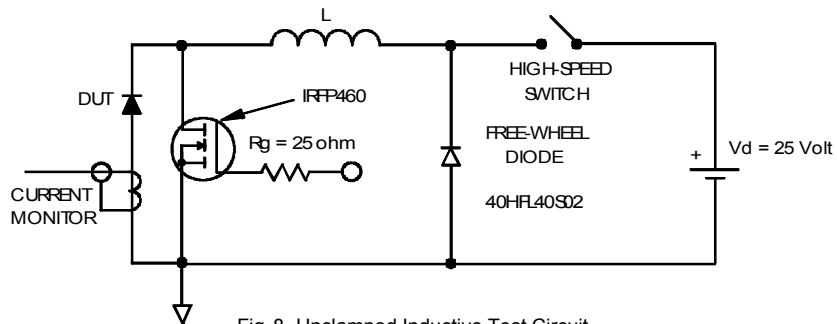

Fig. 8 - Unclamped Inductive Test Circuit

(2) Formula used:  $T_c = T_j - (Pd + Pd_{REV}) \times R_{thJC}$ ;

$Pd$  = Forward Power Loss =  $I_{F(AV)} \times V_{FM} @ (I_{F(AV)} / D)$  (see Fig. 6);

$Pd_{REV}$  = Inverse Power Loss =  $V_{R1} \times I_{R1} (1 - D)$ ;  $I_{R1} @ V_{R1} = 80\%$  rated  $V_R$

Outlines Table

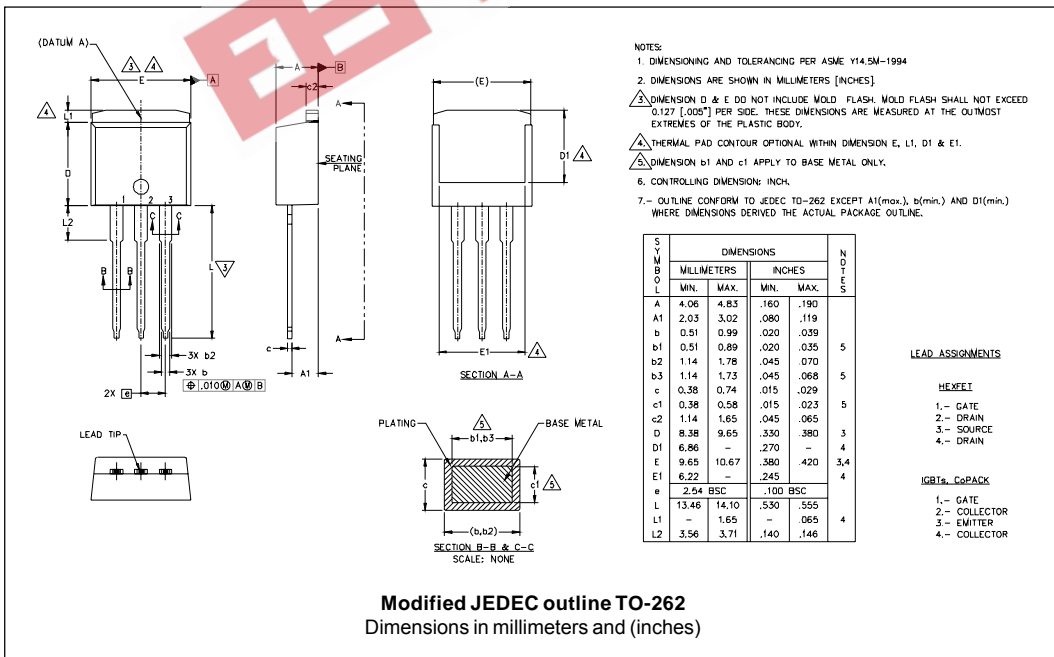
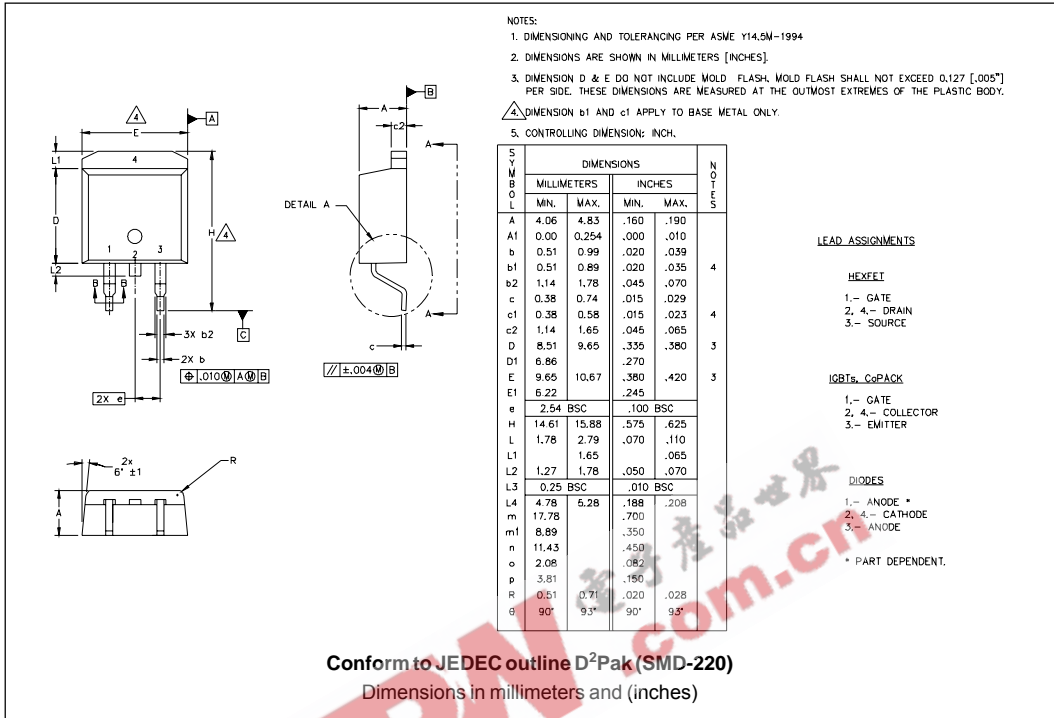

### Part Marking Information

**D<sup>2</sup>PAK**

EXAMPLE: THIS IS A 40L15CTS  
 LOT CODE 8024  
 ASSEMBLED ON WW 02, 2000

Note: "P" in assembly line position indicates "Lead-Free"

INTERNATIONAL RECTIFIER LOGO

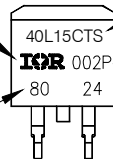

ASSEMBLY LOT CODE

PART NUMBER

40L15CTS

IRF 002P

DATE CODE

YEAR 0 = 2000

WEEK 02

P = LEAD-FREE

**TO-262**

EXAMPLE: THIS IS A 40L15CT-1  
 LOT CODE 1789  
 ASSEMBLED ON WW 19, 2002

Note: "P" in assembly line position indicates "Lead-Free"

INTERNATIONAL RECTIFIER LOGO

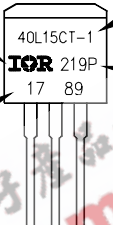

ASSEMBLY LOT CODE

PART NUMBER

40L15CT-1

IRF 219P

DATE CODE

YEAR 2 = 2002

WEEK 19

P = LEAD-FREE

### Tape & Reel Information

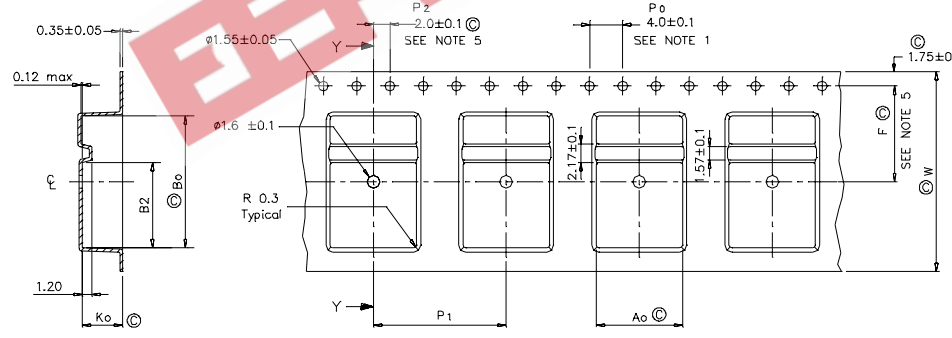

SECTION Y-Y

Ao	10.50	+/-	0.1
Bo	15.80	+/-	0.1
B2	10.25	+/-	0.1
Ko	4.90	+/-	0.1
F	11.50	+/-	0.1
P1	16.00	+/-	0.1
W	24.00	+/-	0.3

NOTES:

- 1.0 10 SPROCKET HOLE PITH CUMULATIVE TOLERANCE ±0.2
- 2.0 CAMBER NOT TO EXCEED 1mm In 100mm
- 3.0 MATERIAL: CONDUCTIVE BLACK STYRENIC ALLOY
- 4.0 Ko MEASURED FROM A PLANE ON THE INSIDE BOTTOM OF THE POCKET TO THE TOP SURFACE OF THE CARRIER
- 5.0 MEASURED FROM CENTRELINE OF SPROCKET HOLE TO CENTRELINE OF POCKET
- 6.0 VENDOR: (OPTIONAL)
- 7.0 MUST ALSO MEET REQUIREMENTS OF EIA STANDAR #EIA-481A TAPING OF SURFACE MOUNT COMPONENTS FOR AUTOMATIC PLACEMENT
- 8.0 SURFACE RESISTIVITY OF MOLDED MATL. MUST MEASURE LESS OR EQUAL TO 10<sup>6</sup> OHMS PER SQUARE. MEASURED IN ACCORDANCE TO PROCEDURE GIVEN IN ASTM D-257 & ASTM D-991
- 9.0 TOTAL LENGTH PER REEL MUST BE 45 METERS
- 10.0 © CRITICAL

Dimensions in millimeters and (inches)

Ordering Information Table

Device Code	40	L	15	C	T	S	TRL	PbF
	①	②	③	④	⑤	⑥	⑦	⑧
<b>1</b>	-	Current Rating (40A)						
<b>2</b>	-	L = Schottky L Series						
<b>3</b>	-	Voltage Rating (15V)						
<b>4</b>	-	C = Common Cathode						
<b>5</b>	-	T = TO-220						
<b>6</b>	-	• S = D <sup>2</sup> Pak						
		• -1= TO-262						
<b>7</b>	-	• none = Tube (50 pieces)						
		• TRL = Tape & Reel (Left Oriented - for D <sup>2</sup> Pak only)						
		• TRR = Tape & Reel (Right Oriented - for D <sup>2</sup> Pak only)						
<b>8</b>	-	• none = Standard Production						
		• PbF = Lead-Free						

Data and specifications subject to change without notice.  
 This product has been designed and qualified for Industrial Level and Lead-Free.  
 Qualification Standards can be found on IR's Web site.