

# International **IR** Rectifier

## 40L40CWPbF 40L45CWPbF

SCHOTTKY RECTIFIER

2 x 20 Amps

$I_{F(AV)} = 40\text{Amp}$   
 $V_R = 40\text{-}45\text{V}$

### Major Ratings and Characteristics

Characteristics	40L..CW	Units
$I_{F(AV)}$ Rectangular waveform	40	A
$V_{RRM}$	40 - 45	V
$I_{FSM}$ @tp = 5 $\mu$ s sine	1240	A
$V_F$ @20 Apk, $T_J = 125^\circ\text{C}$ (per leg, Typical)	0.42	V
$T_J$	-55 to 150	$^\circ\text{C}$

### Description/ Features

The 40L..CWPbF center tap Schottky rectifier has been optimized for very low forward voltage drop, with moderate leakage. The proprietary barrier technology allows for reliable operation up to 150 $^\circ\text{C}$  junction temperature. Typical applications are in switching power supplies.

- 150 $^\circ\text{C}$   $T_J$  operation
- Center tap TO-247 package
- High purity, high temperature epoxy encapsulation for enhanced mechanical strength and moisture resistance
- Very low forward voltage drop
- High frequency operation
- Guard ring for enhanced ruggedness and long term reliability
- Lead-Free ("PbF" suffix)

### Case Styles



TO-247AC

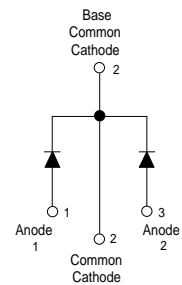

40L40CWPbF, 40L45CWPbF

Bulletin PD-20794 rev.A 11/06



Voltage Ratings

Partnumber	40L40CWPbF	40L45CWPbF
V <sub>R</sub> Max. DC Reverse Voltage (V)	40	45
V <sub>RWM</sub> Max. Working Peak Reverse Voltage (V)		

Absolute Maximum Ratings

Parameters	40L..CW	Units	Conditions
I <sub>F(AV)</sub> Max. Average Forward Current (Per Leg) * See Fig. 5 (Per Device)	20 40	A	50% duty cycle @ T <sub>C</sub> = 122 °C, rectangular wave form
I <sub>FSM</sub> Max. Peak One Cycle Non-Repetitive Surge Current (Per Leg) * See Fig. 7	1240 350	A	5µs Sine or 3µs Rect. pulse 10ms Sine or 6ms Rect. pulse Following any rated load condition and with rated V <sub>RRM</sub> applied
E <sub>AS</sub> Non-Repetitive Avalanche Energy (Per Leg)	20	mJ	T <sub>J</sub> = 25 °C, I <sub>AS</sub> = 3 Amps, L = 4.4 mH
I <sub>AR</sub> Repetitive Avalanche Current (Per Leg)	3	A	Current decaying linearly to zero in 1 µsec Frequency limited by T <sub>Jmax</sub> . V <sub>A</sub> = 1.5 x V <sub>R</sub> typical

Electrical Specifications

Parameters	40L..CW		Units	Conditions	
	Typ.	Max.			
V <sub>FM</sub> Forward Voltage Drop (Per Leg) * See Fig. 1 (1)	0.48	0.53	V	@ 20A	T <sub>J</sub> = 25 °C
	0.61	0.69	V	@ 40A	
	0.42	0.49	V	@ 20A	T <sub>J</sub> = 125 °C
	0.60	0.70	V	@ 40A	
I <sub>RM</sub> Reverse Leakage Current (Per Leg) * See Fig. 2 (1)	-	1.5	mA	T <sub>J</sub> = 25 °C	V <sub>R</sub> = rated V <sub>R</sub>
	20	80	mA	T <sub>J</sub> = 100 °C	
V <sub>F(TO)</sub> Threshold Voltage	0.27		V	T <sub>J</sub> = T <sub>J</sub> max.	
r <sub>t</sub> Forward Slope Resistance	8.72		mΩ		
C <sub>T</sub> Max. Junction Capacitance (Per Leg)	-	1500	pF	V <sub>R</sub> = 5V <sub>DC</sub> (test signal range 100Khz to 1Mhz) 25°C	
L <sub>S</sub> Typical Series Inductance (Per Leg)	7.5	-	nH	Measured lead to lead 5mm from package body	
dv/dt Max. Voltage Rate of Change	10000		V/µs	(Rated V <sub>R</sub> )	

Thermal-Mechanical Specifications

(1) Pulse Width < 300µs, Duty Cycle <2%

Parameters	40L..CW	Units	Conditions
T <sub>J</sub> Max. Junction Temperature Range	-55 to 150	°C	
T <sub>stg</sub> Max. Storage Temperature Range	-55 to 150	°C	
R <sub>thJC</sub> Max. Thermal Resistance Junction to Case (Per Leg)	1.6	°C/W	DC operation * See Fig. 4
R <sub>thJC</sub> Max. Thermal Resistance Junction to Case (Per Package)	0.8	°C/W	DC operation
R <sub>thCS</sub> Typical Thermal Resistance, Case to Heatsink	0.24	°C/W	Mounting surface, smooth and greased
wt Approximate Weight	6 (0.21)	g (oz.)	
T Mounting Torque	Min.	6 (5)	Kg-cm (lbf-in)
	Max.	12 (10)	
Case Style	TO-247AC(TO-3P)	JEDEC	
Marking Device	40L40CW		
	40L45CW		

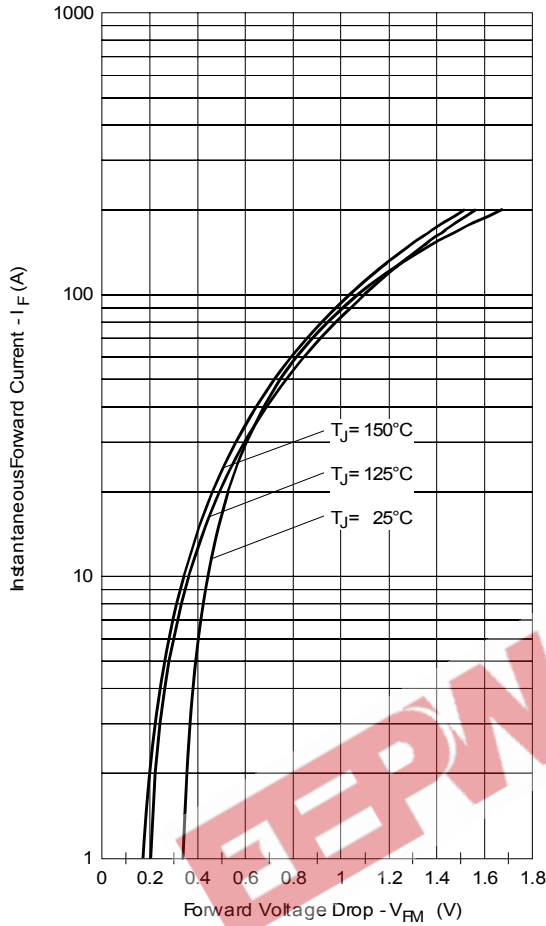

Fig. 1 - Max. Forward Voltage Drop Characteristics (Per Leg)

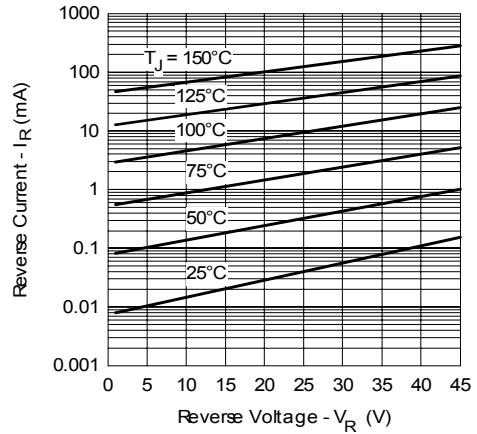

Fig. 2 - Typical Values Of Reverse Current Vs. Reverse Voltage (Per Leg)

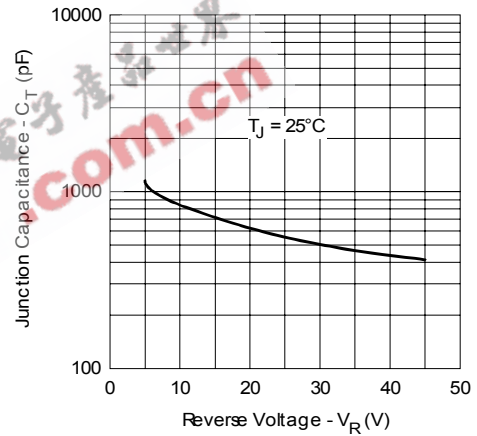

Fig. 3 - Typical Junction Capacitance Vs. Reverse Voltage (Per Leg)

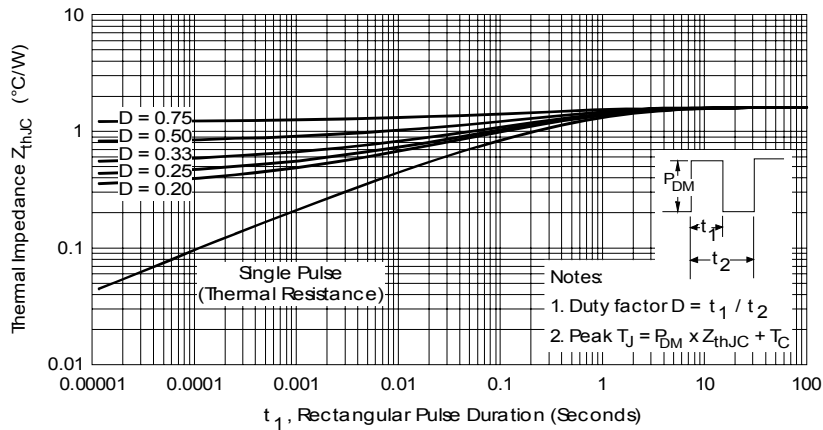

Fig. 4 - Max. Thermal Impedance  $Z_{thJC}$  Characteristics (Per Leg)

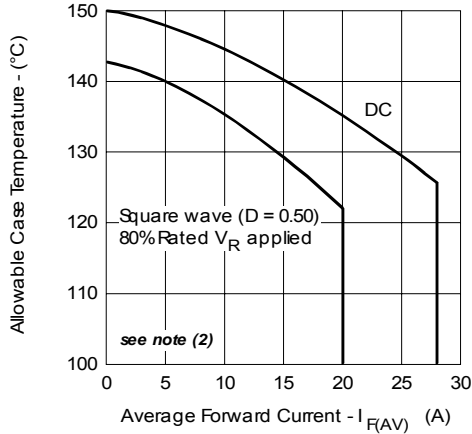

Fig. 5- Max. Allowable Case Temperature Vs. Average Forward Current (Per Leg)

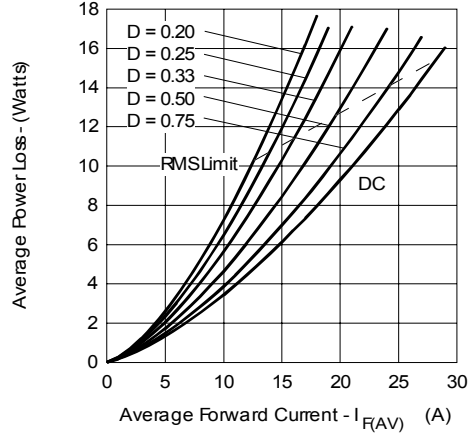

Fig. 6- Forward Power Loss Characteristics (Per Leg)

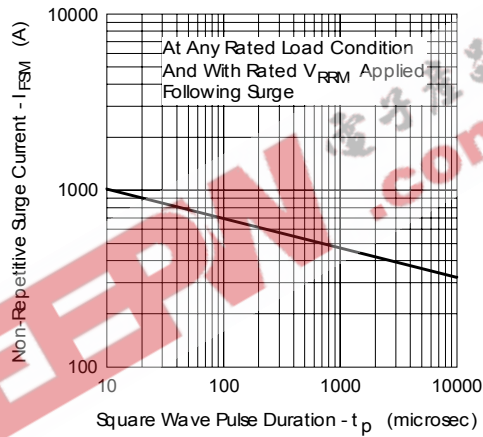

Fig. 7- Max. Non-Repetitive Surge Current (Per Leg)

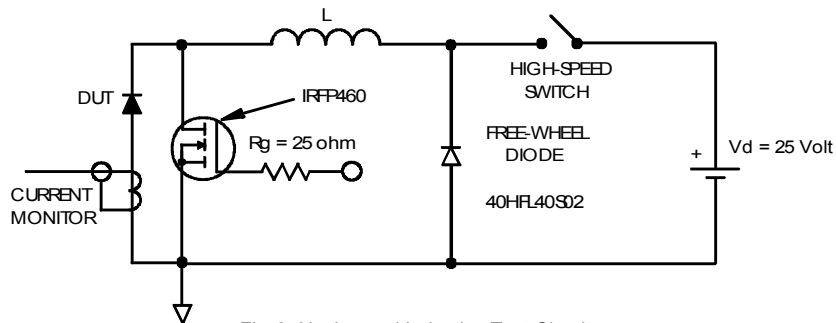

Fig. 8- Unclamped Inductive Test Circuit

(2) Formula used:  $T_c = T_j - (Pd + Pd_{REV}) \times R_{thJC}$ ;

$Pd = \text{Forward Power Loss} = I_{F(AV)} \times V_{FM} @ (I_{F(AV)} / D)$  (see Fig. 6);

$Pd_{REV} = \text{Inverse Power Loss} = V_{R1} \times I_R (1 - D)$ ;  $I_R @ V_{R1} = 80\%$  rated  $V_R$

Outline Table

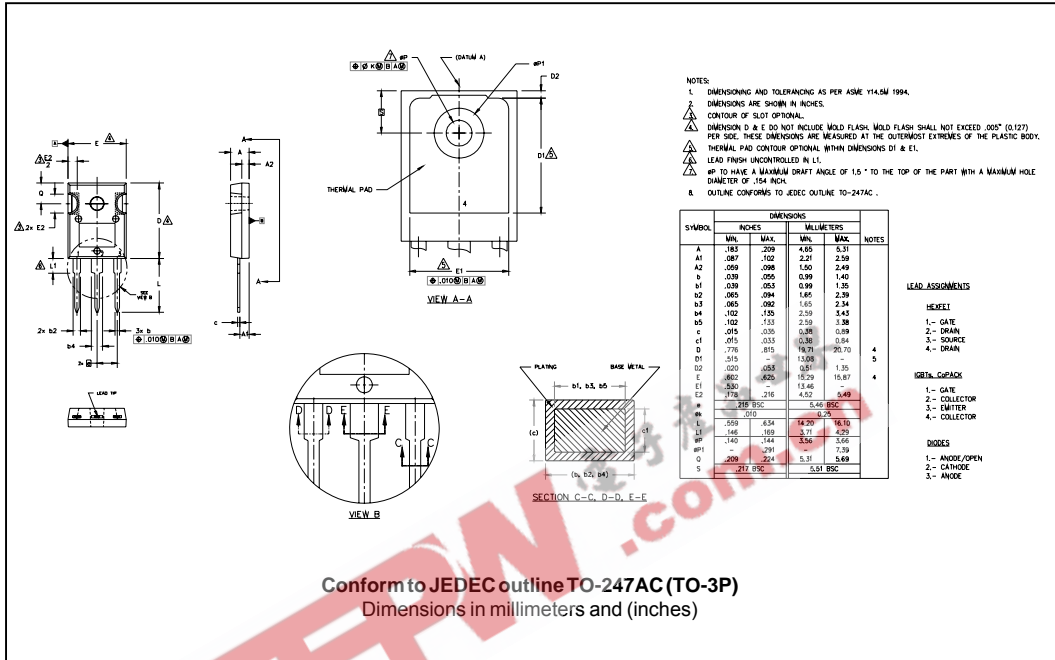

Marking Information

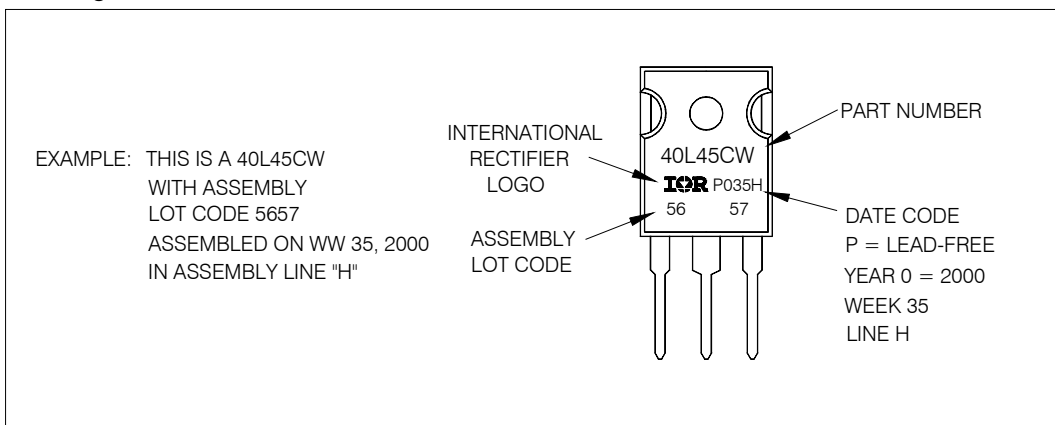

Ordering Information Table

Device Code					
40	L	45	C	W	PbF
①	②	③	④	⑤	⑥

<b>1</b>	-	Current Rating (40 = 40A)	
<b>2</b>	-	Schottky "L" Series	
<b>3</b>	-	Voltage Code	40 = 40V 45 = 45V
<b>4</b>	-	Circuit Configuration	
		C = Common Cathode	
<b>5</b>	-	Package	
		W = TO-247	
<b>6</b>	-	• none = Standard Production	
		• PbF = Lead-Free	

Tube Standard Pack Quantity : 25 pieces

Data and specifications subject to change without notice.  
 This product has been designed and qualified for Industrial Level and Lead-Free.  
 Qualification Standards can be found on IR's Web site.