

International IOR Rectifier

40L15CTSPbF 40L15CT-1PbF

SCHOTTKY RECTIFIER

2 x 20 Amps

$I_{F(AV)} = 40\text{Amp}$
 $V_R = 15\text{V}$

Major Ratings and Characteristics

Characteristics	Values	Units
$I_{F(AV)}$ Rectangular waveform	40	A
V_{RRM}	15	V
I_{FSM} @tp=5 μ s sine	700	A
V_F @19Apk, $T_J=125^\circ\text{C}$ (per leg, Typical)	0.25	V
T_J	-55 to 125	$^\circ\text{C}$

Description/ Features

The center tap Schottky rectifier module has been optimized for ultra low forward voltage drop specifically for the OR-ing of parallel power supplies. The proprietary barrier technology allows for reliable operation up to 125 $^\circ\text{C}$ junction temperature. Typical applications are in parallel switching power supplies, converters, reverse battery protection, and redundant power subsystems.

- 125 $^\circ\text{C}$ T_J operation ($V_R < 5\text{V}$)
- Center tap module
- Optimized for OR-ing applications
- Ultra low forward voltage drop
- High frequency operation
- Guard ring for enhanced ruggedness and long term reliability
- High purity, high temperature epoxy encapsulation for enhanced mechanical strength and moisture resistance
- Lead-Free ("PbF" suffix)

Case Styles

40L15CTSPbF

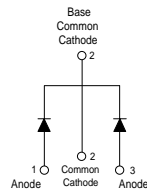

D²PAK

40L15CT-1PbF

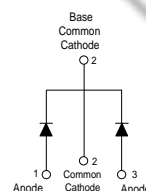

TO-262

Voltage Ratings

Part number	40L15CTSPbF, 40L15CT-1PbF	
V_R Max. DC Reverse Voltage (V) @ $T_J = 100^\circ\text{C}$	15	
V_{RWM} Max. Working Peak Reverse Voltage (V) @ $T_J = 100^\circ\text{C}$	15	

Absolute Maximum Ratings

Parameters	Values	Units	Conditions
$I_{F(AV)}$ Max. Average Forward Current (Per Leg) * See Fig. 5 (Per Device)	20 40	A	50% duty cycle @ $T_C = 85^\circ\text{C}$, rectangular wave form
I_{FSM} Max. Peak One Cycle Non-Repetitive Surge Current (Per Leg) * See Fig. 7	700 330	A	5 μs Sine or 3 μs Rect. pulse 10ms Sine or 6ms Rect. pulse Following any rated load condition and with rated V_{RRM} applied
E_{AS} Non-Repetitive Avalanche Energy (Per Leg)	10	mJ	$T_J = 25^\circ\text{C}$, $I_{AS} = 2$ Amps, $L = 6$ mH
I_{AR} Repetitive Avalanche Current (Per Leg)	2	A	Current decaying linearly to zero in 1 μsec Frequency limited by T_{Jmax} . $V_A = 1.5 \times V_R$ typical

Electrical Specifications

Parameters	Values		Units	Conditions	
	Typ.	Max.			
V_{FM} Forward Voltage Drop (Per Leg) * See Fig. 1 (1)	-	0.41	V	@ 19A	$T_J = 25^\circ\text{C}$
	-	0.52	V	@ 40A	
	0.25	0.33	V	@ 19A	$T_J = 125^\circ\text{C}$
	0.37	0.50	V	@ 40A	
I_{RM} Reverse Leakage Current (Per Leg) * See Fig. 2 (1)	-	10	mA	$T_J = 25^\circ\text{C}$	$V_R = \text{rated } V_R$
	-	600	mA	$T_J = 100^\circ\text{C}$	
$V_{F(TO)}$ Threshold Voltage	0.182		V	$T_J = T_J \text{ max.}$	
r_t Forward Slope Resistance	7.6		m Ω		
C_T Max. Junction Capacitance (Per Leg)	-	2000	pF	$V_R = 5V_{DC}$ (test signal range 100Khz to 1Mhz) 25°C	
L_S Typical Series Inductance (Per Leg)	8	-	nH	Measured lead to lead 5mm from package body	
dv/dt Max. Voltage Rate of Change	10000		V/ μs	(Rated V_R)	

(1) Pulse Width < 300 μs , Duty Cycle <2%

Thermal-Mechanical Specifications

Parameters	Values	Units	Conditions
T_J Max. Junction Temperature Range	-55 to 125	$^\circ\text{C}$	
T_{stg} Max. Storage Temperature Range	-55 to 150	$^\circ\text{C}$	
R_{thJC} Max. Thermal Resistance Junction to Case (Per Leg)	1.5	$^\circ\text{C}/\text{W}$	DC operation * See Fig. 4
R_{thCS} Typical Thermal Resistance Case to Heatsink	0.50	$^\circ\text{C}/\text{W}$	Mounting surface, smooth and greased Only for TO-220
R_{thJA} Max. Thermal Resistance Junction to Ambient	40	$^\circ\text{C}/\text{W}$	DC operation For D ² Pak and TO-262
wt Approximate Weight	2 (0.07)	g (oz.)	
T Mounting Torque	Min.	6 (5)	Kg-cm (lbf-in)
	Max.	12 (10)	
Marking Device	40L15CTS		Case style D ² Pak
	40L15CT-1		Case style TO-262

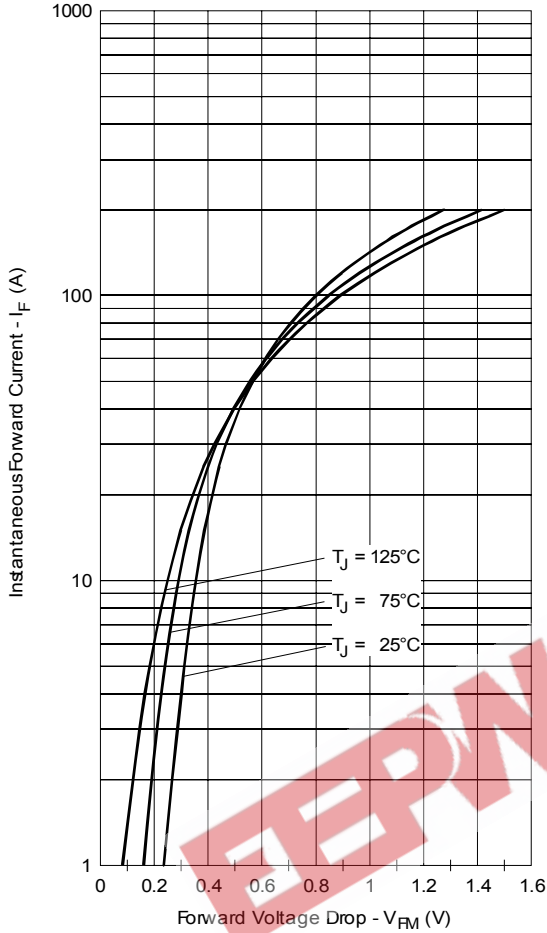

Fig. 1 - Maximum Forward Voltage Drop Characteristics

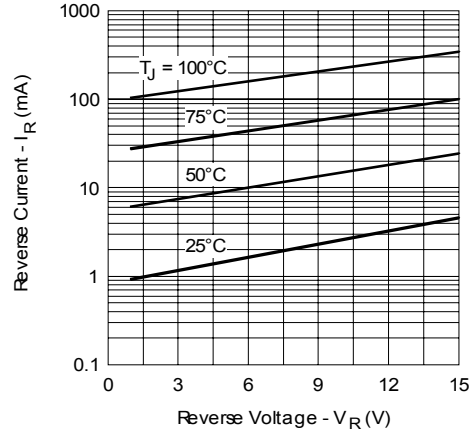

Fig. 2 - Typical Values of Reverse Current Vs. Reverse Voltage

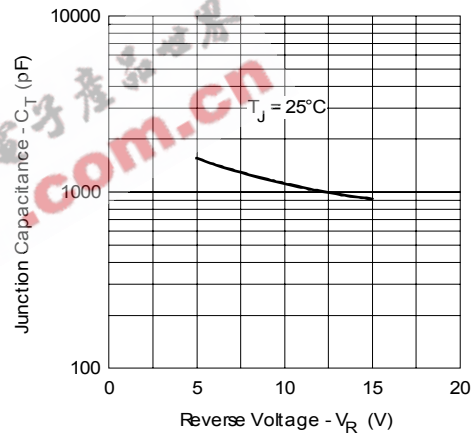

Fig. 3 - Typical Junction Capacitance Vs. Reverse Voltage

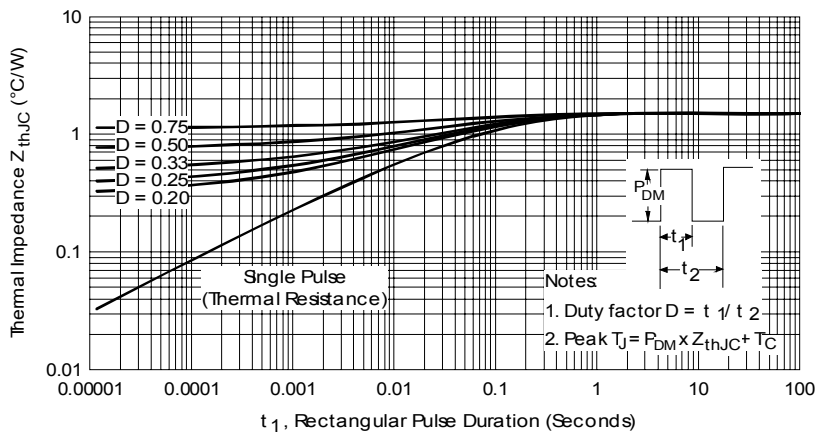

Fig. 4 - Maximum Thermal Impedance Z_{thJC} Characteristics

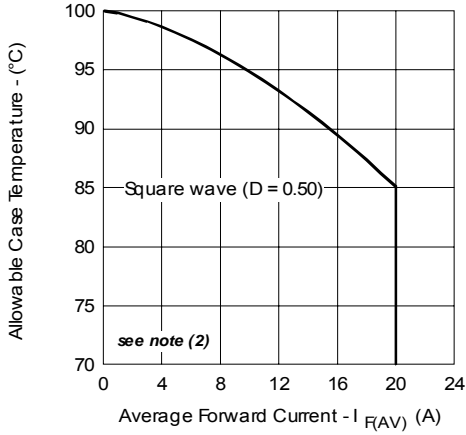

Fig. 5 - Maximum Allowable Case Temperature Vs. Average Forward Current

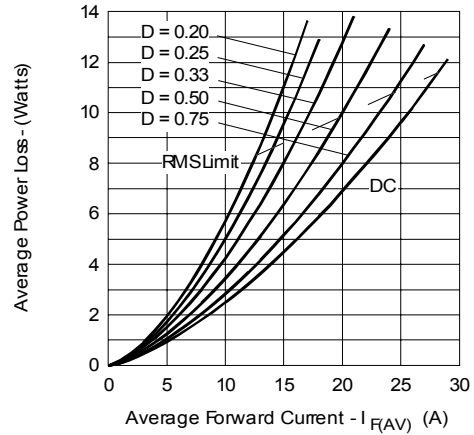

Fig. 6 - Forward Power Loss Characteristics

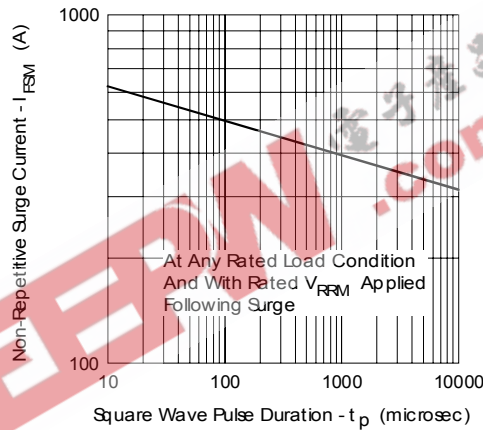

Fig. 7 - Maximum Non-Repetitive Surge Current

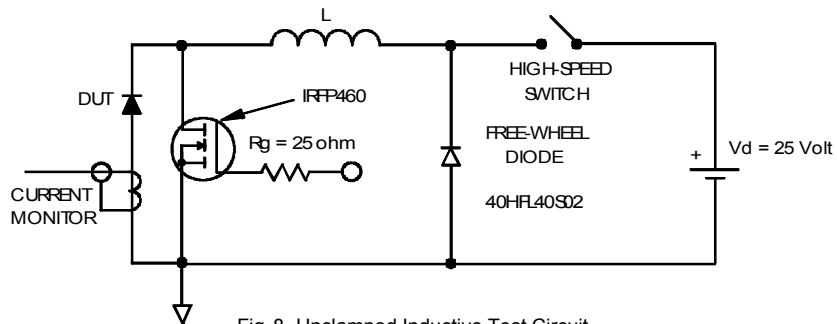

Fig. 8 - Unclamped Inductive Test Circuit

(2) Formula used: $T_c = T_j - (Pd + Pd_{REV}) \times R_{thJC}$;

Pd = Forward Power Loss = $I_{F(AV)} \times V_{FM} @ (I_{F(AV)} / D)$ (see Fig. 6);

Pd_{REV} = Inverse Power Loss = $V_{R1} \times I_{R1} (1 - D)$; $I_{R1} @ V_{R1} = 80\%$ rated V_R

Outlines Table

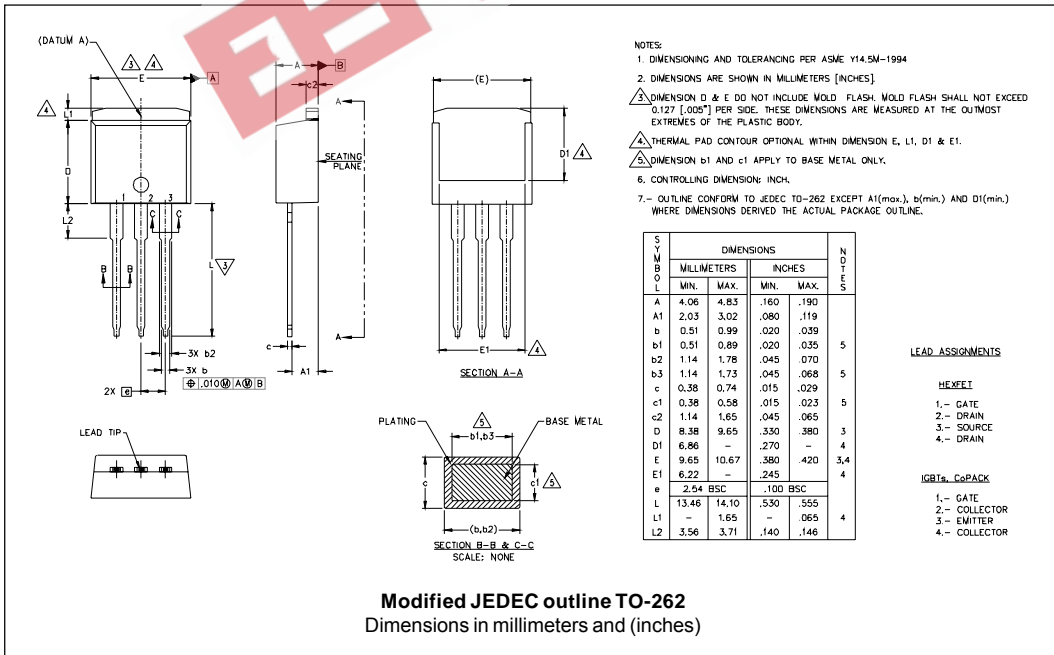
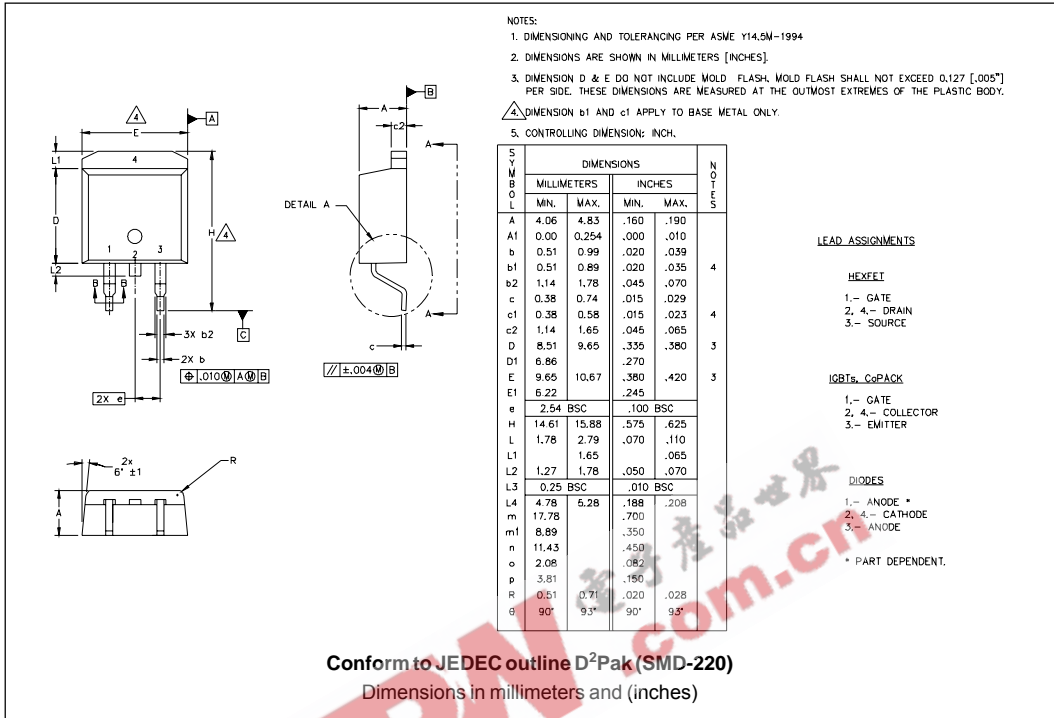

Part Marking Information

D²PAK

EXAMPLE: THIS IS A 40L15CTS
LOT CODE 8024
ASSEMBLED ON WW 02, 2000

Note: "P" in assembly line position indicates "Lead-Free"

INTERNATIONAL RECTIFIER LOGO
ASSEMBLY LOT CODE
PART NUMBER
DATE CODE
YEAR 0 = 2000
WEEK 02
P = LEAD-FREE

TO-262

EXAMPLE: THIS IS A 40L15CT-1
LOT CODE 1789
ASSEMBLED ON WW 19, 2002

Note: "P" in assembly line position indicates "Lead-Free"

INTERNATIONAL RECTIFIER LOGO
ASSEMBLY LOT CODE
PART NUMBER
DATE CODE
YEAR 2 = 2002
WEEK 19
P = LEAD-FREE

Tape & Reel Information

SECTION Y-Y

Ao	10.50	+/-	0.1
Bo	15.80	+/-	0.1
B2	10.25	+/-	0.1
Ko	4.90	+/-	0.1
F	11.50	+/-	0.1
P ₁	16.00	+/-	0.1
W	24.00	+/-	0.3

NOTES:

- 1.0 SPROCKET HOLE PITCH CUMULATIVE TOLERANCE ±0.2
- 2.0 CAMBER NOT TO EXCEED 1mm In 100mm
- 3.0 MATERIAL: CONDUCTIVE BLACK STYRENIC ALLOY
- 4.0 K_o MEASURED FROM A PLANE ON THE INSIDE BOTTOM OF THE POCKET TO THE TOP SURFACE OF THE CARRIER
- 5.0 MEASURED FROM CENTRELINE OF SPROCKET HOLE TO CENTRELINE OF POCKET
- 6.0 VENDOR: (OPTIONAL)
- 7.0 MUST ALSO MEET REQUIREMENTS OF EIA STANDAR #EIA-481A TAPING OF SURFACE MOUNT COMPONENTS FOR AUTOMATIC PLACEMENT
- 8.0 SURFACE RESISTIVITY OF MOLDED MATL. MUST MEASURE LESS OR EQUAL TO 10⁶ OHMS PER SQUARE. MEASURED IN ACCORDANCE TO PROCEDURE GIVEN IN ASTM D-257 & ASTM D-991
- 9.0 TOTAL LENGTH PER REEL MUST BE 45 METERS
- 10.0 © CRITICAL

Dimensions in millimeters and (inches)

Ordering Information Table

Device Code																	
	<table border="1" style="margin: auto;"> <tr> <td style="padding: 5px;">40</td> <td style="padding: 5px;">L</td> <td style="padding: 5px;">15</td> <td style="padding: 5px;">C</td> <td style="padding: 5px;">T</td> <td style="padding: 5px;">S</td> <td style="padding: 5px;">TRL</td> <td style="padding: 5px;">PbF</td> </tr> <tr> <td style="text-align: center;">①</td> <td style="text-align: center;">②</td> <td style="text-align: center;">③</td> <td style="text-align: center;">④</td> <td style="text-align: center;">⑤</td> <td style="text-align: center;">⑥</td> <td style="text-align: center;">⑦</td> <td style="text-align: center;">⑧</td> </tr> </table>	40	L	15	C	T	S	TRL	PbF	①	②	③	④	⑤	⑥	⑦	⑧
40	L	15	C	T	S	TRL	PbF										
①	②	③	④	⑤	⑥	⑦	⑧										
1	- Current Rating (40A)																
2	- L = Schottky L Series																
3	- Voltage Rating (15V)																
4	- C = Common Cathode																
5	- T = TO-220																
6	- • S = D ² Pak • -1= TO-262																
7	- • none = Tube (50 pieces) • TRL = Tape & Reel (Left Oriented - for D ² Pak only) • TRR = Tape & Reel (Right Oriented - for D ² Pak only)																
8	- • none = Standard Production • PbF = Lead-Free																

Data and specifications subject to change without notice.
 This product has been designed and qualified for Industrial Level and Lead-Free.
 Qualification Standards can be found on IR's Web site.