

## 74VHC139 Dual 2-to-4 Decoder/Demultiplexer

### General Description

The VHC139 is an advanced high speed CMOS Dual 2-to-4 Decoder/Demultiplexer fabricated with silicon gate CMOS technology. It achieves the high speed operation similar to equivalent Bipolar Schottky TTL while maintaining the CMOS low power dissipation.

The active LOW enable input can be used for gating or it can be used as a data input for demultiplexing applications. When the enable input is held HIGH, all four outputs are fixed at a HIGH logic level independent of the other inputs. An input protection circuit ensures that 0V to 7V can be applied to the input pins without regard to the supply volt-

age. This device can be used to interface 5V to 3V systems and two supply systems such as battery back up. This circuit prevents device destruction due to mismatched supply and input voltages.

### Features

- High Speed:  $t_{PD} = 5.0$  ns (typ) at  $T_A = 25^\circ\text{C}$
- Low power dissipation:  $I_{CC} = 4$   $\mu\text{A}$  (Max.) at  $T_A = 25^\circ\text{C}$
- High noise immunity:  $V_{NIH} = V_{NIL} = 28\%$   $V_{CC}$  (Min.)
- Power down protection is provided on all inputs
- Pin and function compatible with 74HC139

### Ordering Code:

Order Number	Package Number	Package Description
74VHC139M	M16A	16-Lead Small Outline Integrated Circuit (SOIC), JEDEC MS-012, 0.150" Narrow
74VHC139SJ	M16D	16-Lead Small Outline Package (SOP), EIAJ TYPE II, 5.3mm Wide
74VHC139MTC	MTC16	16-Lead Thin Shrink Small Outline Package (TSSOP), JEDEC MO-153, 4.4mm Wide
74VHC139N	N16E	16-Lead Plastic Dual-In-Line Package (PDIP), JEDEC MS-001, 0.300" Wide

Surface mount packages are also available on Tape and Reel. Specify by appending the suffix letter "X" to the ordering code.

### Connection Diagram

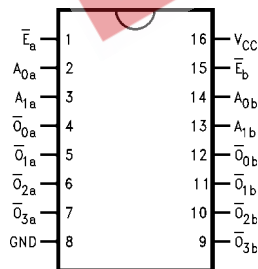

### Pin Description

Pin Names	Description
$A_0, A_1$	Address Inputs
$\bar{E}$	Enable Inputs
$\bar{O}_0\text{--}\bar{O}_3$	Outputs

### Truth Table

Inputs			Outputs			
$\bar{E}$	$A_0$	$A_1$	$\bar{O}_0$	$\bar{O}_1$	$\bar{O}_2$	$\bar{O}_3$
H	X	X	H	H	H	H
L	L	L	L	H	H	H
L	H	L	H	L	H	H
L	L	H	H	H	L	H
L	H	H	H	H	H	L

H = HIGH Voltage Level  
L = LOW Voltage Level  
X = Immaterial

**Logic Symbols**

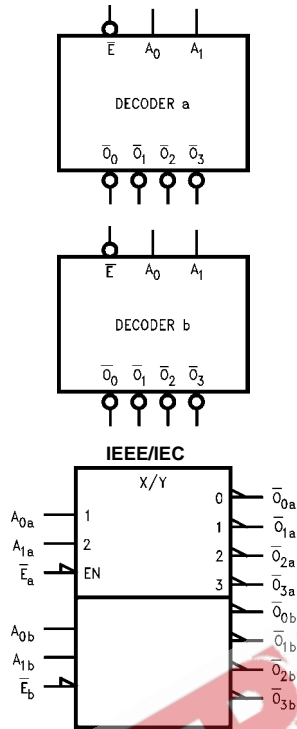

**Functional Description**

The VHC139 is a high-speed dual 2-to-4 decoder/demultiplexer. The device has two independent decoders, each of which accepts two binary weighted inputs ( $A_0$ – $A_1$ ) and provides four mutually exclusive active-LOW outputs ( $\bar{O}_0$ – $\bar{O}_3$ ). Each decoder has an active-LOW enable ( $\bar{E}$ ). When  $\bar{E}$  is HIGH all outputs are forced HIGH. The enable can be used as the data input for a 4-output demultiplexer application. Each half of the VHC139 generates all four minterms of two variables. These four minterms are useful in some applications, replacing multiple gate functions as shown in *Figure 1*, and thereby reducing the number of packages required in a logic network.

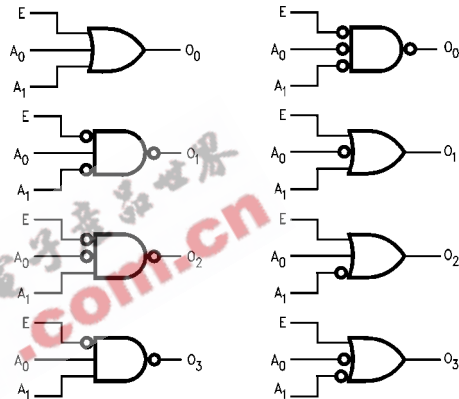
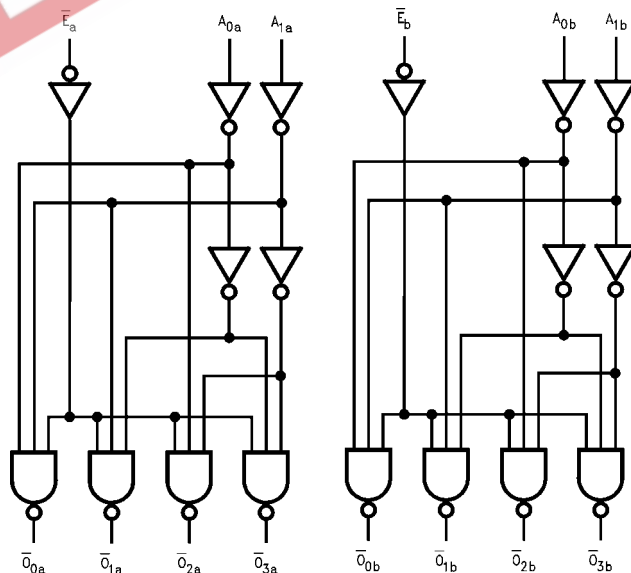

FIGURE 1. Gate Functions (Each Half)

**Logic Diagram**



Please note that this diagram is provided only for the understanding of logic operations and should not be used to estimate propagation delays.

**Absolute Maximum Ratings** (Note 1)

Supply Voltage ( $V_{CC}$ )	-0.5V to +7.0V
DC Input Voltage ( $V_{IN}$ )	-0.5V to +7.0V
DC Output Voltage ( $V_{OUT}$ )	-0.5V to $V_{CC} + 0.5V$
Input Diode Current ( $I_{IK}$ )	-20 mA
Output Diode Current ( $I_{OK}$ )	$\pm 20$ mA
DC Output Current ( $I_{OUT}$ )	$\pm 25$ mA
DC $V_{CC}/GND$ Current ( $I_{CC}$ )	$\pm 75$ mA
Storage Temperature ( $T_{STG}$ )	-65°C to +150°C
Lead Temperature ( $T_L$ ) (Soldering, 10 seconds)	260°C

**Recommended Operating Conditions** (Note 2)

Supply Voltage ( $V_{CC}$ )	2.0V to +5.5V
Input Voltage ( $V_{IN}$ )	0V to +5.5V
Output Voltage ( $V_{OUT}$ )	0V to $V_{CC}$
Operating Temperature ( $T_{OPR}$ )	-40°C to +85°C
Input Rise and Fall Time ( $t_r, t_f$ )	
$V_{CC} = 3.3V \pm 0.3V$	0 ~ 100 ns/V
$V_{CC} = 5.0V \pm 0.5V$	0 ~ 20 ns/V

**Note 1:** Absolute Maximum Ratings are values beyond which the device may be damaged or have its useful life impaired. The databook specifications should be met, without exception, to ensure that the system design is reliable over its power supply, temperature, and output/input loading variables. Fairchild does not recommend operation outside databook specifications.

**Note 2:** Unused inputs must be held HIGH or LOW. They may not float.

**DC Electrical Characteristics**

Symbol	Parameter	$V_{CC}$ (V)	$T_A = 25^\circ\text{C}$			$T_A = -40^\circ\text{C to } +85^\circ\text{C}$		Units	Conditions	
			Min	Typ	Max	Min	Max			
$V_{IH}$	HIGH Level Input Voltage	2.0 3.0 – 5.5	1.50 0.7 $V_{CC}$			1.50 0.7 $V_{CC}$		V		
$V_{IL}$	LOW Level Input Voltage	2.0 3.0 – 5.5			0.50 0.3 $V_{CC}$	0.50 0.3 $V_{CC}$		V		
$V_{OH}$	HIGH Level Output Voltage	2.0	1.9	2.0		1.9		V	$V_{IN} = V_{IH}$ or $V_{IL}$	$I_{OH} = -50 \mu\text{A}$
		3.0	2.9	3.0		2.9				
		4.5	4.4	4.5		4.4		V	$I_{OH} = -4 \text{ mA}$ $I_{OH} = -8 \text{ mA}$	
		3.0	2.58			2.48				
4.5	3.94			3.80						
$V_{OL}$	LOW Level Output Voltage	2.0		0.0	0.1		0.1	V	$V_{IN} = V_{IH}$ or $V_{IL}$	$I_{OL} = 50 \mu\text{A}$
		3.0		0.0	0.1		0.1			
		4.5		0.0	0.1		0.1	V	$I_{OL} = 4 \text{ mA}$ $I_{OL} = 8 \text{ mA}$	
		3.0			0.36		0.44			
4.5			0.36		0.44					
$I_{IN}$	Input Leakage Current	0 – 5.5			$\pm 0.1$	$\pm 1.0$		$\mu\text{A}$	$V_{IN} = 5.5V$ or GND	
$I_{CC}$	Quiescent Supply Current	5.5			4.0	40.0		$\mu\text{A}$	$V_{IN} = V_{CC}$ or GND	

**AC Electrical Characteristics**

Symbol	Parameter	$V_{CC}$ (V)	$T_A = 25^\circ\text{C}$			$T_A = -40^\circ\text{C to } +85^\circ\text{C}$		Units	Conditions
			Min	Typ	Max	Min	Max		
$t_{PLH}$	Propagation Delay $A_n$ to $\bar{O}_n$	$3.3 \pm 0.3$		7.2	11.0	1.0	13.0	ns	$C_L = 15 \text{ pF}$
$t_{PHL}$				9.7	14.5	1.0	16.5		$C_L = 50 \text{ pF}$
		$5.0 \pm 0.5$		5.0	7.2	1.0	8.5	ns	$C_L = 15 \text{ pF}$
				6.5	9.2	1.0	10.5		$C_L = 50 \text{ pF}$
$t_{PLH}$	Propagation Delay $\bar{E}_n$ to $\bar{O}_n$	$3.3 \pm 0.3$		6.4	9.2	1.0	11.0	ns	$C_L = 15 \text{ pF}$
$t_{PHL}$				8.9	12.7	1.0	14.5		$C_L = 50 \text{ pF}$
		$5.0 \pm 0.5$		4.4	6.3	1.0	7.5	ns	$C_L = 15 \text{ pF}$
				5.9	8.3	1.0	9.5		$C_L = 50 \text{ pF}$
$C_{IN}$	Input Capacitance			4	10		10	pF	$V_{CC} = \text{Open}$
$C_{PD}$	Power Dissipation Capacitance			26				pF	(Note 3)

**Note 3:**  $C_{PD}$  is defined as the value of the internal equivalent capacitance which is calculated from the operating current consumption without load. Average operating current can be obtained by the equation:  $I_{CC}(\text{opr}) = C_{PD} * V_{CC} * f_{IN} + I_{CC}/2$  (per decoder).

**Physical Dimensions** inches (millimeters) unless otherwise noted

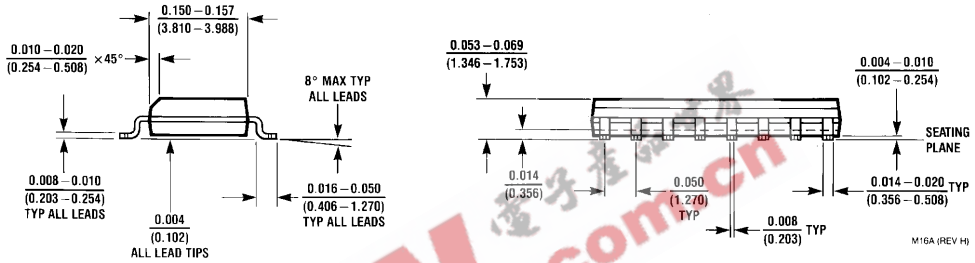
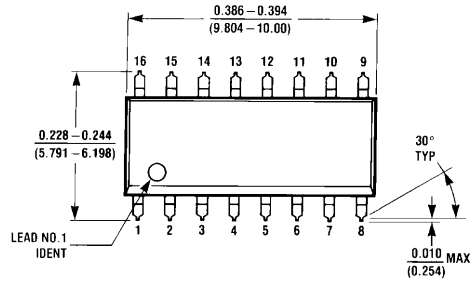

**16-Lead Small Outline Integrated Circuit (SOIC), JEDEC MS-012, 0.150" Narrow  
Package Number M16A**

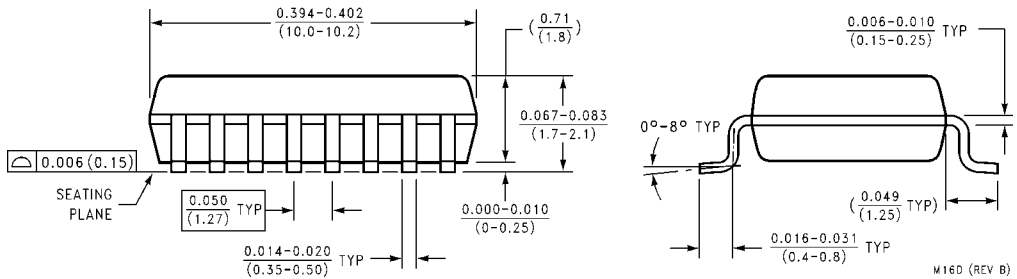
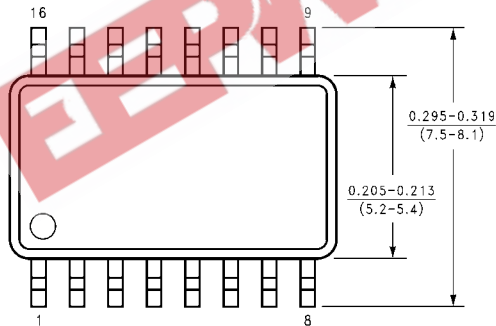

**16-Lead Small Outline Package (SOP), EIAJ TYPE II, 5.3mm Wide  
Package Number M16D**

**Physical Dimensions** inches (millimeters) unless otherwise noted (Continued)

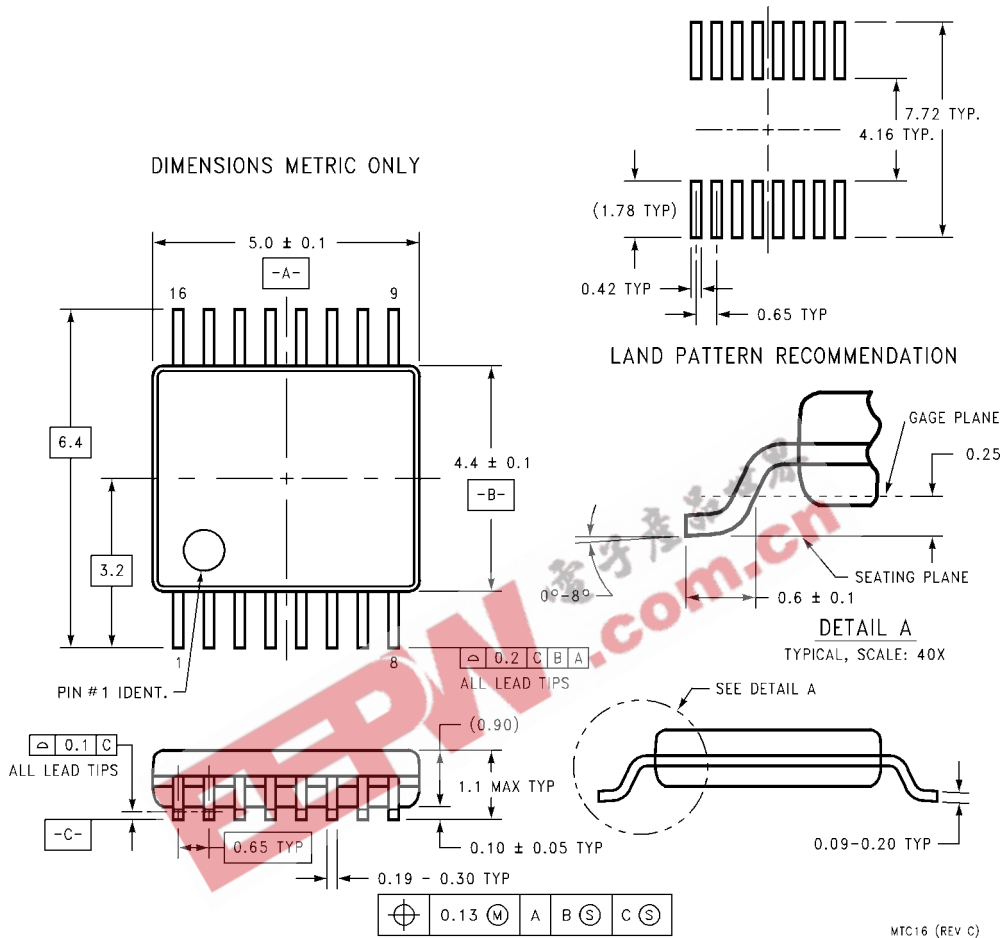

**16-Lead Thin Shrink Small Outline Package (TSSOP), JEDEC MO-153, 4.4mm Wide  
Package Number MTC16**

MTC16 (REV C)

