

54F/74F398 • 54F/74F399 Quad 2-Port Register

General Description

The 'F398 and 'F399 are the logical equivalents of a quad 2-input multiplexer feeding into four edge-triggered flip-flops. A common Select input determines which of the two 4-bit words is accepted. The selected data enters the flip-flops on the rising edge of the clock. The 'F399 is the 16-pin version of the 'F398, with only the Q outputs of the flip-flops available.

Features

- Select inputs from two data sources
- Fully positive edge-triggered operation
- Both true and complement outputs—'F398
- Guaranteed 4000V minimum ESD protection—'F399

Commercial	Military	Package Number	Package Description
74F398PC		N20A	20-Lead (0.300" Wide) Molded Dual-In-Line
	54F398DM (Note 2)	J20A	20-Lead Ceramic Dual-In-Line
74F398SC (Note 1)		M20B	20-Lead (0.300" Wide) Molded Small Outline, JEDEC
	54F398FM (Note 2)	W20A	20-Lead Cerpack
	54F398LM (Note 2)	E20A	20-Lead Ceramic Leadless Chip Carrier, Type C
74F399PC		N20A	20-Lead (0.300" Wide) Molded Dual-In-Line
	54F399DM (Note 2)	J20A	20-Lead Ceramic Dual-In-Line
74F399SC (Note 1)		M20B	20-Lead (0.300" Wide) Molded Small Outline, JEDEC
74F399SJ (Note 1)		M20D	20-Lead (0.300" Wide) Molded Small Outline, EIAJ
	54F399FM (Note 2)	W20A	20-Lead Cerpack
	54F399LM (Note 2)	E20A	20-Lead Ceramic Leadless Chip Carrier, Type C

Note 1: Devices also available in 13" reel. Use suffix = SCX and SJX.

Note 2: Military grade device with environmental and burn-in processing. Use suffix = DMOB, FMOB and LMOB.

Connection Diagrams

'F398

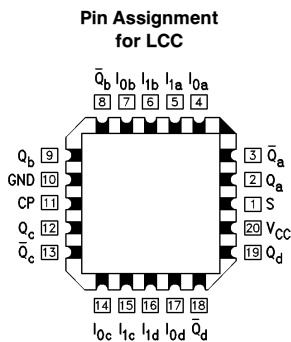

TL/F/9533-5

Pin Assignment for DIP, SOIC and Flatpak

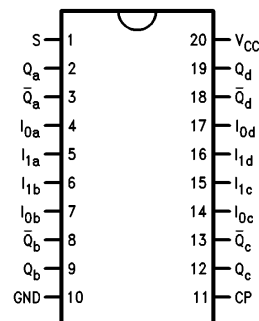

TL/F/9533-6

TRI-STATE® is a registered trademark of National Semiconductor Corporation.

Connection Diagrams (Continued)

'F399

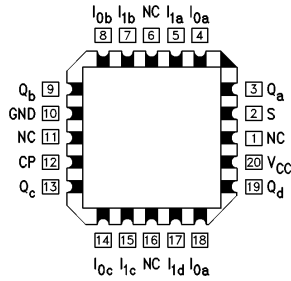

TL/F/9533-7

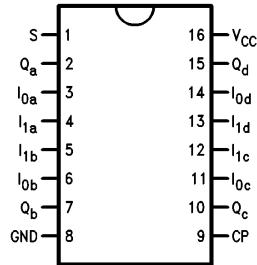

TL/F/9533-8

Logic Symbols

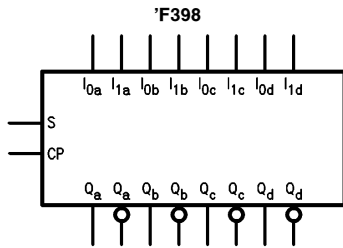

TL/F/9533-2

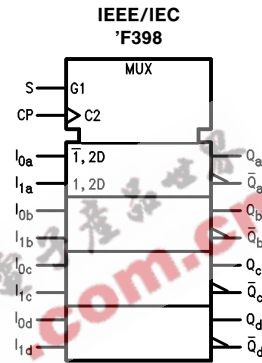

TL/F/9533-1

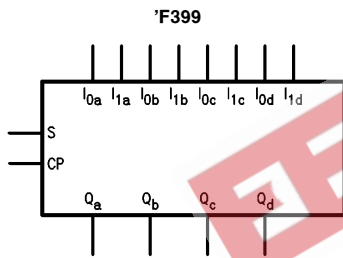

TL/F/9533-4

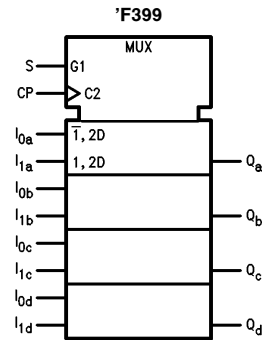

TL/F/9533-3

Unit Loading/Fan Out

Pin Names	Description	54F/74F	
		U.L. HIGH/LOW	Input I_{IH}/I_{IL} Output I_{OH}/I_{OL}
S	Common Select Input	1.0/1.0	20 μ A/ -0.6 mA
CP	Clock Pulse Input (Active Rising Edge)	1.0/1.0	20 μ A/ -0.6 mA
I_{0a} - I_{0d}	Data Inputs from Source 0	1.0/1.0	20 μ A/ -0.6 mA
I_{1a} - I_{1d}	Data Inputs from Source 1	1.0/1.0	20 μ A/ -0.6 mA
Q_a - Q_d	Register True Outputs	50/33.3	-1 mA/20 mA
\bar{Q}_a - \bar{Q}_d	Register Complementary Outputs ('F398)	50/33.3	-1 mA/20 mA

Functional Description

The 'F398 and 'F399 are high-speed quad 2-port registers. They select four bits of data from either of two sources (Ports) under control of a common Select input (S). The selected data is transferred to a 4-bit output register synchronous with the LOW-to-HIGH transition of the Clock input (CP). The 4-bit D-type output register is fully edge-triggered. The Data inputs (I_{0x}, I_{1x}) and Select input (S) must be stable only a setup time prior to and hold time after the LOW-to-HIGH transition of the Clock input for predictable operation. The 'F398 has both Q and \bar{Q} outputs.

Function Table

S	Inputs		Outputs	
	I_0	I_1	Q	\bar{Q}^*
l	l	X	L	H
l	h	X	H	L
h	X	l	L	H
h	X	h	H	L

H = HIGH Voltage Level
 L = LOW Voltage Level
 h = HIGH Voltage Level one setup time prior to the LOW-to-HIGH clock transition
 l = LOW Voltage Level one setup time prior to the LOW-to-HIGH clock transition
 X = Immaterial
 *F398 only

Logic Diagram

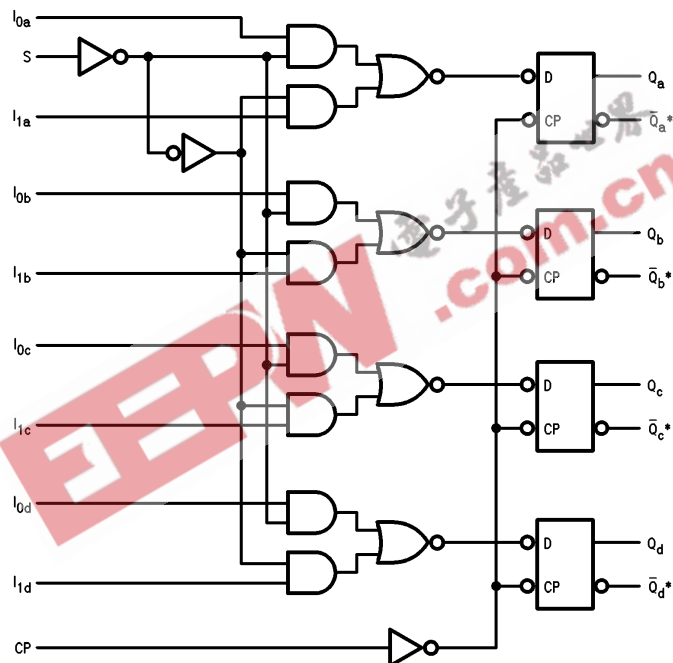

TL/F/9533-9

**F398 Only

Please note that this diagram is provided only for the understanding of logic operations and should not be used to estimate propagation delays.

Absolute Maximum Ratings (Note 1)

If Military/Aerospace specified devices are required, please contact the National Semiconductor Sales Office/Distributors for availability and specifications.

Storage Temperature	-65°C to +150°C
Ambient Temperature under Bias	-55°C to +125°C
Junction Temperature under Bias	-55°C to +175°C
Plastic	-55°C to +150°C
V _{CC} Pin Potential to Ground Pin	-0.5V to +7.0V
Input Voltage (Note 2)	-0.5V to +7.0V
Input Current (Note 2)	-30 mA to +5.0 mA
Voltage Applied to Output in HIGH State (with V _{CC} = 0V)	
Standard Output	-0.5V to V _{CC}
TRI-STATE® Output	-0.5V to +5.5V

Current Applied to Output in LOW State (Max) twice the rated I_{OL} (mA)

ESD Last Passing Voltage (Min)—F399 4000V

Note 1: Absolute maximum ratings are values beyond which the device may be damaged or have its useful life impaired. Functional operation under these conditions is not implied.

Note 2: Either voltage limit or current limit is sufficient to protect inputs.

Recommended Operating Conditions

Free Air Ambient Temperature	
Military	-55°C to +125°C
Commercial	0°C to +70°C
Supply Voltage	
Military	+4.5V to +5.5V
Commercial	+4.5V to +5.5V

DC Electrical Characteristics

Symbol	Parameter	54F/74F			Units	V _{CC}	Conditions
		Min	Typ	Max			
V _{IH}	Input HIGH Voltage	2.0			V		Recognized as a HIGH Signal
V _{IL}	Input LOW Voltage			0.8	V		Recognized as a LOW Signal
V _{CD}	Input Clamp Diode Voltage			-1.2	V	Min	I _{IN} = -18 mA
V _{OH}	Output HIGH Voltage	54F 10% V _{CC} 74F 10% V _{CC} 74F 5% V _{CC}	2.5 2.5 2.7		V	Min	I _{OH} = -1 mA I _{OH} = -1 mA I _{OH} = -1 mA
V _{OL}	Output LOW Voltage	54F 10% V _{CC} 74F 10% V _{CC}		0.5 0.5	V	Min	I _{OL} = 20 mA I _{OL} = 20 mA
I _{IH}	Input HIGH Current	54F 74F		20.0 5.0	μA	Max	V _{IN} = 2.7V
I _{BVI}	Input HIGH Current Breakdown Test	54F 74F		100 7.0	μA	Max	V _{IN} = 7.0V
I _{CEX}	Output HIGH Leakage Current	54F 74F		250 50	μA	Max	V _{OUT} = V _{CC}
V _{ID}	Input Leakage Test	74F	4.75		V	0.0	I _{ID} = 1.9 μA All Other Pins Grounded
I _{OD}	Output Leakage Circuit Current	74F		3.75	μA	0.0	V _{IOD} = 150 mV All Other Pins Grounded
I _{IL}	Input LOW Current			-0.6	mA	Max	V _{IN} = 0.5V
I _{OS}	Output Short-Circuit Current		-60	-150	mA	Max	V _{OUT} = 0V
I _{CCH}	Power Supply Current (F398)		25	38	mA	Max	V _O = HIGH
I _{CCL}	Power Supply Current (F398)		25	38	mA	Max	V _O = LOW
I _{CCH}	Power Supply Current (F399)		22	34	mA	Max	V _O = HIGH
I _{CCL}	Power Supply Current (F399)		22	34	mA	Max	V _O = LOW

AC Electrical Characteristics									
Symbol	Parameter	74F			54F		74F		Units
		T _A = +25°C V _{CC} = +5.0V C _L = 50 pF			T _A , V _{CC} = Mil C _L = 50 pF		T _A , V _{CC} = Com C _L = 50 pF		
		Min	Typ	Max	Min	Max	Min	Max	
f _{max}	Input Clock Frequency	100	140		80		100		MHz
t _{PLH}	Propagation Delay	3.0*	5.7	7.5	3.0	9.5	3.0	8.5	ns
t _{PHL}	CP to Q or \bar{Q}	3.0	6.8	9.0	3.0	11.5	3.0	10.0	
*F398 3.3 ns									
AC Operating Requirements									
Symbol	Parameter	74F		54F		74F		Units	
		T _A = +25°C V _{CC} = +5.0V		T _A , V _{CC} = Mil		T _A , V _{CC} = Com			
		Min	Max	Min	Max	Min	Max		
t _s (H)	Setup Time, HIGH or LOW	3.0		4.5		3.0		ns	
t _s (L)	I _n to CP	3.0		4.5		3.0			
t _h (H)	Hold Time, HIGH or LOW	1.0		1.5		1.0		ns	
t _h (L)	I _n to CP	1.0		1.5		1.0			
t _s (H)	Setup Time, HIGH or LOW	7.5		10.5		8.5		ns	
t _s (L)	S to CP ('F398)	7.5		10.5		8.5			
t _s (H)	Setup Time, HIGH or LOW	7.5		9.5		8.5		ns	
t _s (L)	S to CP ('F399)	7.5		9.5		8.5			
t _h (H)	Hold Time, HIGH or LOW	0		0		0		ns	
t _h (L)	S to CP	0		0		0			
t _w (H)	CP Pulse Width	4.0		4.0		4.0		ns	
t _w (L)	HIGH or LOW	5.0		7.0		5.0			

Ordering Information

The device number is used to form part of a simplified purchasing code where the package type and temperature range are defined as follows:

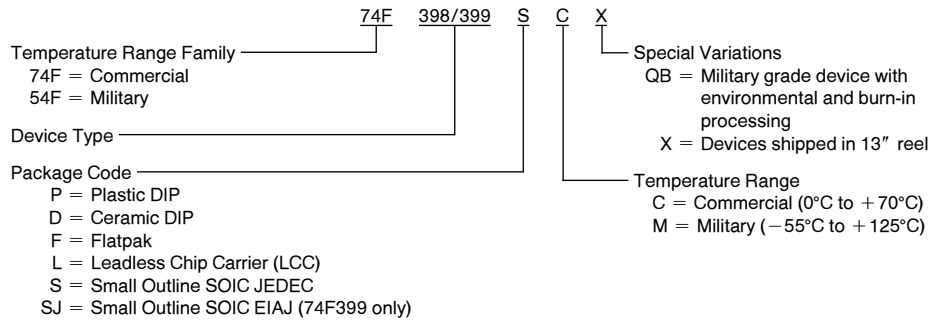

EEPW 电子产品世界
.com.cn

Physical Dimensions inches (millimeters)

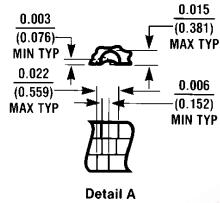
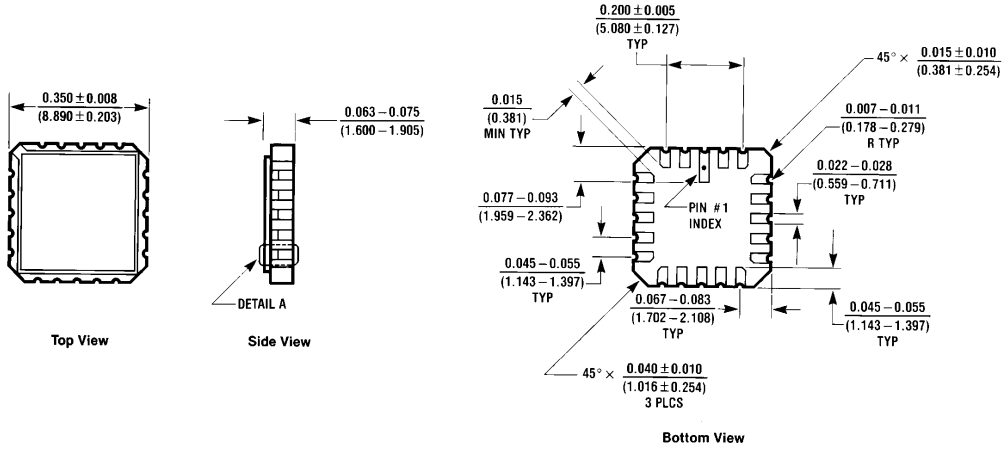

20-Lead Ceramic Leadless Chip Carrier (L)
NS Package Number E20A

E20A (REV D)

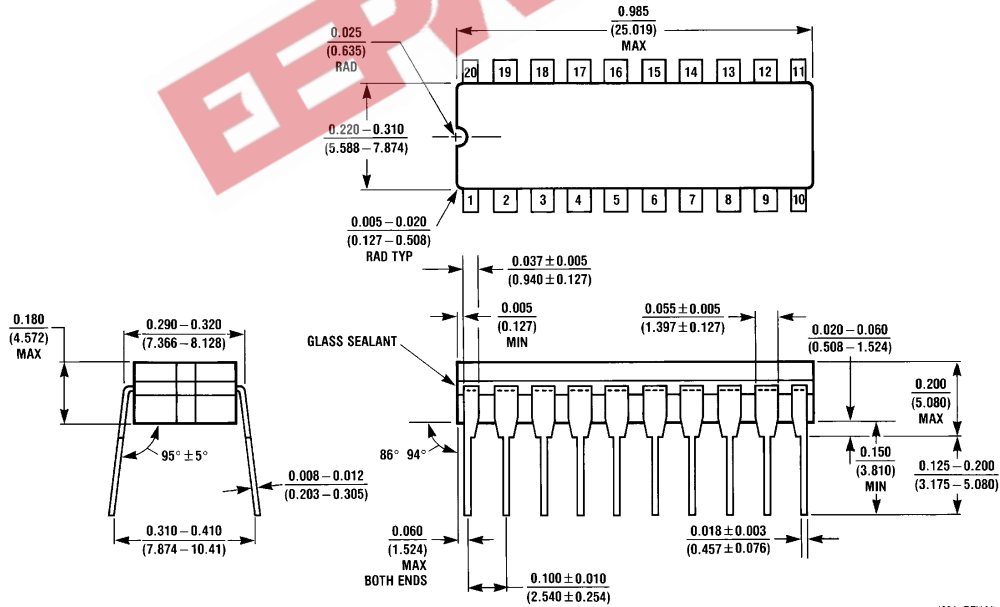

20-Lead Ceramic Dual-In-Line Package (D)
NS Package Number J20A

Physical Dimensions inches (millimeters) (Continued)

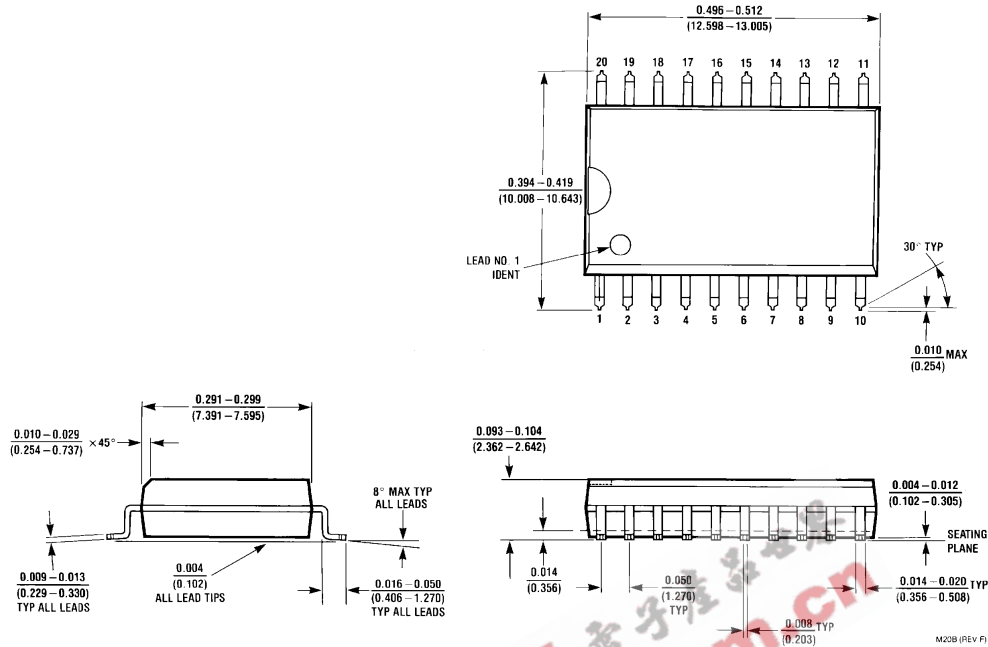

**20-Lead (0.300" Wide) Molded Small Outline Package, JEDEC (S)
NS Package Number M20B**

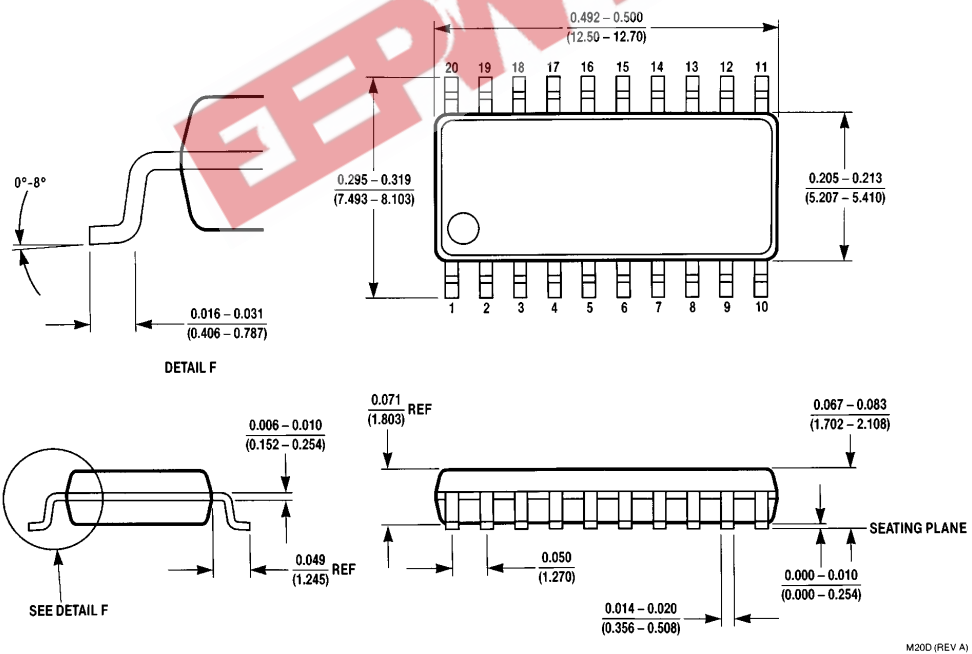

**20-Lead (0.300" Wide) Molded Small Outline Package, EIAJ (SJ)
NS Package Number M20D**

Physical Dimensions inches (millimeters) (Continued)

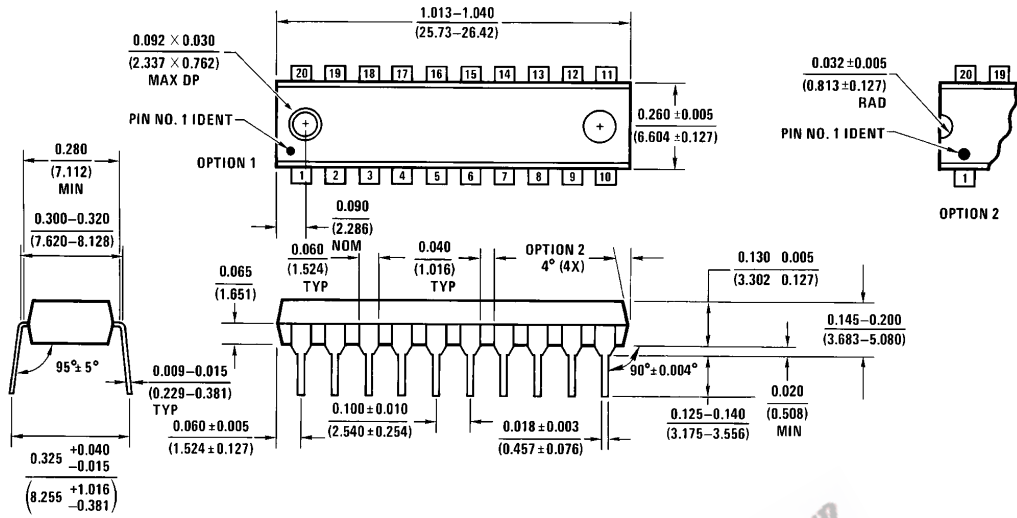

20-Lead (0.300" Wide) Molded Dual-In-Line Package (P)
NS Package Number N20A

N20A (REV G)

EEPW.com.cn 电子产品世界

Physical Dimensions inches (millimeters) (Continued)

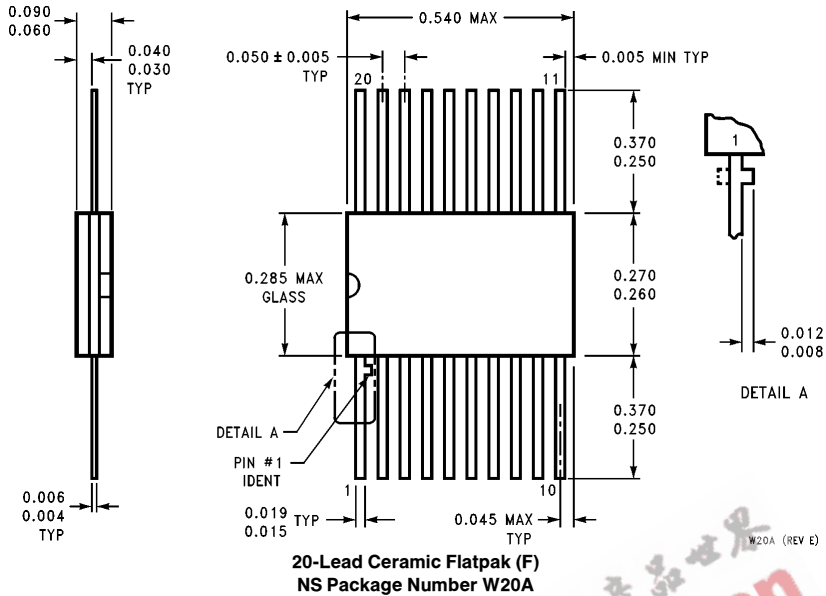

EEPW.com.cn 电子產品世界 W20A (REV E)

LIFE SUPPORT POLICY

NATIONAL'S PRODUCTS ARE NOT AUTHORIZED FOR USE AS CRITICAL COMPONENTS IN LIFE SUPPORT DEVICES OR SYSTEMS WITHOUT THE EXPRESS WRITTEN APPROVAL OF THE PRESIDENT OF NATIONAL SEMICONDUCTOR CORPORATION. As used herein:

1. Life support devices or systems are devices or systems which, (a) are intended for surgical implant into the body, or (b) support or sustain life, and whose failure to perform, when properly used in accordance with instructions for use provided in the labeling, can be reasonably expected to result in a significant injury to the user.
2. A critical component is any component of a life support device or system whose failure to perform can be reasonably expected to cause the failure of the life support device or system, or to affect its safety or effectiveness.

 <p>National Semiconductor Corporation 2900 Semiconductor Drive P.O. Box 58090 Santa Clara, CA 95052-8090 Tel: 1 (800) 272-9959 TWX: (910) 339-9240</p>	<p>National Semiconductor GmbH Livry-Gargan-Str. 10 D-82256 Fürstenfeldbruck Germany Tel: (81-41) 35-0 Telex: 527649 Fax: (81-41) 35-1</p>	<p>National Semiconductor Japan Ltd. Sumitomo Chemical Engineering Center Bldg. 7F 1-7-1, Nakase, Mihama-Ku Chiba-City, Chiba Prefecture 261 Tel: (043) 299-2300 Fax: (043) 299-2500</p>	<p>National Semiconductor Hong Kong Ltd. 13th Floor, Straight Block, Ocean Centre, 5 Canton Rd. Tsimshatsui, Kowloon Hong Kong Tel: (852) 2737-1600 Fax: (852) 2736-9960</p>	<p>National Semiconductores Do Brazil Ltda. Rua Deputado Lacorda Franco 120-3A Sao Paulo-SP Brazil 05418-000 Tel: (55-11) 212-5066 Telex: 391-1131931 NSBR BR Fax: (55-11) 212-1181</p>	<p>National Semiconductor (Australia) Pty, Ltd. Building 16 Business Park Drive Monash Business Park Nottingham, Melbourne Victoria 3168 Australia Tel: (3) 558-9889 Fax: (3) 558-9898</p>
---	---	---	---	--	---

National does not assume any responsibility for use of any circuitry described, no circuit patent licenses are implied and National reserves the right at any time without notice to change said circuitry and specifications.