

54F/74F158A Quad 2-Input Multiplexer

General Description

The 'F158A is a high speed quad 2-input multiplexer. It selects four bits of data from two sources using the common Select and Enable inputs. The four outputs present the selected data in the inverted form. The 'F158A can also generate any four of the 16 different functions of two variables.

Features

- Guaranteed 4000V minimum ESD protection

Commercial	Military	Package Number	Package Description
74F158APC		N16E	16-Lead (0.300" Wide) Molded Dual-In-Line
	54F158ADM (Note 2)	J16A	16-Lead Ceramic Dual-In-Line
74F158ASC (Note 1)		M16A	16-Lead (0.150" Wide) Molded Small Outline, JEDEC
74F158ASJ (Note 1)		M16D	16-Lead (0.300" Wide) Molded Small Outline, EIAJ
	54F158AFM (Note 2)	W16A	16-Lead Cerpack
	54F158ALM (Note 2)	E20A	20-Lead Ceramic Leadless Chip Carrier, Type C

Note 1: Devices also available in 13" reel. Use suffix = SCX and SJX.

Note 2: Military grade device with environmental and burn-in processing. Use suffix = DMQB, FMQB and LMQB.

Logic Symbols

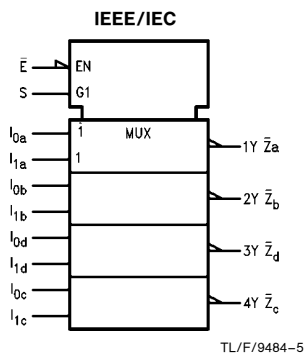
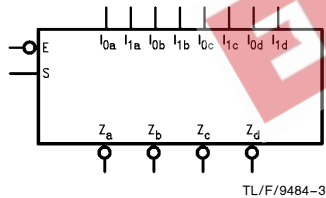

Connection Diagrams

Pin Assignment for DIP, SOIC and Flatpak

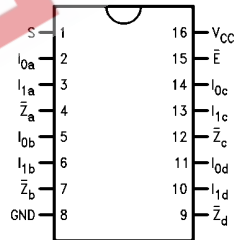

Pin Assignment for LCC

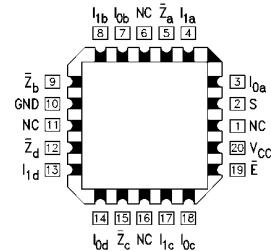

TRI-STATE® is a registered trademark of National Semiconductor Corporation.

Unit Loading/Fan Out

Pin Names	Description	54F/74F	
		U.L. HIGH/LOW	Input I_{IH}/I_{IL} Output I_{OH}/I_{OL}
$I_{0a}-I_{0d}$	Source 0 Data Inputs	1.0/1.0	20 μ A/ -0.6 mA
$I_{1a}-I_{1d}$	Source 1 Data Inputs	1.0/1.0	20 μ A/ -0.6 mA
\bar{E}	Enable Input (Active LOW)	1.0/1.0	20 μ A/ -0.6 mA
S	Select Input	1.0/1.0	20 μ A/ -0.6 mA
$\bar{Z}_a-\bar{Z}_d$	Inverted Outputs	50/33.3	-1 mA/20 mA

Functional Description

The 'F158A quad 2-input multiplexer selects four bits of data from two sources under the control of a common Select input (S) and presents the data in inverted form at the four outputs. The Enable input (\bar{E}) is active LOW. When \bar{E} is HIGH, all of the outputs (\bar{Z}) are forced HIGH regardless of all other inputs. The 'F158A is the logic implementation of a 4-pole, 2-position switch where the position of the switch is determined by the logic levels supplied to the Select input.

A common use of the 'F158A is the moving of data from two groups of registers to four common output busses. The particular register from which the data comes is determined by the state of the Select input. A less obvious use is as a function generator. The 'F158A can generate four functions of two variables with one variable common. This is useful for implementing gating functions.

Truth Table

Inputs				Outputs
\bar{E}	S	I_0	I_1	\bar{Z}
H	X	X	X	H
L	L	L	X	H
L	L	H	X	L
L	H	X	L	H
L	H	X	H	L

H = HIGH Voltage Level

L = LOW Voltage Level

X = Immaterial

$\bar{Z}_n = \bar{E} \times (I_{1n} S + I_{0n} \bar{S})$

Logic Diagram

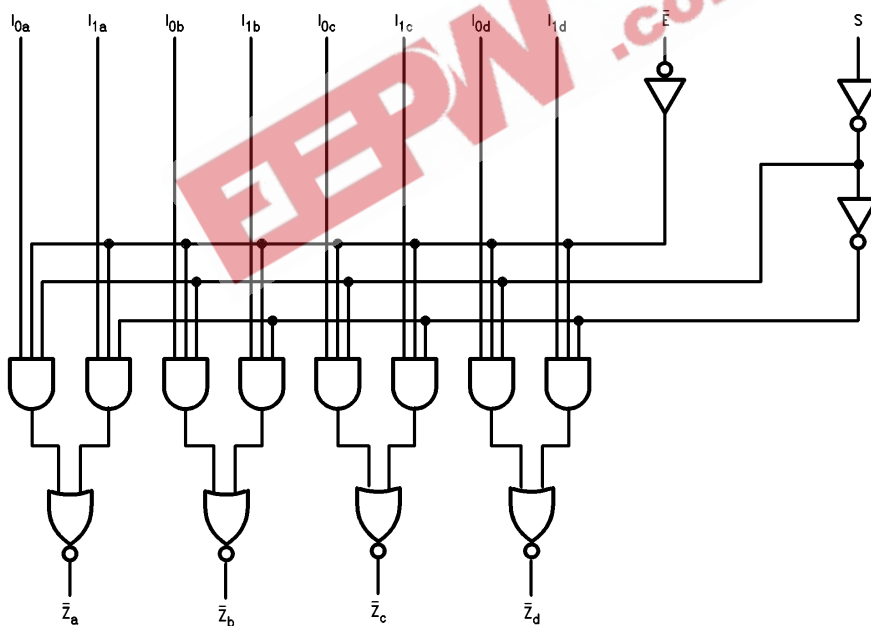

TL/F/9484-4

Please note that this diagram is provided only for the understanding of logic operations and should not be used to estimate propagation delays.

Absolute Maximum Ratings (Note 1)

If Military/Aerospace specified devices are required, please contact the National Semiconductor Sales Office/Distributors for availability and specifications.

Storage Temperature	-65°C to +150°C
Ambient Temperature under Bias	-55°C to +125°C
Junction Temperature under Bias	-55°C to +175°C
Plastic	-55°C to +150°C
V _{CC} Pin Potential to Ground Pin	-0.5V to +7.0V
Input Voltage (Note 2)	-0.5V to +7.0V
Input Current (Note 2)	-30 mA to +5.0 mA
Voltage Applied to Output in HIGH State (with V _{CC} = 0V)	
Standard Output	-0.5V to V _{CC}
TRI-STATE® Output	-0.5V to +5.5V

Current Applied to Output in LOW State (Max) twice the rated I_{OL} (mA)

ESD Last Passing Voltage (Min) 4000V

Note 1: Absolute maximum ratings are values beyond which the device may be damaged or have its useful life impaired. Functional operation under these conditions is not implied.

Note 2: Either voltage limit or current limit is sufficient to protect inputs.

Recommended Operating Conditions

Free Air Ambient Temperature	
Military	-55°C to +125°C
Commercial	0°C to +70°C
Supply Voltage	
Military	+4.5V to +5.5V
Commercial	+4.5V to +5.5V

DC Electrical Characteristics

Symbol	Parameter	54F/74F			Units	V _{CC}	Conditions
		Min	Typ	Max			
V _{IH}	Input HIGH Voltage	2.0			V		Recognized as a HIGH Signal
V _{IL}	Input LOW Voltage			0.8	V		Recognized as a LOW Signal
V _{CD}	Input Clamp Diode Voltage			-1.2	V	Min	I _{IN} = -18 mA
V _{OH}	Output HIGH Voltage	54F 10% V _{CC}	2.5		V	Min	I _{OH} = -1 mA I _{OH} = -1 mA I _{OH} = -1 mA
		74F 10% V _{CC}	2.5				
		74F 5% V _{CC}	2.7				
V _{OL}	Output LOW Voltage	54F 10% V _{CC}		0.5	V	Min	I _{OL} = 20 mA I _{OL} = 20 mA
		74F 10% V _{CC}		0.5			
I _{IH}	Input HIGH Current	54F		20.0	μA	Max	V _{IN} = 2.7V
		74F		5.0			
I _{BVI}	Input HIGH Current Breakdown Test	54F		100	μA	Max	V _{IN} = 7.0V
		74F		7.0			
I _{CEx}	Output HIGH Leakage Current	54F		250	μA	Max	V _{OUT} = V _{CC}
		74F		50			
V _{ID}	Input Leakage Test	74F	4.75		V	0.0	I _{ID} = 1.9 μA All Other Pins Grounded
I _{OD}	Output Leakage Circuit Current	74F		3.75	μA	0.0	V _{IOD} = 150 mV All Other Pins Grounded
I _{IL}	Input LOW Current			-0.6	mA	Max	V _{IN} = 0.5V
I _{OS}	Output Short-Circuit Current		-60	-150	mA	Max	V _{OUT} = 0V
I _{CCCH}	Power Supply Current		10	15	mA	Max	V _O = HIGH
I _{CCCL}	Power Supply Current		15	25	mA	Max	V _O = LOW

AC Electrical Characteristics

Symbol	Parameter	74F			54F		74F		Units
		T _A = +25°C V _{CC} = +5.0V C _L = 50 pF			T _A , V _{CC} = Mil C _L = 50 pF		T _A , V _{CC} = Com C _L = 50 pF		
		Min	Typ	Max	Min	Max	Min	Max	
t _{PLH} t _{PHL}	Propagation Delay S to \bar{Z}_n	3.0	5.5	8.5	3.0	10.5	3.0	9.5	ns
		2.5	4.5	6.5	2.5	8.0	2.5	7.0	
t _{PLH} t _{PHL}	Propagation Delay \bar{E} to \bar{Z}_n	2.5	4.5	6.0	2.5	8.0	2.5	7.0	ns
		2.0	4.0	6.0	2.0	7.0	2.0	6.5	
t _{PLH} t _{PHL}	Propagation Delay I _n to \bar{Z}_n	2.5	4.0	5.9	2.5	8.5	2.5	7.0	ns
		1.5	2.5	4.0	1.0	5.0	1.5	4.5	

Ordering Information

The device number is used to form part of a simplified purchasing code where the package type and temperature range are defined as follows:

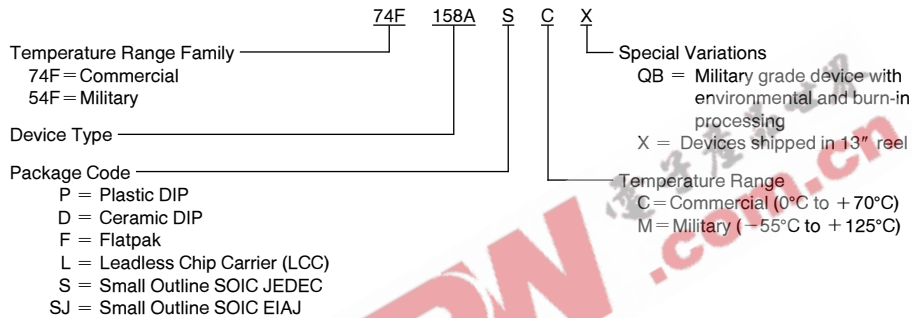

Physical Dimensions inches (millimeters)

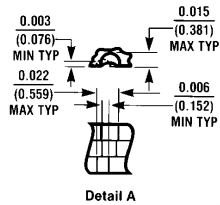
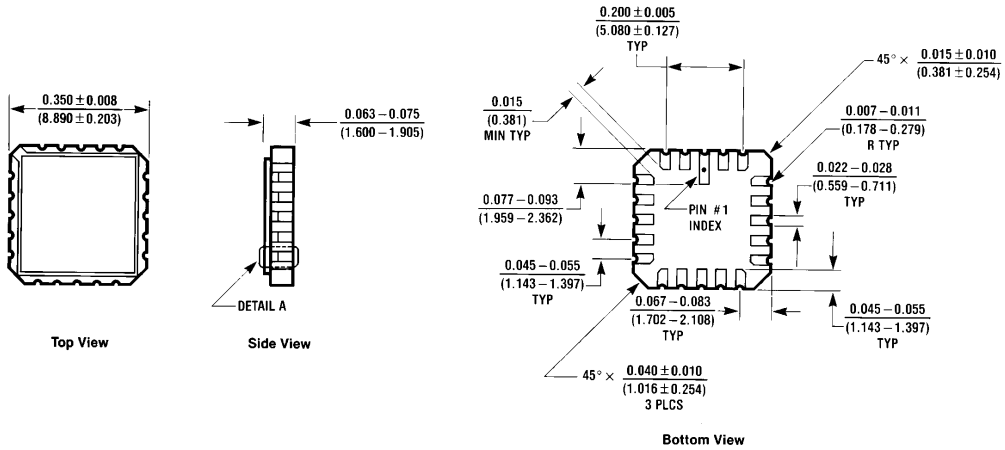

20-Lead Ceramic Leadless Chip Carrier (L)
NS Package Number E20A

E20A (REV D)

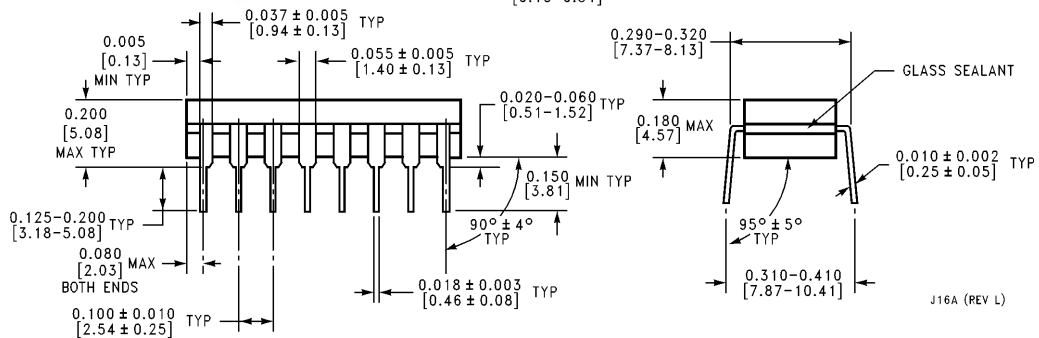
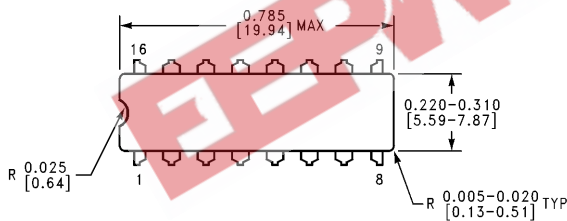

16-Lead Ceramic Dual-In-Line Package (D)
NS Package Number J16A

J16A (REV L)

Physical Dimensions inches (millimeters) (Continued)

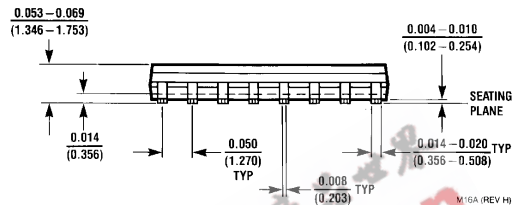
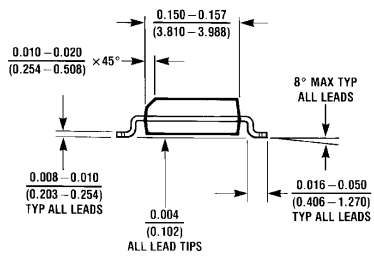
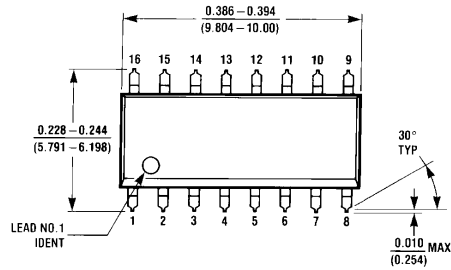

16-Lead (0.150" Wide) Molded Small Outline Package, JEDEC (S)
NS Package Number M16A

EEPW.com.cn

Physical Dimensions inches (millimeters) (Continued)

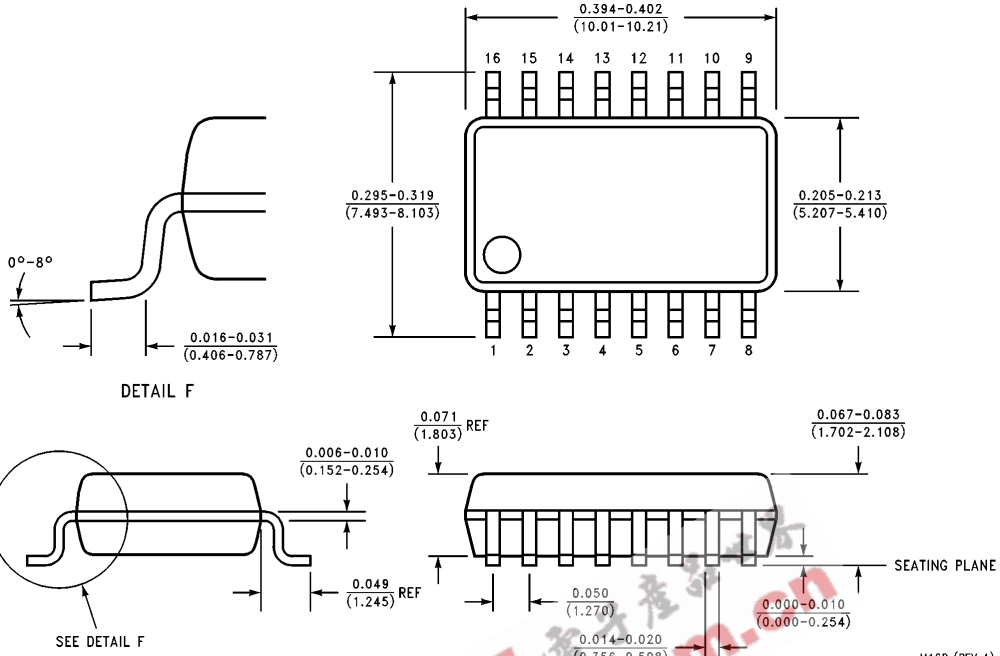

16-Lead (0.300" Wide) Molded Small Outline Package, EIAJ (SJ)
NS Package Number M16D

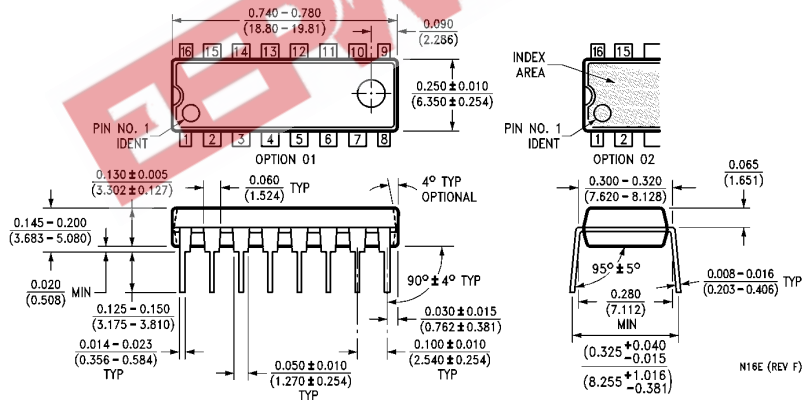

16-Lead (0.300" Wide) Molded Dual-In-Line Package (P)
NS Package Number N16E

Physical Dimensions inches (millimeters) (Continued)

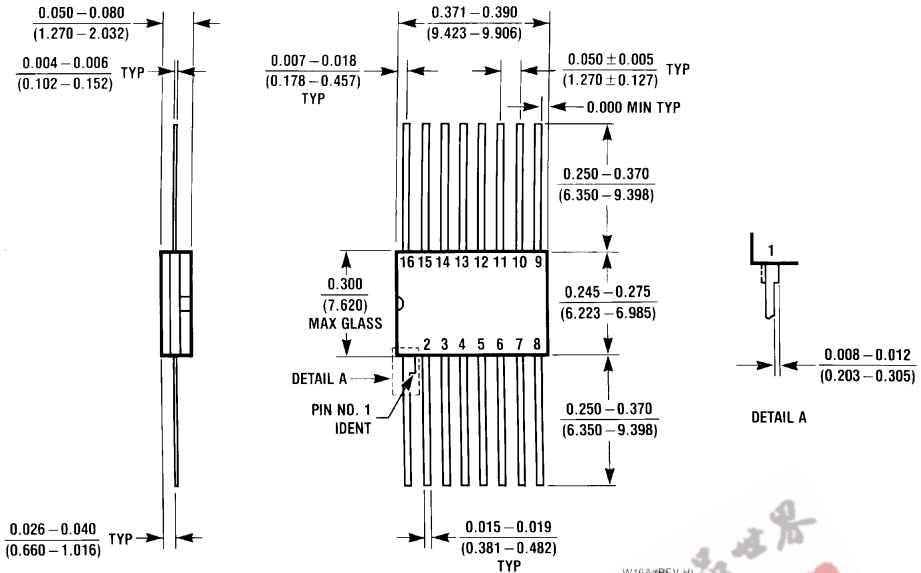

**16-Lead Ceramic Flatpak (F)
NS Package Number W16A**

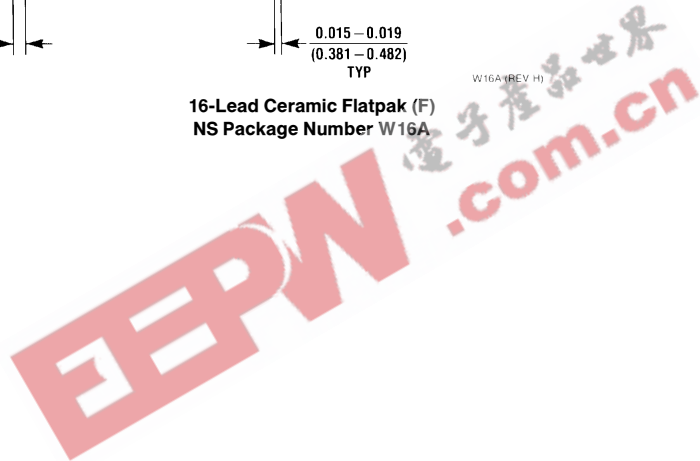

LIFE SUPPORT POLICY

NATIONAL'S PRODUCTS ARE NOT AUTHORIZED FOR USE AS CRITICAL COMPONENTS IN LIFE SUPPORT DEVICES OR SYSTEMS WITHOUT THE EXPRESS WRITTEN APPROVAL OF THE PRESIDENT OF NATIONAL SEMICONDUCTOR CORPORATION. As used herein:

1. Life support devices or systems are devices or systems which, (a) are intended for surgical implant into the body, or (b) support or sustain life, and whose failure to perform, when properly used in accordance with instructions for use provided in the labeling, can be reasonably expected to result in a significant injury to the user.
2. A critical component is any component of a life support device or system whose failure to perform can be reasonably expected to cause the failure of the life support device or system, or to affect its safety or effectiveness.

 <p>National Semiconductor Corporation 2900 Semiconductor Drive P.O. Box 58090 Santa Clara, CA 95052-8090 Tel: 1 (800) 272-9959 TWX: (910) 339-9240</p>	<p>National Semiconductor GmbH Livvy-Gargan-Str. 10 D-82256 Fürstenfeldbruck Germany Tel: (81-41) 35-0 Telex: 527649 Fax: (81-41) 35-1</p>	<p>National Semiconductor Japan Ltd. Sumitomo Chemical Engineering Center Bldg. 7F 1-7-1, Nakase, Mihama-Ku Chiba-City, Chiba Prefecture 261 Tel: (043) 299-2300 Fax: (043) 299-2500</p>	<p>National Semiconductor Hong Kong Ltd. 13th Floor, Straight Block, Ocean Centre, 5 Canton Rd. Tsimshatsui, Kowloon Hong Kong Tel: (852) 2737-1600 Fax: (852) 2736-9960</p>	<p>National Semiconductores Do Brazil Ltda. Rue Deputado Lacorda Franco 120-3A Sao Paulo-SP Brazil 05418-000 Tel: (55-11) 212-5066 Telex: 391-1131931 NSBR BR Fax: (55-11) 212-1181</p>	<p>National Semiconductor (Australia) Pty, Ltd. Building 16 Business Park Drive Monash Business Park Nottingham, Melbourne Victoria 3168 Australia Tel: (3) 558-9889 Fax: (3) 558-9898</p>
---	---	---	---	--	---

National does not assume any responsibility for use of any circuitry described, no circuit patent licenses are implied and National reserves the right at any time without notice to change said circuitry and specifications.