

2.00mm (0.079") PITCH CONNECTOR

Wire-to-Board
Housing

2002HS Series

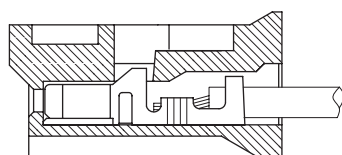
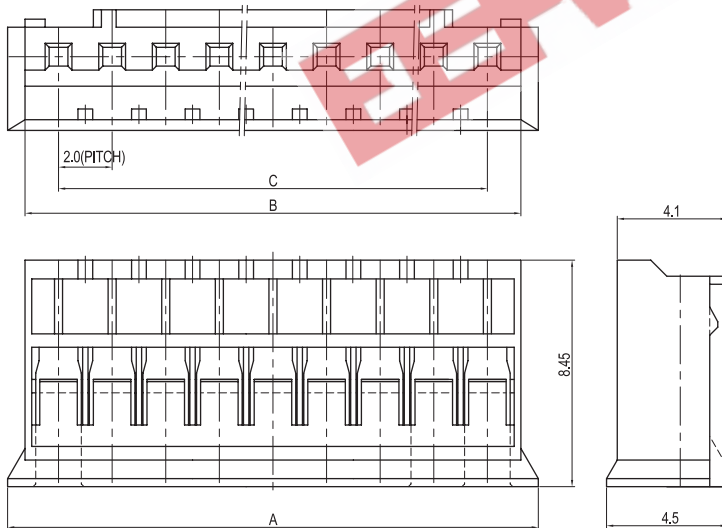
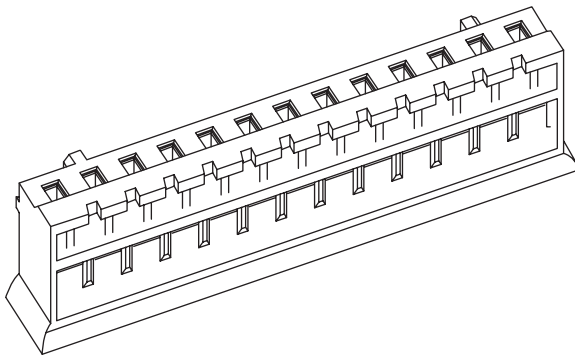

TERMINAL ASSEMBLY DRAWING



AWG : #22 ~ #28

Material

I/NO	DESCRIPTION	TITLE	MATERIAL
1	HOUSING	2002HS	PA66, UL 94V Grade

Available Pin

PARTS NO.	DIM. A	DIM. B	DIM. C
2002HS-02S00	5.80	4.75	2.0
2002HS-03S00	7.80	6.75	4.0
2002HS-04S00	9.80	8.75	6.0
2002HS-05A00	11.80	10.75	8.0
2002HS-06S00	13.80	12.75	10.0
2002HS-07S00	15.80	14.75	12.0
2002HS-08S00	17.80	16.75	14.0
2002HS-09S00	19.80	18.75	16.0
2002HS-10S00	21.80	20.75	18.0
2002HS-11S00	23.80	22.75	20.0
2002HS-12S00	25.80	24.75	22.0
2002HS-13S00	27.80	26.75	24.0
2002HS-14S00	29.80	28.75	26.0
2002HS-15S00	31.80	30.75	28.0

Specification

ITEM	SPEC
Voltage Rating	AC/DC 125V
Current Rating	AC/DC 2A
Operating Temperature	-25°C~+85°C
Contact Resistance	30mΩ MAX
Withstanding Voltage	AC1000V/1min
Insulation Resistance	1000MΩ MIN
Applicable Wire	AWG #22~#28
Applicable P.C.B	-
Applicable FPC/FFC	-
Solder Height	-
Crimp Tensile Strength	-
UL FILE NO	-

Application Terminal : YST200 (83 page)