

# FDM3300NZ

## Monolithic Common Drain N-Channel 2.5V Specified PowerTrench® MOSFET 20V, 10A, 23mΩ

### Features

- Max  $r_{DS(on)}$  = 23mΩ at  $V_{GS} = 4.5V$ ,  $I_D = 10A$
- Max  $r_{DS(on)}$  = 28mΩ at  $V_{GS} = 2.5V$ ,  $I_D = 9A$
- >2000V ESD protection
- Low Profile - 1mm maximum - in the new package MLP 3.3x3.3 mm
- RoHS Compliant



### General Description

This dual N-Channel MOSFET has been designed using Fairchild Semiconductor's advanced PowerTrench® process to optimize the  $r_{DS(on)}$  @  $V_{GS} = 2.5V$  on special MLP lead frame with all the drains on one side of the package.

### Application

- Li-Ion Battery Pack

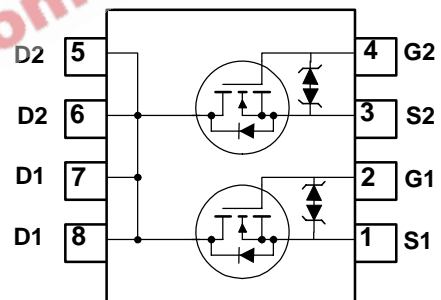
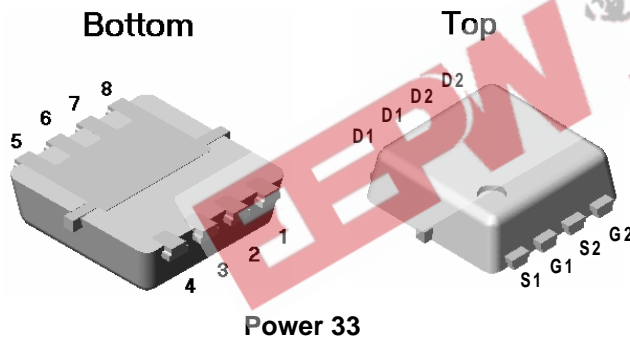

### MOSFET Maximum Ratings $T_A = 25^\circ C$ unless otherwise noted

Symbol	Parameter	Rating	Units
$V_{DS}$	Drain to Source Voltage	20	V
$V_{GS}$	Gate to Source Voltage	±12	V
$I_D$	Drain Current -Continuous	(Note 1a) 10	A
	-Pulsed	40	
$P_D$	Power Dissipation (Steady State)	(Note 1a) 2.1	W
		(Note 1b) 0.9	
$T_J, T_{STG}$	Operating and Storage Junction Temperature Range	-55 to +150	°C

### Thermal Characteristics

$R_{\theta JA}$	Thermal Resistance, Junction to Ambient	(Note 1a) 60	°C/W
$R_{\theta JA}$	Thermal Resistance, Junction to Ambient	(Note 1b) 135	

### Package Marking and Ordering Information

Device Marking	Device	Package	Reel Size	Tape Width	Quantity
3300N	FDM3300NZ	Power 33	7"	8mm	3000 units

### Electrical Characteristics $T_J = 25^\circ\text{C}$ unless otherwise noted

Symbol	Parameter	Test Conditions	Min	Typ	Max	Units
--------	-----------	-----------------	-----	-----	-----	-------

#### Off Characteristics

$BV_{DSS}$	Drain to Source Breakdown Voltage	$I_D = 250\mu\text{A}, V_{GS} = 0\text{V}$	20			V
$\frac{\Delta BV_{DSS}}{\Delta T_J}$	Breakdown Voltage Temperature Coefficient	$I_D = 250\mu\text{A}$ , referenced to $25^\circ\text{C}$		10.7		mV/ $^\circ\text{C}$
$I_{DSS}$	Zero Gate Voltage Drain Current	$V_{DS} = 16\text{V}, V_{GS} = 0\text{V}$			1	$\mu\text{A}$
$I_{GSS}$	Gate to Source Leakage Current	$V_{GS} = \pm 12\text{V}, V_{DS} = 0\text{V}$			$\pm 10$	$\mu\text{A}$

#### On Characteristics

$V_{GS(th)}$	Gate to Source Threshold Voltage	$V_{GS} = V_{DS}, I_D = 250\mu\text{A}$	0.6	0.9	1.5	V
$\frac{\Delta V_{GS(th)}}{\Delta T_J}$	Gate to Source Threshold Voltage Temperature Coefficient	$I_D = 250\mu\text{A}$ , referenced to $25^\circ\text{C}$		-3		mV/ $^\circ\text{C}$
$r_{DS(on)}$	Static Drain to Source On Resistance	$V_{GS} = 4.5\text{V}, I_D = 10\text{A}$		16	23	m $\Omega$
		$V_{GS} = 2.5\text{V}, I_D = 9\text{A}$		20	28	
		$V_{GS} = 4.5\text{V}, I_D = 10\text{A}, T_J = 125^\circ\text{C}$		22	31	
$g_{FS}$	Forward Transconductance	$V_{DS} = 5\text{V}, I_D = 10\text{A}$		35		S

#### Dynamic Characteristics

$C_{iss}$	Input Capacitance	$V_{DS} = 10\text{V}, V_{GS} = 0\text{V}, f = 1\text{MHz}$		1210	1610	pF
$C_{oss}$	Output Capacitance			330	440	pF
$C_{riss}$	Reverse Transfer Capacitance			180	270	pF
$R_g$	Gate Resistance		$f = 1\text{MHz}$	2.3		$\Omega$

#### Switching Characteristics

$t_{d(on)}$	Turn-On Delay Time	$V_{DD} = 10\text{V}, I_D = 1.0\text{A}$ $V_{GS} = 4.5\text{V}, R_{GEN} = 6.0\Omega$		10	20	ns	
$t_r$	Rise Time			14	25	ns	
$t_{d(off)}$	Turn-Off Delay Time			26	42	ns	
$t_f$	Fall Time			13	23	ns	
$Q_g$	Total Gate Charge		$V_{GS} = 4.5\text{V}$		12	17	nC
$Q_{gs}$	Gate to Source Gate Charge		$V_{DD} = 10\text{V}$ $I_D = 10\text{A}$		2		nC
$Q_{gd}$	Gate to Drain "Miller" Charge			4		nC	

#### Drain-Source Diode Characteristics

$V_{SD}$	Source to Drain Diode Forward Voltage	$V_{GS} = 0\text{V}, I_S = 2.0\text{A}$ (Note 2)		0.7	1.2	V
$t_{rr}$	Reverse Recovery Time	$I_F = 10\text{A}, di/dt = 100\text{A}/\mu\text{s}$		20		ns
$Q_{rr}$	Reverse Recovery Charge			6		nC

#### Notes:

1:  $R_{\theta JA}$  is determined with the device mounted on a 1 in<sup>2</sup> oz copper pad on a 1.5 x 1.5 in. board of FR-4 material.  $R_{\theta JC}$  is guaranteed by design while  $R_{\theta JA}$  is determined by the user's board design.

(a)  $R_{\theta JA} = 60^\circ\text{C}/\text{W}$  when mounted on a 1 in<sup>2</sup> pad of 2 oz copper, 1.5'x1.5'x0.062' thick PCB.

(b)  $R_{\theta JA} = 135^\circ\text{C}/\text{W}$  when mounted on a minimum pad of 2 oz copper.

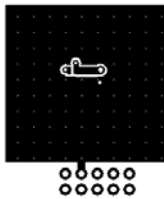

a.  $60^\circ\text{C}/\text{W}$  when mounted on a 1 in<sup>2</sup> pad of 2 oz copper



b.  $135^\circ\text{C}/\text{W}$  when mounted on a minimum pad of 2 oz copper

2: Pulse Test: Pulse Width < 300 $\mu\text{s}$ , Duty cycle < 2.0%.

**Typical Characteristics**  $T_J = 25^\circ\text{C}$  unless otherwise noted

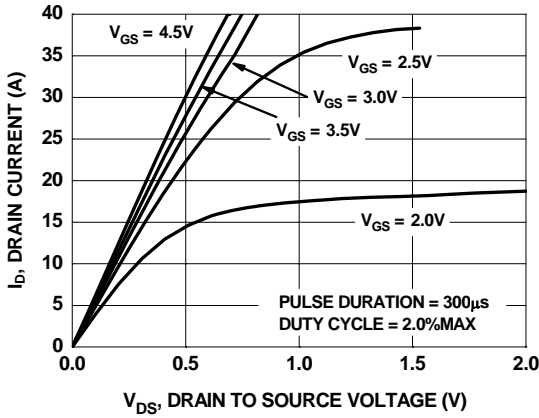

Figure 1. On Region Characteristics

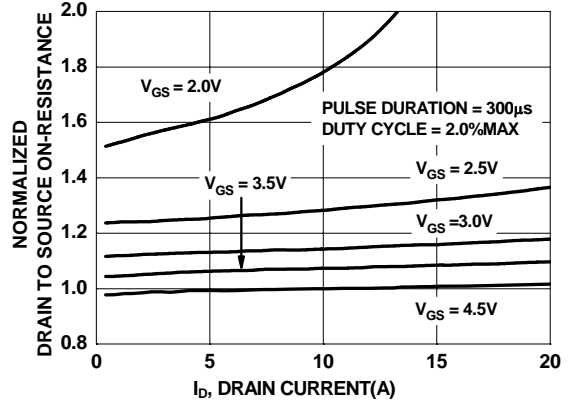

Figure 2. Normalized On-Resistance vs Drain Current and Gate Voltage

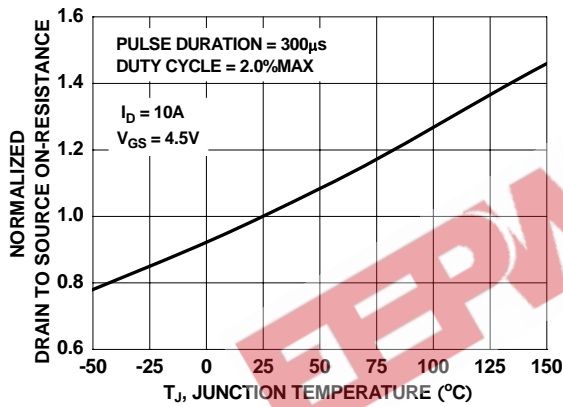

Figure 3. Normalized On Resistance vs Junction Temperature

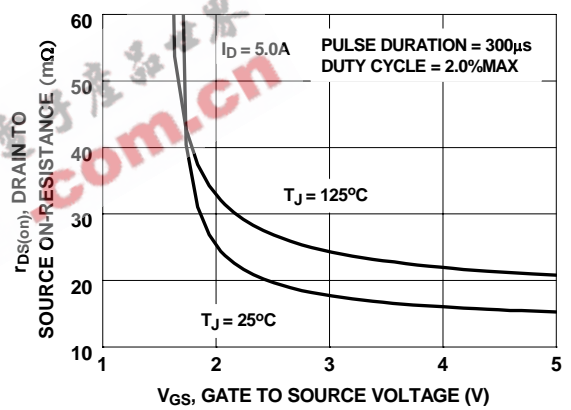

Figure 4. On-Resistance vs Gate to Source Voltage

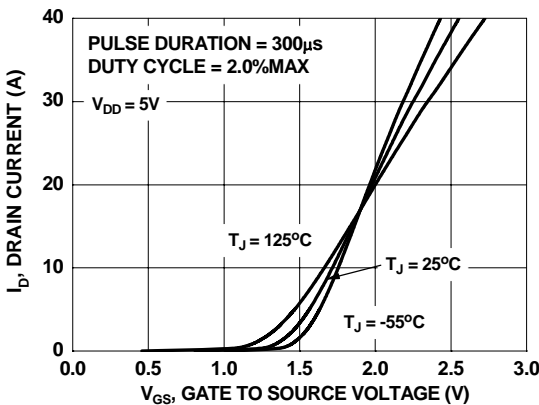

Figure 5. Transfer Characteristics

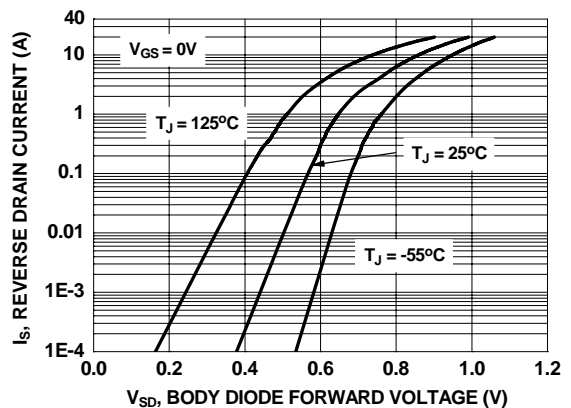
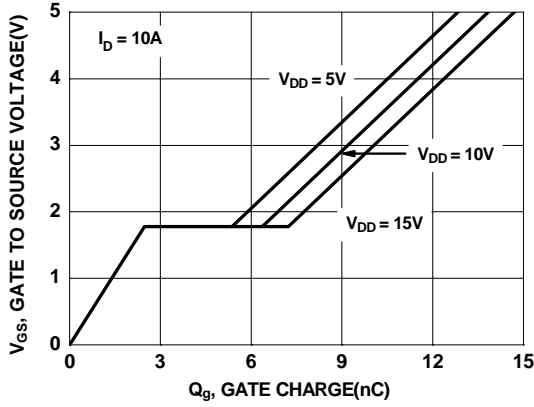
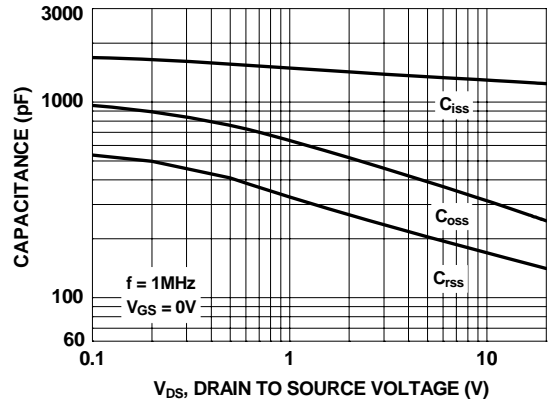

Figure 6. Source to Drain Diode Forward Voltage vs Source Current

**Typical Characteristics**  $T_J = 25^\circ\text{C}$  unless otherwise noted



**Figure 7. Gate Charge Characteristics**



**Figure 8. Capacitance vs Drain to Source Voltage**

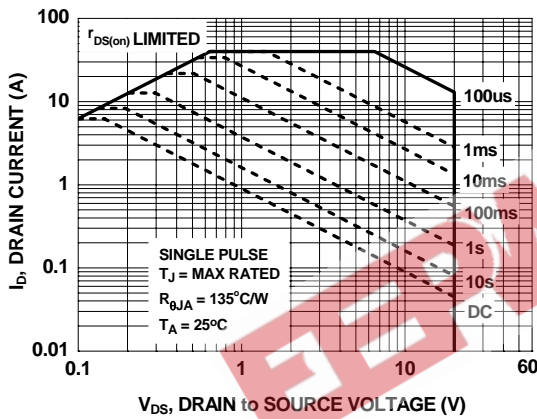

**Figure 9. Forward Bias Safe Operating Area**

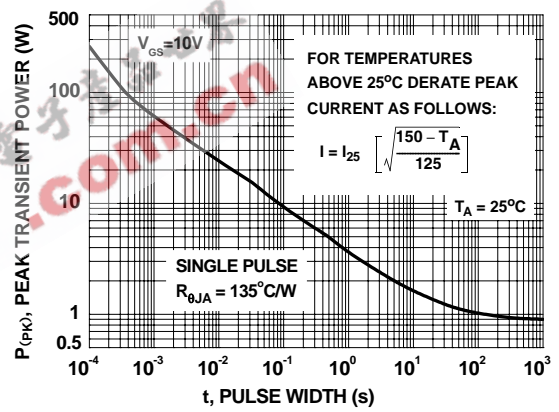

**Figure 10. Single Pulse Maximum Power Dissipation**

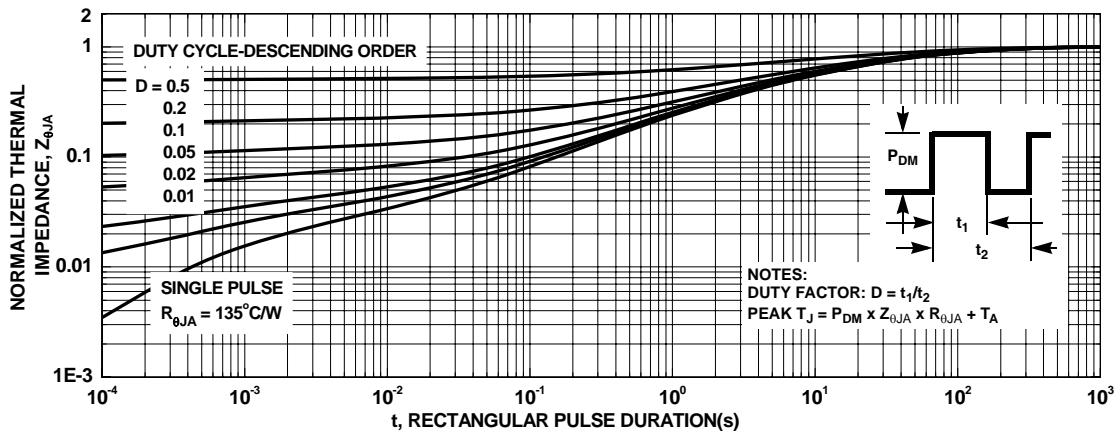

**Figure 11. Transient Thermal Response Curve**

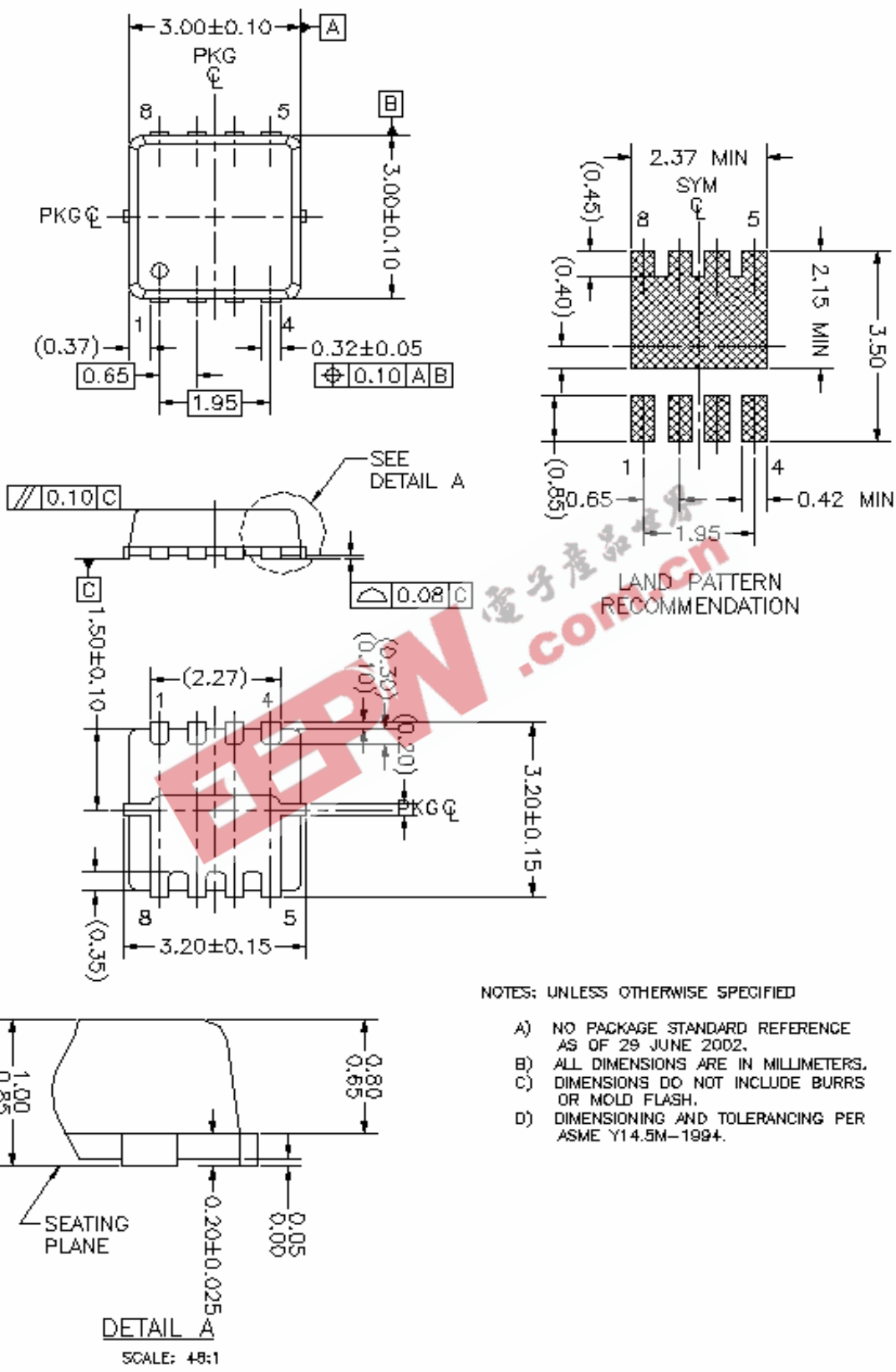

- NOTES: UNLESS OTHERWISE SPECIFIED
- A) NO PACKAGE STANDARD REFERENCE AS OF 29 JUNE 2002.
  - B) ALL DIMENSIONS ARE IN MILLIMETERS.
  - C) DIMENSIONS DO NOT INCLUDE BURRS OR MOLD FLASH.
  - D) DIMENSIONING AND TOLERANCING PER ASME Y14.5M-1994.

## TRADEMARKS

The following are registered and unregistered trademarks Fairchild Semiconductor owns or is authorized to use and is not intended to be an exhaustive list of all such trademarks.

ACE <sup>™</sup>	FACT Quiet Series <sup>™</sup>	OCX <sup>™</sup>	SILENT SWITCHER <sup>®</sup>	UniFET <sup>™</sup>
ActiveArray <sup>™</sup>	GlobalOptoisolator <sup>™</sup>	OCXPro <sup>™</sup>	SMART START <sup>™</sup>	VCX <sup>™</sup>
Bottomless <sup>™</sup>	GTO <sup>™</sup>	OPTOLOGIC <sup>®</sup>	SPM <sup>™</sup>	Wire <sup>™</sup>
Build it Now <sup>™</sup>	HiSeC <sup>™</sup>	OPTOPLANAR <sup>™</sup>	Stealth <sup>™</sup>	
CoolFET <sup>™</sup>	I <sup>2</sup> C <sup>™</sup>	PACMAN <sup>™</sup>	SuperFET <sup>™</sup>	
CROSSVOLT <sup>™</sup>	<i>i-Lo</i> <sup>™</sup>	POP <sup>™</sup>	SuperSOT <sup>™</sup> -3	
DOME <sup>™</sup>	ImpliedDisconnect <sup>™</sup>	Power247 <sup>™</sup>	SuperSOT <sup>™</sup> -6	
EcoSPARK <sup>™</sup>	IntelliMAX <sup>™</sup>	PowerEdge <sup>™</sup>	SuperSOT <sup>™</sup> -8	
E <sup>2</sup> CMOS <sup>™</sup>	ISOPLANAR <sup>™</sup>	PowerSaver <sup>™</sup>	SyncFET <sup>™</sup>	
EnSigna <sup>™</sup>	LittleFET <sup>™</sup>	PowerTrench <sup>®</sup>	TCM <sup>™</sup>	
FACT <sup>®</sup>	MICROCOUPLER <sup>™</sup>	QFET <sup>®</sup>	TinyBoost <sup>™</sup>	
FAST <sup>®</sup>	MicroFET <sup>™</sup>	QST <sup>™</sup>	TinyBuck <sup>™</sup>	
FAST <sup>r</sup> <sup>™</sup>	MicroPak <sup>™</sup>	QT Optoelectronics <sup>™</sup>	TinyPWM <sup>™</sup>	
FPS <sup>™</sup>	MICROWIRE <sup>™</sup>	Quiet Series <sup>™</sup>	TinyPower <sup>™</sup>	
FRFET <sup>™</sup>	MSX <sup>™</sup>	RapidConfigure <sup>™</sup>	TinyLogic <sup>®</sup>	
	MSXPro <sup>™</sup>	RapidConnect <sup>™</sup>	TINYOPTO <sup>™</sup>	
		μSerDes <sup>™</sup>	TruTranslation <sup>™</sup>	
		ScalarPump <sup>™</sup>	UHC <sup>®</sup>	
Across the board. Around the world. <sup>™</sup>				
The Power Franchise <sup>®</sup>				
Programmable Active Droop <sup>™</sup>				

## DISCLAIMER

FAIRCHILD SEMICONDUCTOR RESERVES THE RIGHT TO MAKE CHANGES WITHOUT FURTHER NOTICE TO ANY PRODUCTS HEREIN TO IMPROVE RELIABILITY, FUNCTION OR DESIGN. FAIRCHILD DOES NOT ASSUME ANY LIABILITY ARISING OUT OF THE APPLICATION OR USE OF ANY PRODUCT OR CIRCUIT DESCRIBED HEREIN; NEITHER DOES IT CONVEY ANY LICENSE UNDER ITS PATENT RIGHTS, NOR THE RIGHTS OF OTHERS. THESE SPECIFICATIONS DO NOT EXPAND THE TERMS OF FAIRCHILD'S WORLDWIDE TERMS AND CONDITIONS, SPECIFICALLY THE WARRANTY THEREIN, WHICH COVERS THESE PRODUCTS.

## LIFE SUPPORT POLICY

FAIRCHILD'S PRODUCTS ARE NOT AUTHORIZED FOR USE AS CRITICAL COMPONENTS IN LIFE SUPPORT DEVICES OR SYSTEMS WITHOUT THE EXPRESS WRITTEN APPROVAL OF FAIRCHILD SEMICONDUCTOR CORPORATION.

As used herein:

- Life support devices or systems are devices or systems which, (a) are intended for surgical implant into the body, or (b) support or sustain life, or (c) whose failure to perform when properly used in accordance with instructions for use provided in the labeling, can be reasonably expected to result in significant injury to the user.
- A critical component is any component of a life support device or system whose failure to perform can be reasonably expected to cause the failure of the life support device or system, or to affect its safety or effectiveness.

## PRODUCT STATUS DEFINITIONS

### Definition of Terms

Datasheet Identification	Product Status	Definition
Advance Information	Formative or In Design	This datasheet contains the design specifications for product development. Specifications may change in any manner without notice.
Preliminary	First Production	This datasheet contains preliminary data, and supplementary data will be published at a later date. Fairchild Semiconductor reserves the right to make changes at any time without notice in order to improve design.
No Identification Needed	Full Production	This datasheet contains final specifications. Fairchild Semiconductor reserves the right to make changes at any time without notice in order to improve design.
Obsolete	Not In Production	This datasheet contains specifications on a product that has been discontinued by Fairchild semiconductor. The datasheet is printed for reference information only.

Rev. I22