

CS1009

2.5 Volt Reference

The CS1009 is a precision trimmed 2.5 V ± 5.0 mV shunt regulator diode. The low dynamic impedance and wide operating current range enhances its versatility. The tight reference tolerance is achieved by on-chip trimming which minimizes voltage tolerance and temperature drift.

A third terminal allows the reference voltage to be adjusted $\pm 5.0\%$ to calibrate out system errors. In many applications, the CS1009GZ can be used as a pin-to-pin replacement of the LT1009CZ and the LM136Z-2.5 with the external trim network eliminated.

Features

- 0.2% Initial Tolerance Max.
- Guaranteed Temperature Stability
- Maximum 0.6 Ω Dynamic Impedance
- Wide Operating Current Range
- Directly Interchangeable with LT1009 and LM136 for Improved Performance
- No Adjustments Needed for Minimum Temperature Coefficient
- Meets Mil Std 883C ESD Requirements

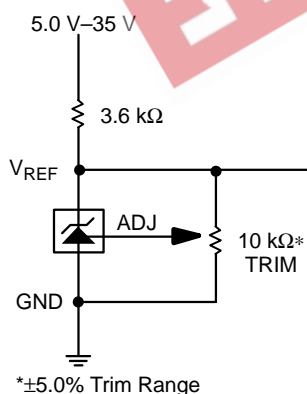

Figure 1. Application Diagram



ON Semiconductor™

<http://onsemi.com>



SO-8
D SUFFIX
CASE 751



TO-92
Z SUFFIX
CASE 29

PIN CONNECTIONS AND MARKING DIAGRAM

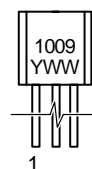
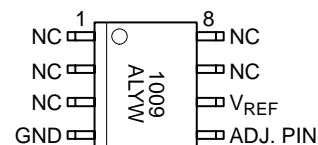

Pin 1. ADJ. PIN
2. VREF
3. GND

A = Assembly Location
WL, L = Wafer Lot
YY, Y = Year
WW, W = Work Week

ORDERING INFORMATION

Device	Package	Shipping
CS1009GD8	SO-8	95 Units/Rail
CS1009GDR8	SO-8	2500 Tape & Reel
CS1009GZ3	TO-92	2000 Units
CS1009GZR3	TO-92	2000 Tape & Reel

CS1009

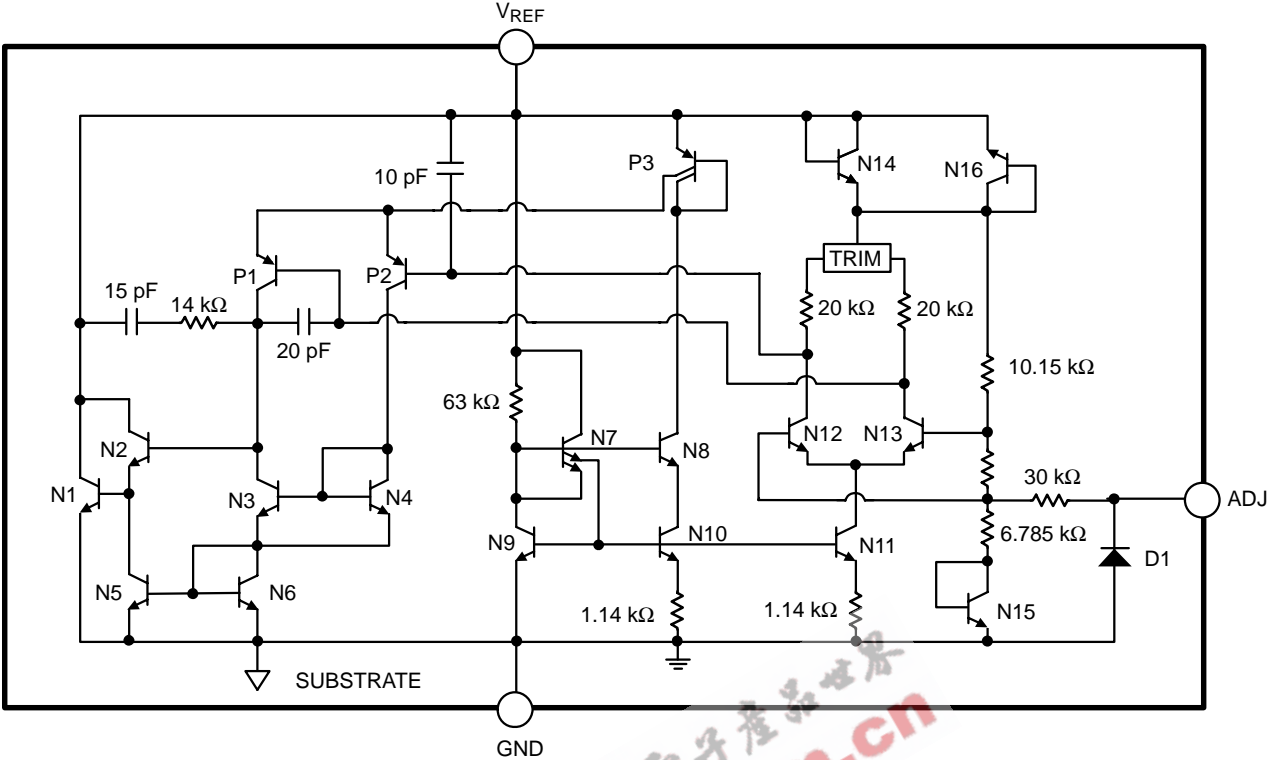
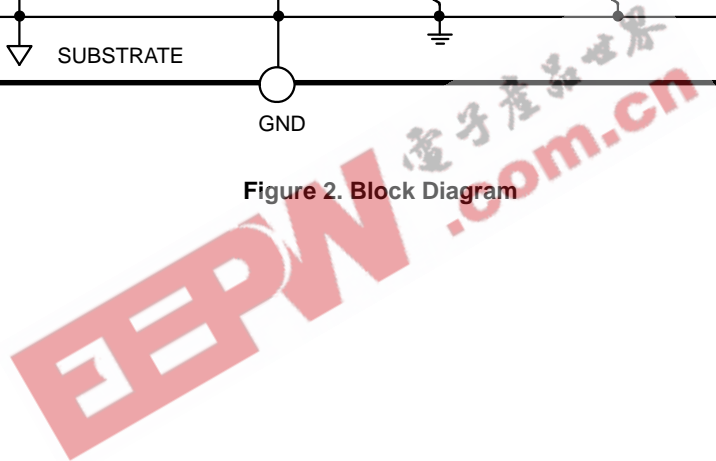

Figure 2. Block Diagram



CS1009

MAXIMUM RATINGS*

Rating	Value	Unit	
Reverse Current	20	mA	
Forward	10	mA	
Operating Temperature Range	-40 to 105	°C	
Storage Temperature Range	-65 to +150	°C	
Lead Temperature Soldering:	Wave Solder (through hole styles only) (Note 1) Reflow: (SMD styles only) (Note 2)	260 peak 230 peak	°C °C

- 10 second maximum
- 60 second maximum above 183°C.

*The maximum package power dissipation must be observed.

ELECTRICAL CHARACTERISTICS (T_A = 25°C unless otherwise specified.)

Characteristic	Test Conditions	Min	Typ	Max	Unit
Reverse Breakdown Voltage	I _R = 1.0 mA	2.492	2.500	2.508	V
Reverse Breakdown Voltage	0°C ≤ T _A ≤ 105°C	2.492	2.500	2.508	V
Reverse Breakdown Voltage	-40°C ≤ T _A ≤ °C	2.480	2.500	2.508	V
Reverse Breakdown Voltage Change with Current	400 μA ≤ I _R ≤ 10 mA	-	2.6 3.0	10 12	mV mV
Reverse Dynamic Impedance	I _R = 1.0 mA	-	0.2 0.4	1.0 1.4	Ω Ω
Temperature Stability Average Temperature Coefficient	0°C ≤ T _A ≤ 70°C, Note 3 0°C ≤ T _A ≤ 70°C, Note 3	-	-	-	mV ppm/°C
Long Term Stability	T _A = 25°C ± 0.1°C, I _R = 1.0 mA	-	20	-	ppm/kHr

† Denotes the specifications which apply over full operating temperature range.

- Average temperature coefficient is defined as the total voltage change divided by the specified temperature range.

TYPICAL PERFORMANCE CHARACTERISTICS

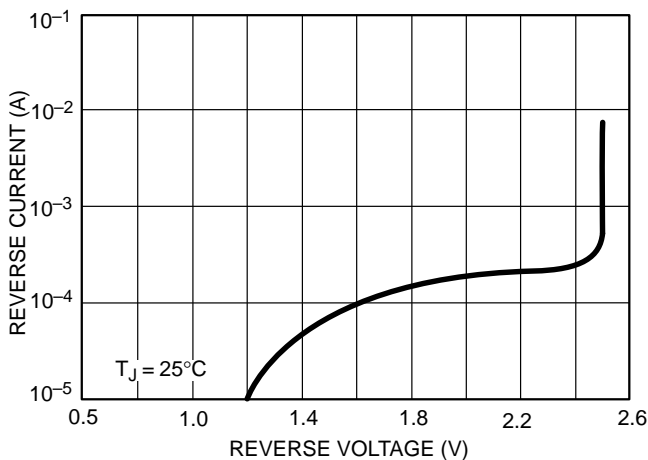

Figure 3. Reverse Current vs. Reverse Voltage

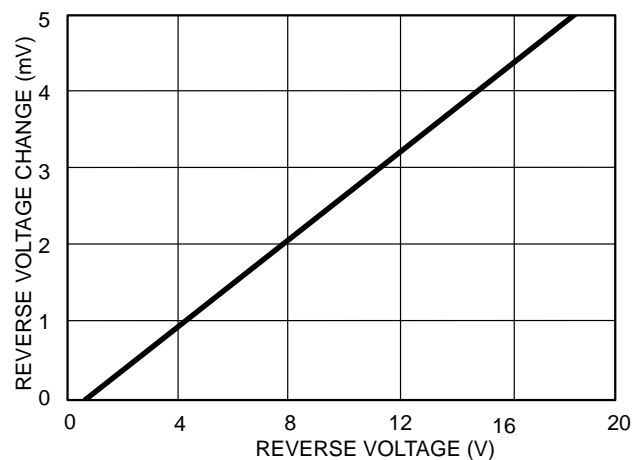

Figure 4. Change in Reverse Voltage vs. Reverse Current

CS1009

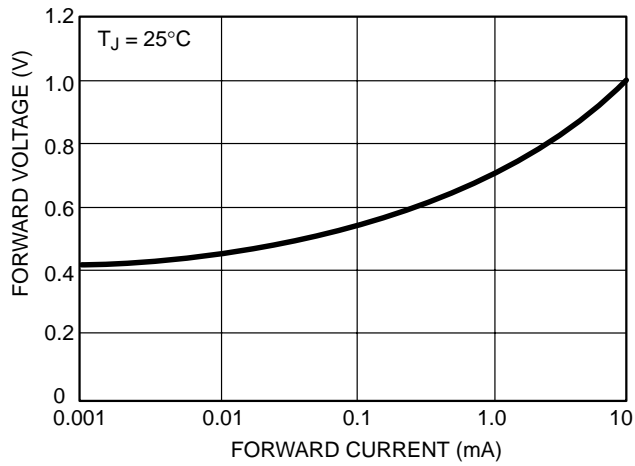

Figure 5. Forward Voltage vs. Forward Current

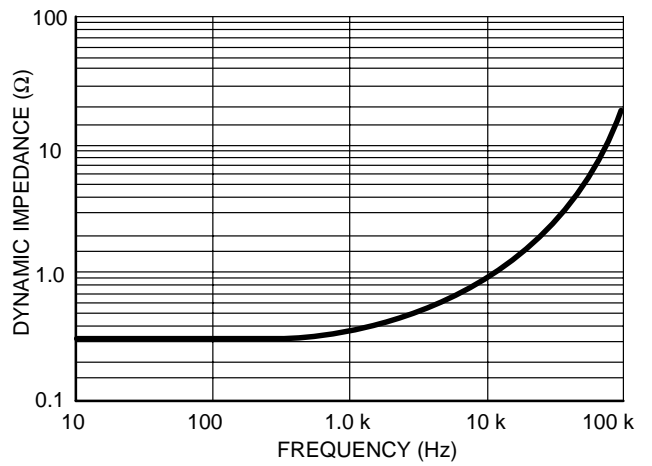

Figure 6. Dynamic Impedance vs. Frequency

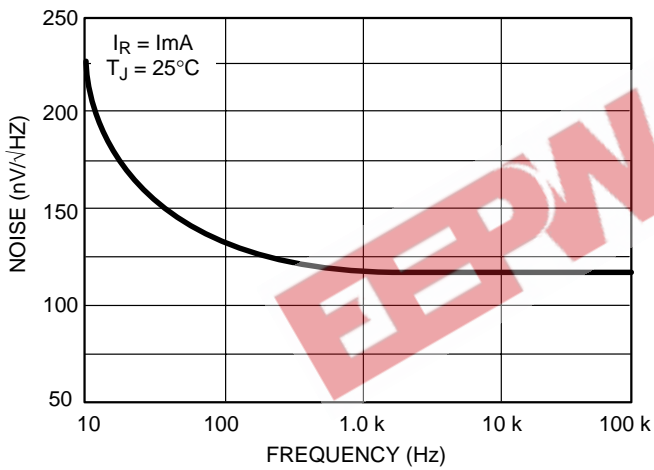

Figure 7. Zener Noise Voltage vs. Frequency

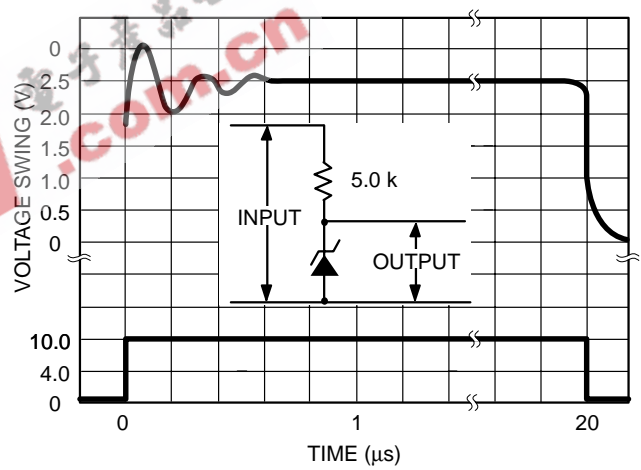

Figure 8. Response Time

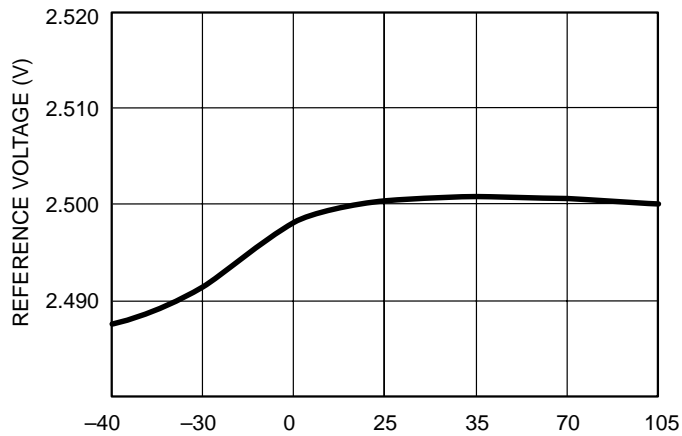
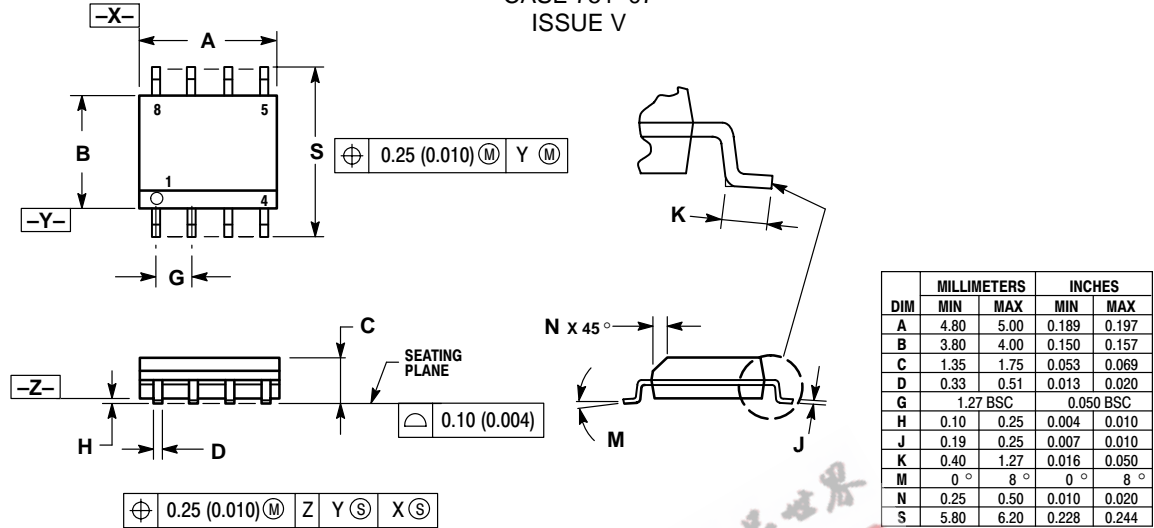

Figure 9. Reference Voltage vs. Temperature

CS1009

PACKAGE DIMENSIONS

SO-8
D SUFFIX
CASE 751-07
ISSUE V



TO-92
Z SUFFIX
CASE 29-11
ISSUE AL

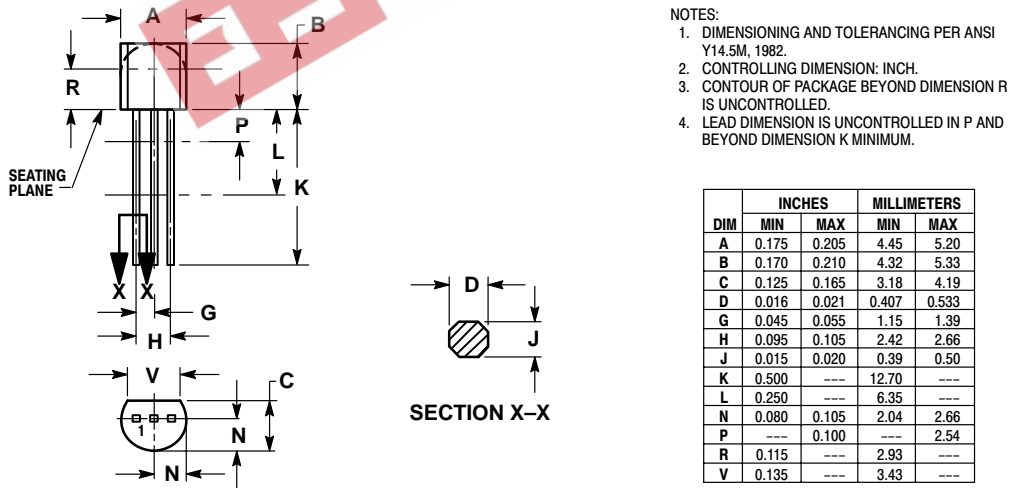

PACKAGE THERMAL DATA

Parameter		SO-8	TO-92	Unit
R _{θJC}	Typical	45	—	°C/W
R _{θJA}	Typical	165	170	°C/W

Notes

EEPW 电子产品世界
.com.cn

Notes

EEPW 电子产品世界
.com.cn

EEPW 电子產品世界
.com.cn

ON Semiconductor and  are trademarks of Semiconductor Components Industries, LLC (SCILLC). SCILLC reserves the right to make changes without further notice to any products herein. SCILLC makes no warranty, representation or guarantee regarding the suitability of its products for any particular purpose, nor does SCILLC assume any liability arising out of the application or use of any product or circuit, and specifically disclaims any and all liability, including without limitation special, consequential or incidental damages. "Typical" parameters which may be provided in SCILLC data sheets and/or specifications can and do vary in different applications and actual performance may vary over time. All operating parameters, including "Typicals" must be validated for each customer application by customer's technical experts. SCILLC does not convey any license under its patent rights nor the rights of others. SCILLC products are not designed, intended, or authorized for use as components in systems intended for surgical implant into the body, or other applications intended to support or sustain life, or for any other application in which the failure of the SCILLC product could create a situation where personal injury or death may occur. Should Buyer purchase or use SCILLC products for any such unintended or unauthorized application, Buyer shall indemnify and hold SCILLC and its officers, employees, subsidiaries, affiliates, and distributors harmless against all claims, costs, damages, and expenses, and reasonable attorney fees arising out of, directly or indirectly, any claim of personal injury or death associated with such unintended or unauthorized use, even if such claim alleges that SCILLC was negligent regarding the design or manufacture of the part. SCILLC is an Equal Opportunity/Affirmative Action Employer.

PUBLICATION ORDERING INFORMATION

Literature Fulfillment:

Literature Distribution Center for ON Semiconductor
P.O. Box 5163, Denver, Colorado 80217 USA
Phone: 303-675-2175 or 800-344-3860 Toll Free USA/Canada
Fax: 303-675-2176 or 800-344-3867 Toll Free USA/Canada
Email: ONlit@hibbertco.com

N. American Technical Support: 800-282-9855 Toll Free USA/Canada

JAPAN: ON Semiconductor, Japan Customer Focus Center
4-32-1 Nishi-Gotanda, Shinagawa-ku, Tokyo, Japan 141-0031
Phone: 81-3-5740-2700
Email: r14525@onsemi.com

ON Semiconductor Website: <http://onsemi.com>

For additional information, please contact your local Sales Representative.