

5-Channel 2-LD Driver for Optical Disc Drive

Preliminary

Description

The CXA2697ER is a laser driver IC corresponded to DVD ×12 and capable of driving two high output lasers (CD/DVD) for writable optical discs.

Features

- CD write channel maximum drive current: 300mA
($V_{CC} = 3V$, $V_{CC_LD} = 4.5V$, $VOP = 2.5V$)
- CD total maximum drive current: 370mA
($V_{CC} = 3.3V$, $V_{CC_LD} = 5V$, $VOP = 2.5V$)
- DVD write channel maximum drive current: 270mA
($V_{CC} = 3V$, $V_{CC_LD} = 4.5V$, $VOP = 3V$)
- DVD total maximum drive current: 360mA
($V_{CC} = 3.3V$, $V_{CC_LD} = 5V$, $VOP = 3V$)
- Capable of generating five-value recording waveform through control of five channels
- Rise/Fall times = 1ns
- Read Channel: ×125
- Write Channel: ×470
- Read Channel has extensive low-noise design
 $1.5nA/\sqrt{Hz}$ (@20MHz, $I_{LD} = 35mA$, $I_{mod} = 20mA_{p-p}$)
- High frequency modulator circuit
- Frequency variable range: 200 to 600MHz
- Modulator amplitude can be set separately for CD and DVD.
- DVD modulator amplitude switching function
- Timing input for generating recording waveform can be adapted to both differential input (LVDS) and single-end input (3.3V CMOS/TTL).

Applications

CD-R, CD-RW, DVD-R, DVD-RW, DVD+R/RW, DVD-ROM and DVD-RAM for high-speed writable optical disc drives

Structure

Bi-CMOS IC

32 pin VQFN (Plastic)

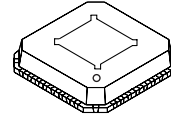
**Absolute Maximum Ratings**

• Supply voltage	V_{CC}	3.6	V
	V_{CC_LD}	5.5	V
• Storage temperature	T_{stg}	-65 to +150	°C
• Allowable power dissipation	P_D	TBD	mW

Operating Conditions

• Supply voltage	V_{CC}	3 to 3.6	V
	V_{CC_LD}	4.5 to 5.5	V
• Operating temperature	T_{opr}	-10 to +75	°C

Sony reserves the right to change products and specifications without prior notice. This information does not convey any license by any implication or otherwise under any patents or other right. Application circuits shown, if any, are typical examples illustrating the operation of the devices. Sony cannot assume responsibility for any problems arising out of the use of these circuits.

Block Diagram and Pin Configuration

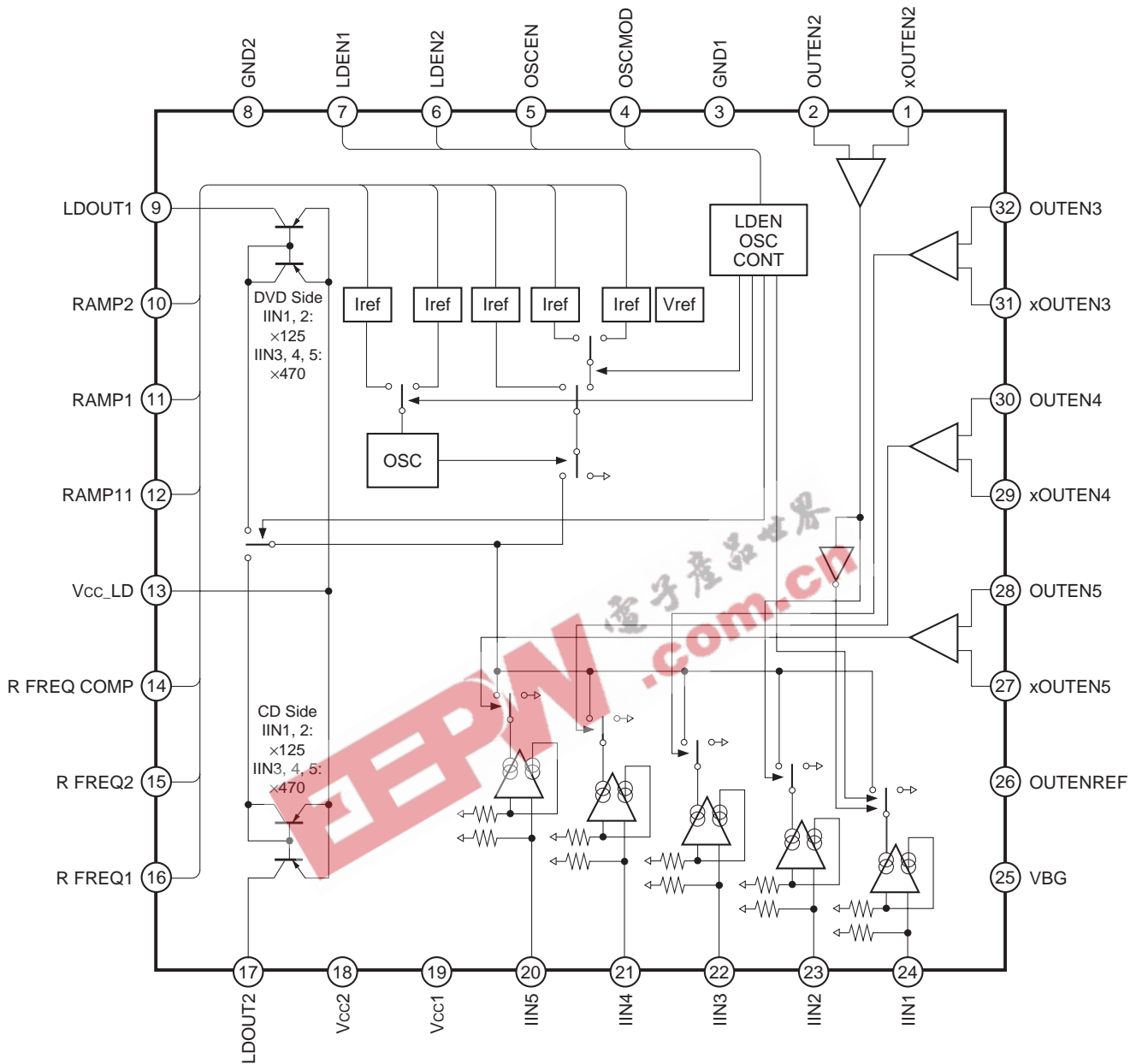

Pin Description

Pin No.	Symbol	I/O	Pin voltage	Equivalent circuit	Description
1	xOUTEN2	I	—		IIN1 or IIN2 set current control signal input.
2	OUTEN2	I	—		IIN1 or IIN2 set current control signal input.
27	xOUTEN5	I	—		IIN5 set current control signal input. (negative logic)
28	OUTEN5	I	—		IIN5 set current control signal input. (positive logic)
29	xOUTEN4	I	—		IIN4 set current control signal input. (negative logic)
30	OUTEN4	I	—		IIN4 set current control signal input. (positive logic)
31	xOUTEN3	I	—		IIN3 set current control signal input. (negative logic)
32	OUTEN3	I	—		IIN3 set current control signal input. (positive logic)
3	GND1	—	—	—	Ground.
4	OSCMOD	I	—		DVD modulator amplitude switching control signal. When OSCMOD = high, RAMP1 is selected. When OSCMOD = low, RAMP11 is selected.
5	OSCEN	I	—		Modulator control signal. (positive logic) When OSCEN = high, the modulator waveform is output.
6	LDEN2	I	—		CD output control. (positive logic)
7	LDEN1	I	—		DVD output control. (positive logic)
8	GND2	—	—	—	Ground.
9	LDOUT1	O	—		DVD laser drive current output. Enabled when LDEN 1 = high and LDEN2 = low.

Pin No.	Symbol	I/O	Pin voltage	Equivalent circuit	Description
10	RAMP2	O	—		Modulator amplitude setting 2. Enabled when LDEN1 = low and LDEN2 = high. Connects resistance to ground.
11	RAMP1	O	—		Modulator amplitude setting 1. Enabled when LDEN1 = high, LDEN2 = low and OSCMOD = high. Connects resistance to ground.
12	RAMP11	O	—		Modulator amplitude setting 11. Enabled when LDEN1 = high, LDEN2 = low and OSCMOD = low. Connects resistance to ground.
13	Vcc_LD	—	—	—	Output stage supply voltage.
14	R FREQ COMP	O	—		Modulator frequency variation adjustment. Connects resistance to ground.
15	R FREQ2	O	—		Modulator frequency setting 2. Enabled when LDEN1 = low and LDEN2 = high. Connects resistance to ground.
16	R FREQ1	O	—		Modulator frequency setting 1. Enabled when LDEN1 = high and LDEN2 = low. Connects resistance to ground.
17	LDOUT2	O	—		CD laser drive current output. Enabled when LDEN1 = low and LDEN2 = high.
18	Vcc2	I	—	—	Supply voltage for timing system and current switch.
19	Vcc1	I	—	—	Supply voltage for control system and modulator system.
20	IIN5	I	—		Current setting 5.
21	IIN4	I	—		Current setting 4.
22	IIN3	I	—		Current setting 3.

Pin No.	Symbol	I/O	Pin voltage	Equivalent circuit	Description
23	IIN2	I	—		Current setting 2.
24	IIN1	I	—		Current setting 1.
25	VBG	O	1.26V		Internal reference voltage decoupling.
26	OUTENREF	O	$1/2V_{CC}$		Reference voltage output for current control signal. Connects decoupling capacitance to ground.

Electrical Characteristics

(V_{CC} = 3.3V, V_{CC_LD} = 5V, T_a = 25°C)

Test No.	Measurement item	Symbol	Min.	Typ.	Max.	Unit	Conditions
1	Current consumption 1	I _{CC1}	1.4	2	2.6	mA	LDEN1, 2 = L
2	Current consumption 1'	I _{CC1'}	23	34	45	mA	(LDEN1 = H, LDEN2 = L) or (LDEN1 = L, LDEN2 = H)
3	Current consumption 2	I _{CC2}	75	110	145	mA	LDEN1 = H, IOUT1 = 60mA, OSCEN = H, AMP = 20mAp-p
4	Current consumption 3	I _{CC3}	162	236	310	mA	LDEN = H, IOUT1 = 60mA, IOUT3 = 240mA (Duty = 25%), IOUT4 = 120mA (Duty = 50%), IOUT = IOUT1 + IOUT3 + IOUT4
5	Current consumption 3-1	I _{CC3_1}	140	200	260	mA	LDEN = H, IOUT1 = 30mA, IOUT3 = 240mA (Duty = 25%), IOUT4 = 120mA (Duty = 50%), IOUT = IOUT1 + IOUT3 + IOUT4
<Logic input block: During single-end transfer>							
6	Input voltage high level	V _{SH}	2	—	V _{CC}	V	
7	Input voltage low level	V _{SL}	GND	—	1.3	V	
<Logic input block: During differential input>							
8	LVDS Input voltage high level	V _{DH}	0.2	—	2.6	V	
9	LVDS Input voltage low level	V _{DL}	0	—	1.6	V	
10	LVDS Input voltage amplitude	V _{PP}	0.2	—	1	V	
<LD driver block: DC>							
11	LD drive current 1, 2	I _{OUTR}	120	—	—	mA	
12	LD drive current 3, 4, 5 (DVD)	I _{OUTW1}	270	—	—	mA	
13	LD drive current 3, 4, 5 (CD)	I _{OUTW2}	300	—	—	mA	
14	Total LD drive current 1 (DVD)	I _{OUT1}	360	—	—	mA	V _{CC} = 3.3V, V _{CC_LD} = 5V, V _{OP} = 3V
15	Total LD drive current 2 (CD)	I _{OUT2}	370	—	—	mA	V _{CC} = 3.3V, V _{CC_LD} = 5V, V _{OP} = 2.5V
16	Minimum LD drive current 1 (DVD)	OFFSET1	—	—	5	mA	I _{IN} = 0μA, LDEN1 = OUTEN2 = OUTEN3 = OUTEN4 = OUTEN5 = H
17	Minimum LD drive current 2 (CD)	OFFSET2	—	—	5	mA	I _{IN} = 0μA, LDEN2 = OUTEN2 = OUTEN3 = OUTEN4 = OUTEN5 = H
18	Output current noise 1	NOISE1	—	1.5	—	nA/√Hz	f = 400MHz, I _{LD} = 35mA, I _{mod} = 20mAp-p (20MHz: NOISE)
19	Output current noise 2	NOISE2	—	1.5	—	nA/√Hz	f = 400MHz, I _{LD} = 35mA, I _{mod} = 40mAp-p (20MHz: NOISE)

Test No.	Measurement item	Symbol	Min.	Typ.	Max.	Unit	Conditions
<LD driver block: Pulse driving>							
20	Propagation delay	DELAY	—	3	—	ns	
21	Rise time (Tr)	TR	—	1	—	ns	ILD = 50 to 100mA pulse Settling 10 to 90% (resistance load)
22	Fall time (Tf)	TF	—	1	—	ns	ILD = 100 to 50mA pulse Settling 10 to 90% (resistance load)
<ILD control block>							
23	Input resistance 1 (Pins 23, 24)	ZIINR	0.56	0.8	1.04	kΩ	
24	Input resistance 2 (Pins 20, 21, 22)	ZIINW	1.05	1.5	1.95	kΩ	
25	Input/output gain 1, 2	GAINR	110	125	140	—	
26	Input/output gain 3, 4, 5 (DVD)	GAINW1	400	470	510	—	
27	Input/output gain 3, 4, 5 (CD)	GAINW2	400	470	510	—	
28	ILD control linearity 1 (DVD)	LINEA1	-3	—	3	%	Based on linearity when ILD = 50 to 150mA (I _{READ} = 30mA) V _{CC_LD} = 4.5V, V _{CC} = 3V, V ₁ = 1.65V, R _L = 5Ω, ILD = 270mA
29	ILD control linearity 2 (CD)	LINEA2	-3	—	3	%	Based on linearity when ILD = 50 to 150mA (I _{READ} = 30mA) V _{CC_LD} = 4.5V, V _{CC} = 3V, V ₂ = 1V, R _L = 5Ω, ILD = 300mA
30	Input/output R gain relative precision 1		-5	—	5	%	IIN1 = IIN2 = 250μA IIN2 output current precision based on IIN1 output current
31	Input/output R gain relative precision 2		-5	—	5	%	IIN1 = IIN2 = 500μA IIN2 output current precision based on IIN1 output current
32	Input/output R gain relative precision 3		-5	—	5	%	IIN1 = IIN2 = 750μA IIN2 output current precision based on IIN1 output current
33	Input/output W gain relative precision	GACCU	-5	—	5	%	
34	Input/output transmission band	FBAND	7	—	—	MHz	Frequency for input/output gain of -3dB

Test No.	Measurement item	Symbol	Min.	Typ.	Max.	Unit	Condition
<High frequency modulator>							
35	Frequency variable range	VARIF	200	—	600	MHz	
36	Amplitude variable range	VARIAMP	—	—	100	mAp-p	fmod = 400MHz
37	Frequency variation	FREQ	-10	—	11	%	fmod = 400MHz
38	Frequency temperature characteristic	TFREQ	—	TBD	—	%	fmod = 400MHz
39	Amplitude variation	AMP	—	31	—	mAp-p	fmod = 300MHz
40	Amplitude temperature characteristic	TAMP	—	TBD	—	%	fmod = 400MHz
41	OSCEN response time (ON)	OSCRE S1	—	5	—	ns	fmod = 300MHz, RAMP = 10kΩ
42	OSCEN response time (OFF)	OSCRE S2	—	5	—	ns	
<LDEN control>							
43	LDEN response time 1 (ON)	RLDRES1	—	—	1	μs	Time to reach 90% of Read set current (same condition as current consumption 3)
44	LDEN response time 1 (OFF)	RLDRES2	—	—	10	ns	Time to reach 10% of Read set current (same condition as current consumption 3)
45	LDEN response time 2 (ON)	WLDRES1	—	—	1	μs	Time to reach 90% of Write set current (same condition as current consumption 4)
46	LDEN response time 2 (OFF)	WLDRES2	—	—	10	ns	Time to reach 10% of Write set current (same condition as current consumption 4)

Electrical Characteristics Measurement Circuit

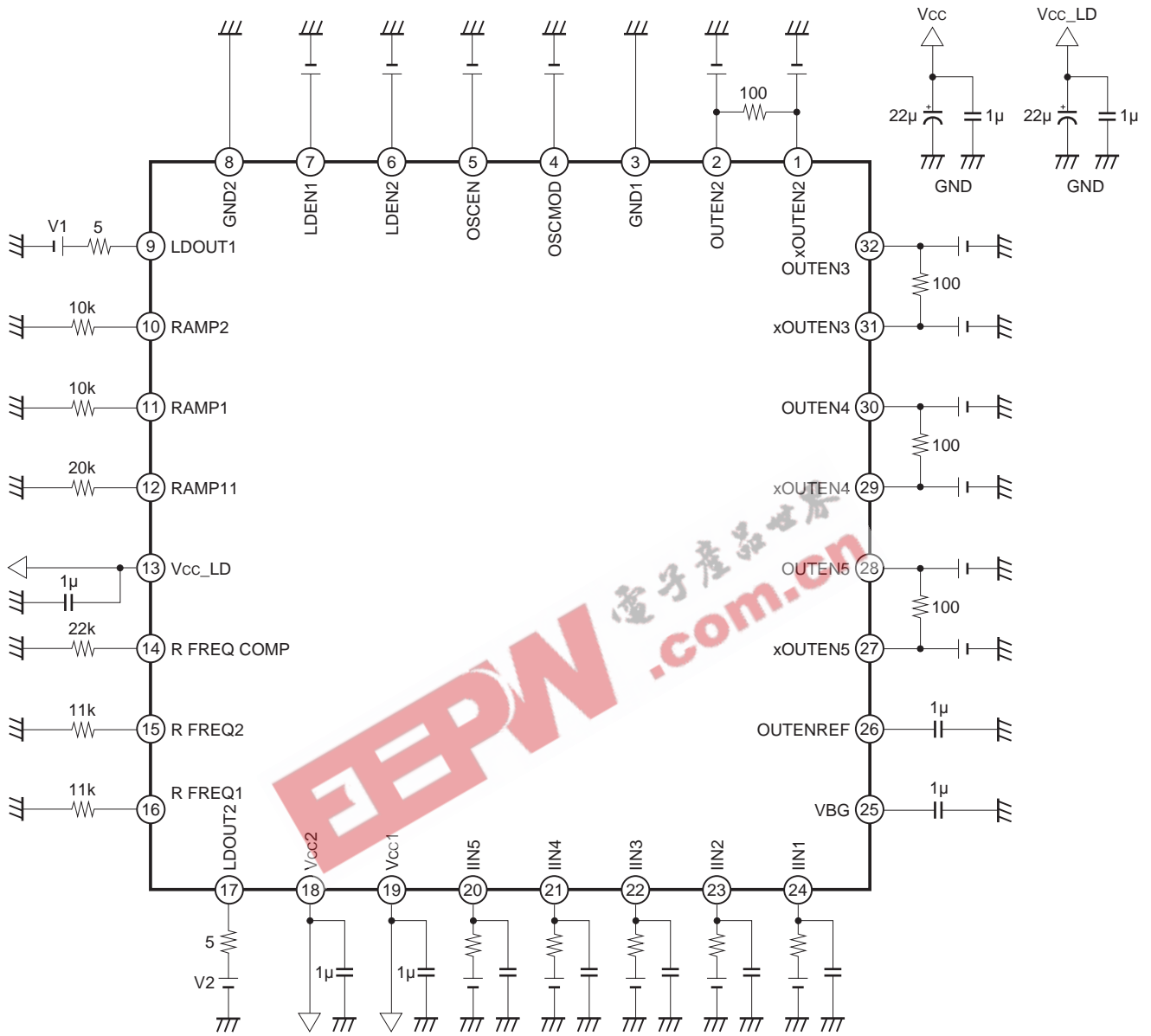

Description of Operation

(1) LD Drive Current Value Setting

The current controlled by the current setting pins IIN1, IIN2, IIN3, IIN4 and IIN5 is output from the LDOUT1 and LDOUT2 pins. IIN1, IIN2, IIN3, IIN4 and IIN5 can be set respectively by OUTEN and xOUTEN for the output drive current from the LDOUT pin.

(2) Differential Input and Single-end Input

External processing is required for the differential input and single-end input switching. For the single-end input, if the device is used at the active Low, the OUTENREF pin and the OUTEN pin should be shorted externally; if it is used at the active High, the OUTENREF pin and the xOUTEN pin should be shorted externally. Leave the OUTENREF pin open for the differential input.

(3) Modulator Circuit

The modulator ON/OFF is controlled by the OSCEN pin. For the DVD side, the modulator frequency is varied by the external resistance connected to the RFREQ1 pin and the modulator amplitude can be varied by the external resistance connected to the RAMP1 pin when the OSCMOD is high, and the RAMP11 pin when it is low. For the CD side, the modulator frequency is varied by the external resistance connected to the RFREQ2 pin and the modulator amplitude can be varied by the external resistance connected to the RAMP2 pin.

(4) R FREQ COMP Pin

The current depending on the internal resistance is generated using the R FREQ COMP pin external resistance to suppress the dispersion of the modulator frequency depending on the internal resistance. The R FREQ COMP pin external resistance is recommended to be fixed to 22kΩ.

(5) Modulator Level Adjustment

The modulator level adjustment can be performed by varying the IIN1 input current value.

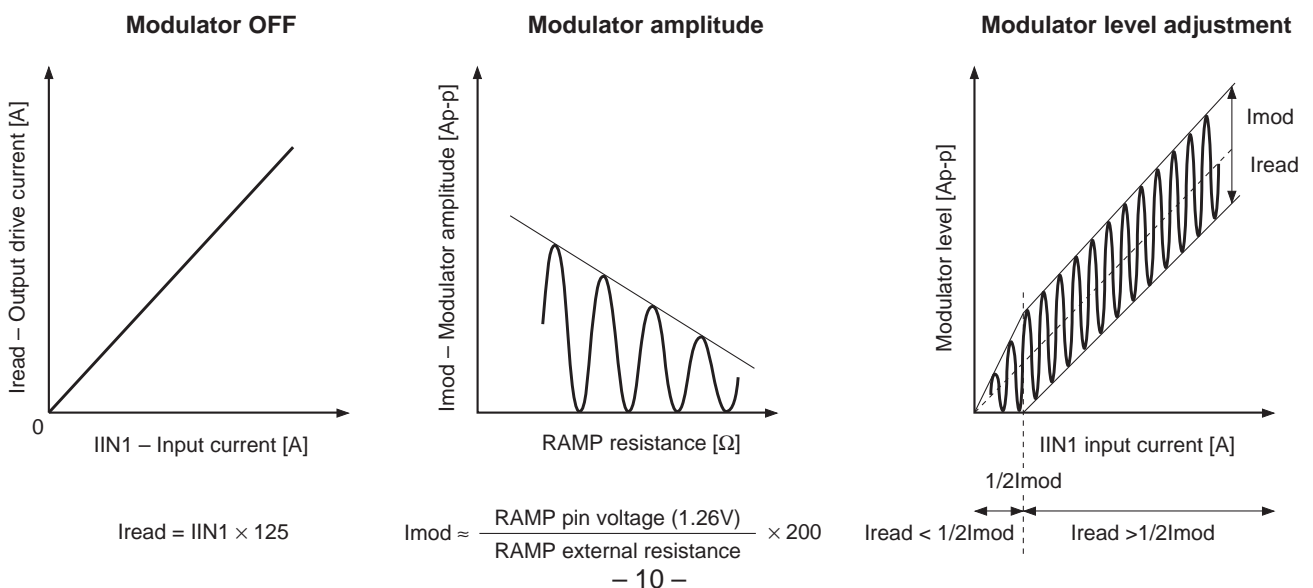

Description of Functions

1. Logic Table

Output control

		IN1/IN2	IN3	IN4	IN5				
LDEN1	LDEN2	xOUTEN2	xOUTEN3	xOUTEN4	xOUTEN5	OSCEN	OSCMOD	LDOUT1 (DVD)	LDOUT2 (CD)
L	L	X	X	X	X	X	X	OFF	OFF
H	L	H	H	H	H	L	L	IIN1 × 125	OFF
H	L	L	H	H	H	L	L	IIN2 × 125	OFF
H	L	H	L	H	H	L	L	IIN1 × 125 + IIN3 × 470	OFF
H	L	H	H	L	H	L	L	IIN1 × 125 + IIN4 × 470	OFF
H	L	H	H	H	L	L	L	IIN1 × 125 + IIN5 × 470	OFF
H	L	H	L	L	L	L	L	IIN1 × 125 + (IIN3 + IIN4 + IIN5) × 470	OFF
L	H	H	H	H	H	L	L	OFF	IIN1 × 125
L	H	L	H	H	H	L	L	OFF	IIN2 × 125
L	H	H	L	H	H	L	L	OFF	IIN1 × 125 + IIN3 × 470
L	H	H	H	L	H	L	L	OFF	IIN1 × 125 + IIN4 × 470
L	H	H	H	H	L	L	L	OFF	IIN1 × 125 + IIN5 × 470
L	H	H	L	L	L	L	L	OFF	IIN1 × 125 + (IIN3 + IIN4 + IIN5) × 470
H	H	X	X	X	X	X	X	OFF (INHIBIT)	OFF (INHIBIT)

Module control

LDEN1	LDEN2	xOUTEN2	xOUTEN3	xOUTEN4	xOUTEN5	OSCEN	OSCMOD	LDOUT1	LDOUT2
L	L	X	X	X	X	X	X	OFF	OFF
H	L	X	X	X	X	L	H	MODOFF	OFF
H	L	X	X	X	X	H	H	MODON (R FREQ1, RAMP1)	OFF
H	L	X	X	X	X	H	L	MODON (R FREQ1, RAMP11)	OFF
L	H	X	X	X	X	L	X	OFF	MODOFF
L	H	X	X	X	X	H	X	OFF	MODON (R FREQ2, RAMP2)
H	H	X	X	X	X	X	X	OFF (INHIBIT)	OFF (INHIBIT)

Note: Module control does not depend on a data timing signals.

2. Timing Chart

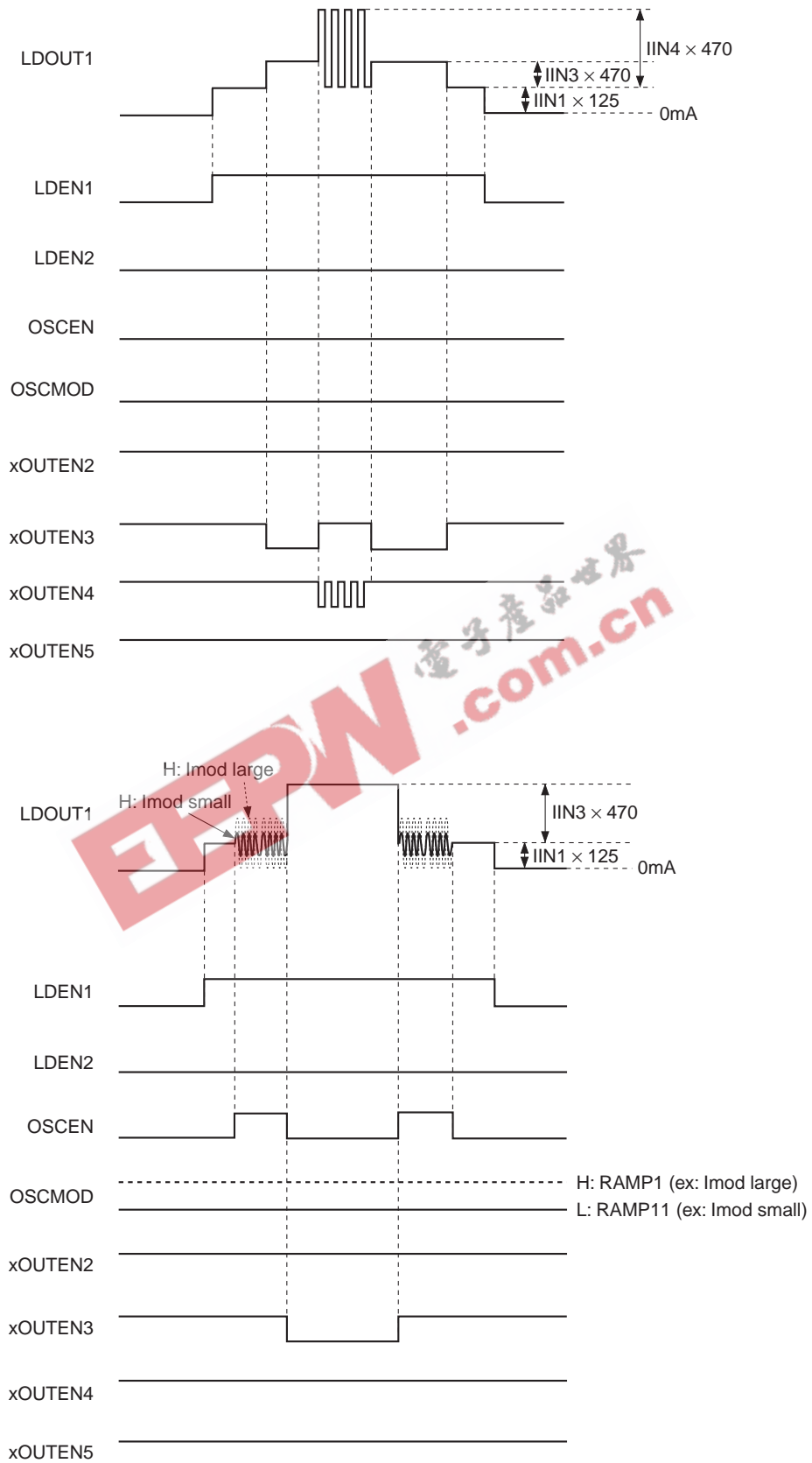

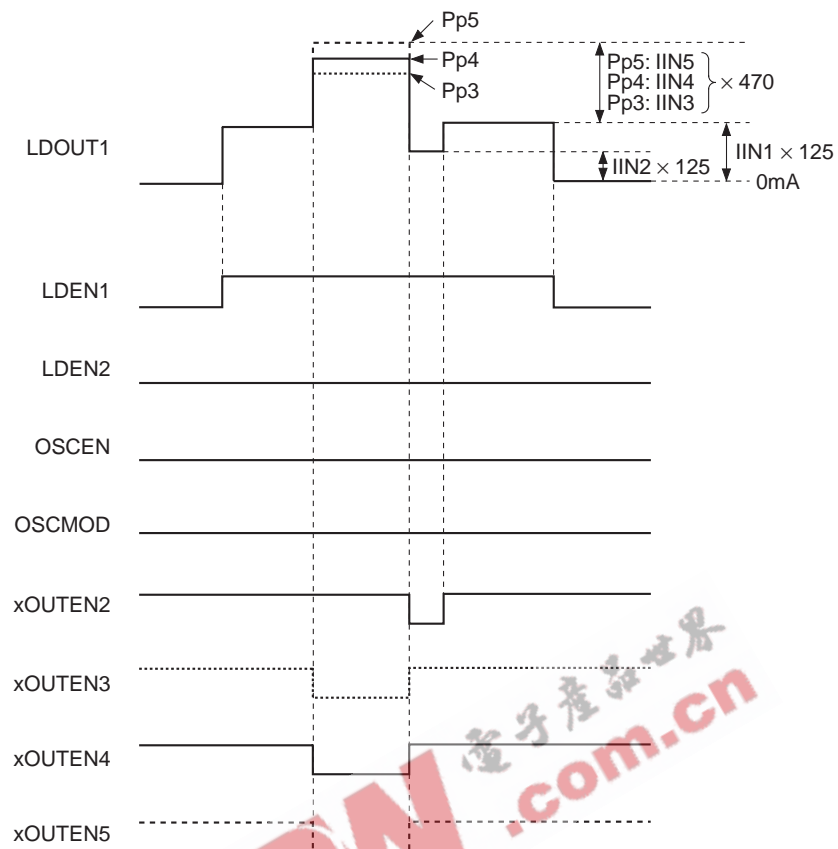

Notes on Operation

- Arrange the external resistance connected to the IIN1, IIN2, IIN3, IIN4 and IIN5 pins near the IC package to reduce the influence from other signal lines.
- Wiring between the output LDOUT pin and the laser diode, and wiring between the Vcc_LD pin and external decoupling capacitance should be the shortest. Making the distance for wiring long increases output waveform overshoots and undershoots caused by the influence of wiring inductance.
- The Vcc_LD pin's external decoupling capacitance ground can be grounded to the GND grounding the load from the LDOUT pin. This reverses the phase of the drive waveform at the LDOUT and Vcc_LD and moves in the direction that suppresses overshoots and undershoots.

Temperature guarantee

Thermal resistance (θ_j -a) when the CXA2697ER is mounted on PWB varies according to the set (PWB) and because it is difficult to predict along with the tendency for higher power for power consumption (P_o), the following points should be considered when using.

Use in a range that does not exceed a junction temperature of 150°C. Also, power consumption (P_o) should be below allowable power dissipation (P_D). Use with the thermal resistance (θ_j -a) of the PWB mounting lowered so that it can be operated normally at a maximum operating temperature of 75°C. To lower θ_j -a, radiating measures on the set, such as widening the GND region with the set PWB are needed. Also, the die-pad on the CXA2697ER 32-pin VQFN package is exposed on the surface, so thermal transmission from the IC surface is excellent. For that reason, it is possible to release heat to the set chassis thereby lowering the thermal resistance of the PWB mount.

Find the thermal resistance (θ_j -a) when mounted on PWB and power consumption (P_o) using the following method.

$$P_o = (I_{cc} \times V_{cc}) - (I_{op} \times V_{op})$$

I_{cc} : IC current consumption when operating (Including I_{op})

I_{op} : Output drive current flowed from the LDOUT pin to the Laser Diode

V_{op} : Operating voltage of the laser diode

Thermal resistance (θ_j -a) when mounted on PWB

Diode temperature coefficient $XXmV/^\circ C$ and the positive protection diode temperature characteristics are used to find this.

The V_2 voltage found in (2) below cancels the voltage decrease caused by the wiring resistance between the positive protection diode connection Vcc and the Vcc pins as reference and is measured to find the precise temperature characteristics of the positive protection diode.

- (1) V_1 to LDEN pin voltage to Vcc pin voltage, I_{cc1} to current consumption when 0V is applied to the IIN1, IIN2, IIN3, IIN4 and IIN5 pins.
- (2) V_2 to LDEN pin voltage to Vcc pin voltage immediately after applying the arbitrary voltage to the IINx pin.
- (3) V_3 to LDEN pin voltage to Vcc pin voltage, I_{cc3} to current consumption when applying the arbitrary voltage to the IINx pin and heat reaches equilibrium.

ΔT_j using the voltage drop (V_1 to V_2) between the positive protection diode connection Vcc and the Vcc pins that are the reference, as described above are:

$$\Delta T_j = ((V_3 + (V_1 - V_2)) - V_1) / XXmV/^\circ C$$

Thermal resistance (θ_j -a) is:

$$\theta_j\text{-a} = \Delta T_j / (I_{cc3} - I_{cc1}) \times V_{cc} - I_{op} \times V_{op}$$

- Allowable power dissipation (P_D) $\geq P_o$ [W]

$$P_D = (150^\circ C - \text{Ambient temperature}) / \theta_j\text{-a}$$

- Maximum operating temperature 75°C

$$(150^\circ C - \Delta T_j) \geq 75^\circ C$$

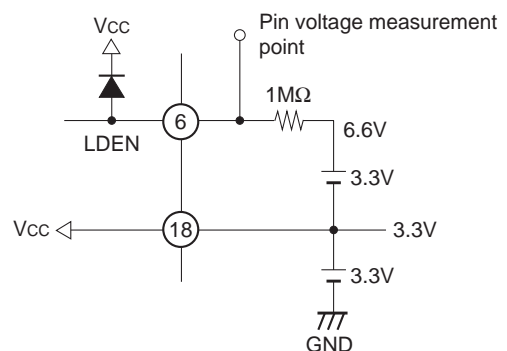

Example of Representative Characteristics

IIN1, IIN2 input current vs. CD/DVD output current characteristics
 Vcc_LD = 5V, Vcc = 3.3V, resistance load

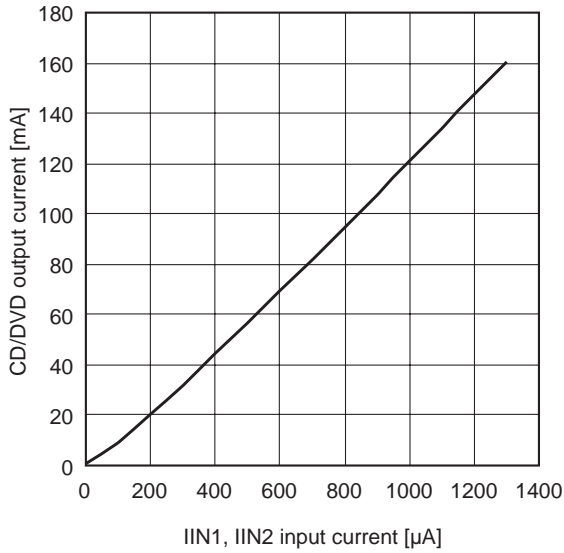

IIN3, IIN4, IIN5 input current vs. CD/DVD output current characteristics
 Vcc_LD = 5V, Vcc = 3.3V, resistance load

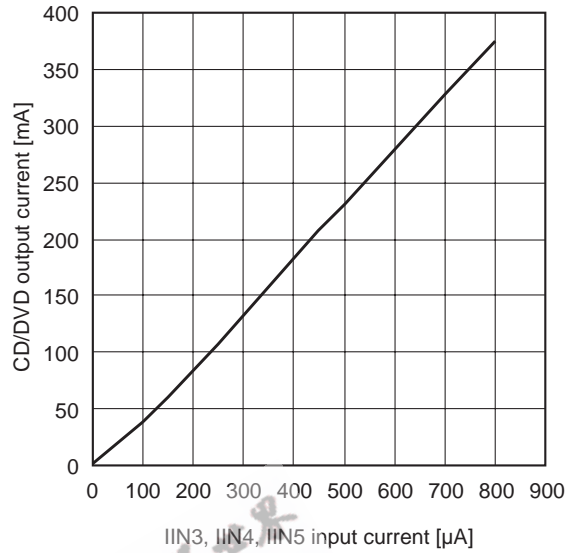

Modulator frequency control characteristics
 I_{mod} = 40mA_{p-p} (RAMP = 5kΩ)
 R FREQ COMP = 22kΩ

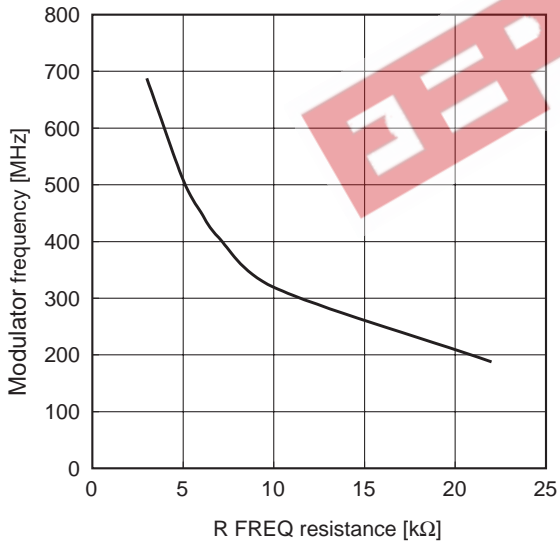

RAMP resistance value vs. Modulator waveform peak current characteristics
 f_{mod} = 400MHz (R FREQ = 7kΩ)
 R FREQ COMP = 22kΩ

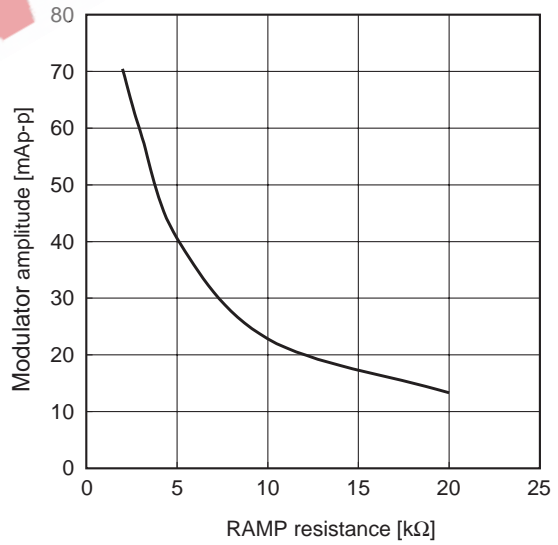

Application Circuit 1

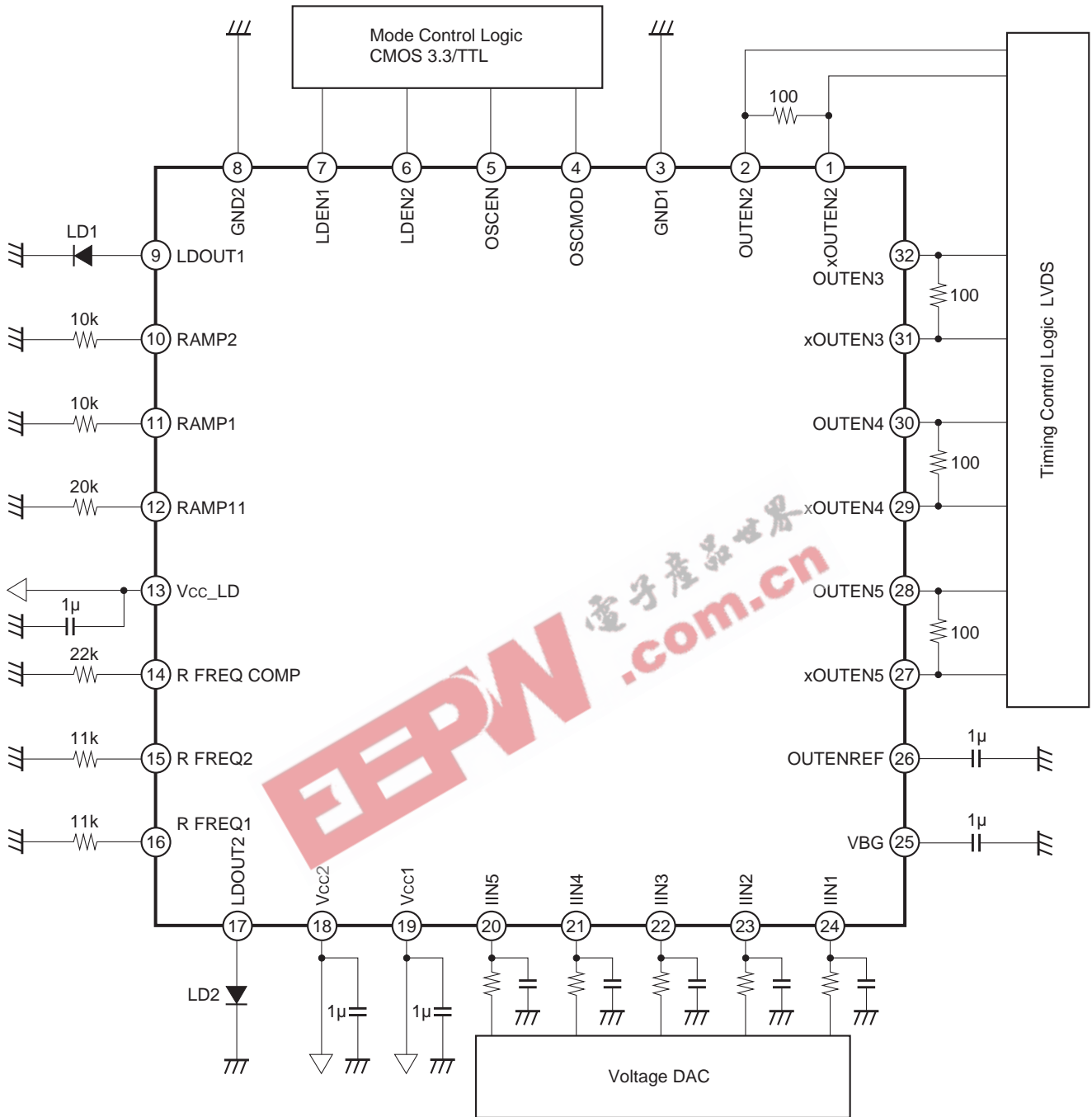

Application circuits shown are typical examples illustrating the operation of the devices. Sony cannot assume responsibility for any problems arising out of the use of these circuits or for any infringement of third party patent and other right due to same.

Application Circuit 2

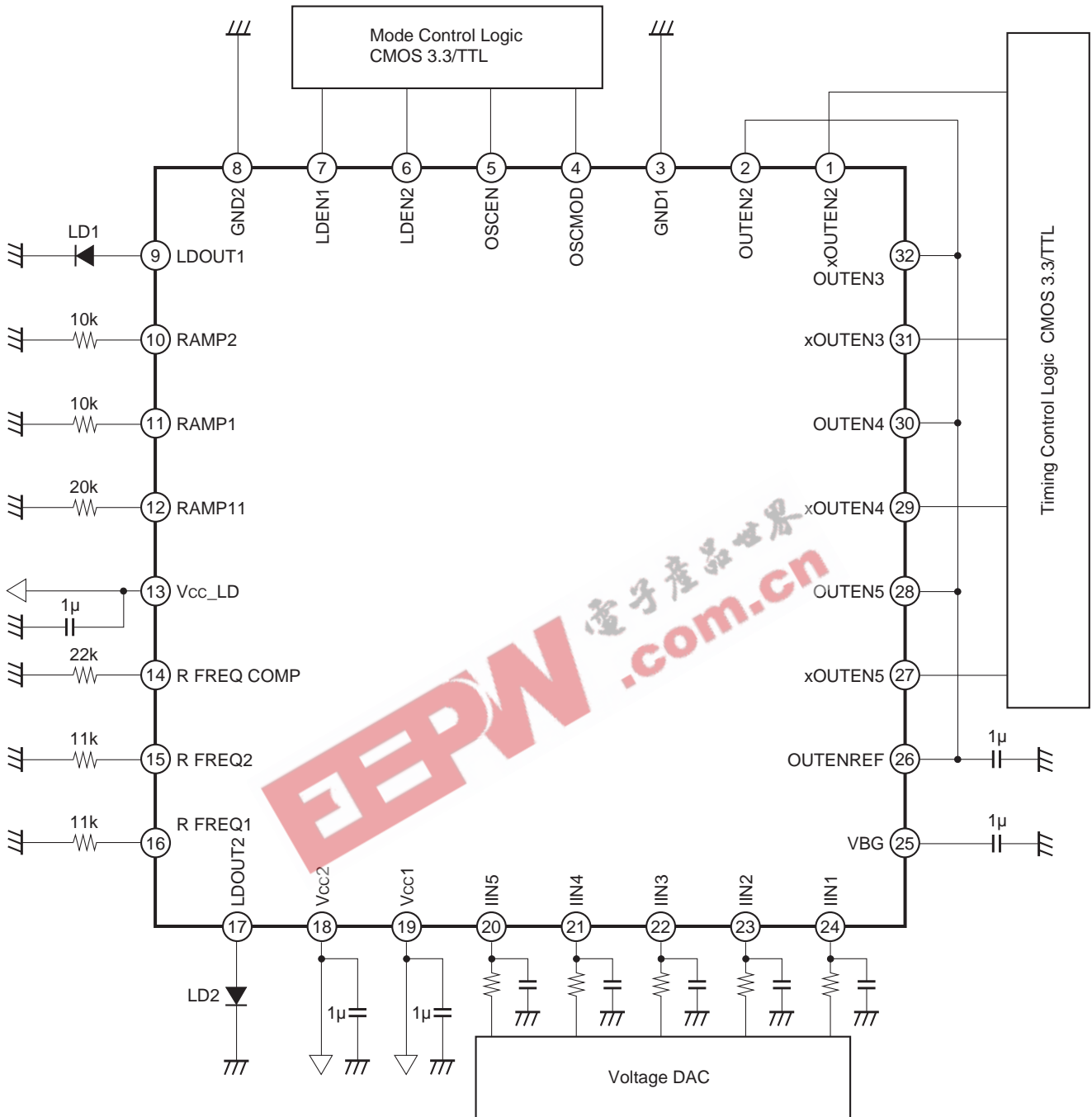

Application circuits shown are typical examples illustrating the operation of the devices. Sony cannot assume responsibility for any problems arising out of the use of these circuits or for any infringement of third party patent and other right due to same.

Package Outline

Unit: mm

32PIN VQFN (PLASTIC)

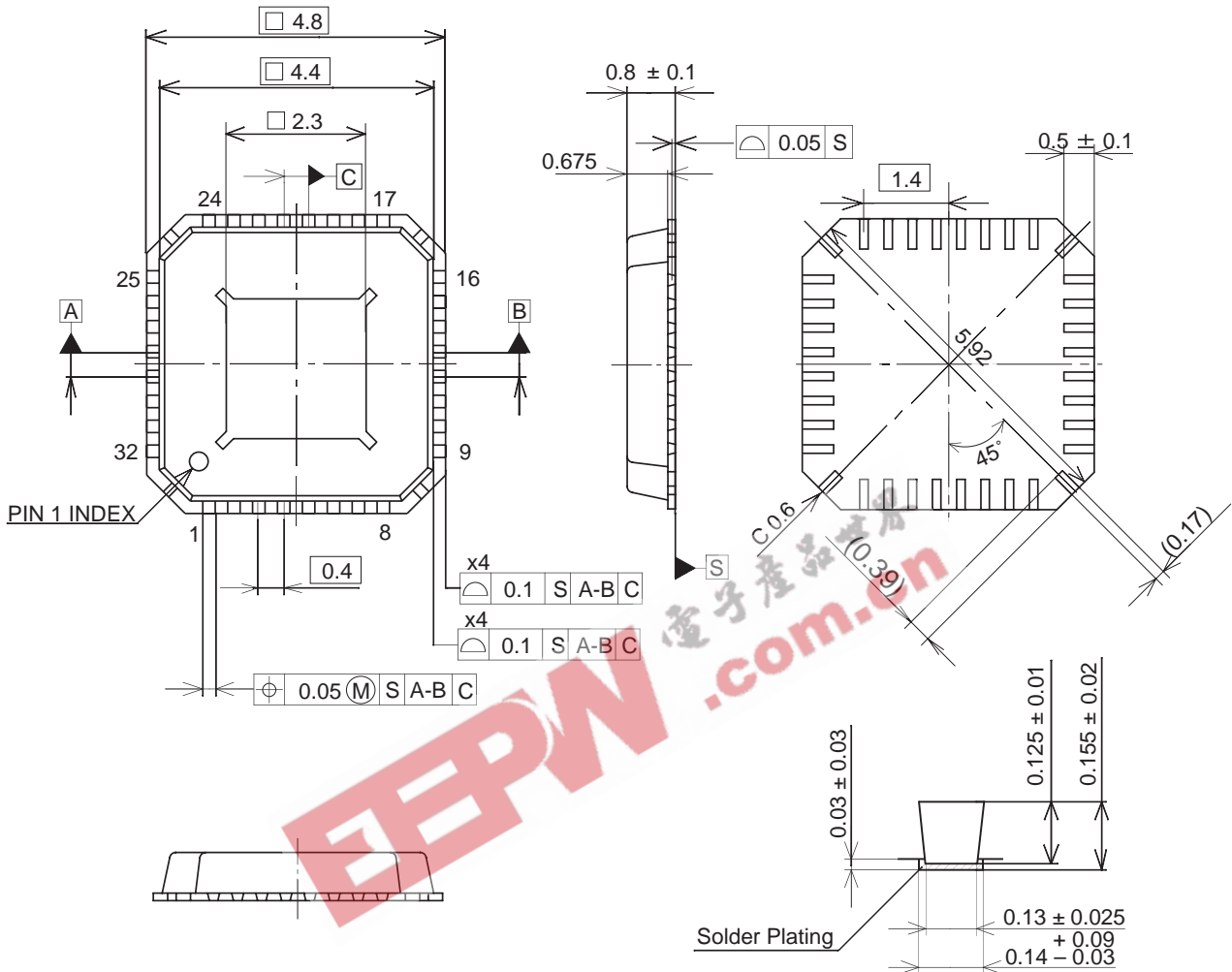

NOTE:1)The dimensions of the terminal section apply to the ranges of 0.1mm and 0.25mm from the end of a terminal.

TERMINAL SECTION

PACKAGE STRUCTURE

SONY CODE	VQFN-32P-07
EIAJ CODE	_____
JEDEC CODE	_____

PACKAGE MATERIAL	EPOXY RESIN
LEAD TREATMENT	SOLDER PLATING
LEAD MATERIAL	COPPER ALLOY
PACKAGE MASS	0.04g