

# Silicon Bipolar MMIC 2.5 GHz Variable Gain Amplifier

## Technical Data

**IVA-14208  
IVA-14228**

### Features

- **Differential Input and Output Capability**
- **DC to 2.5 GHz Bandwidth;  
3.4 Gbits/s Data Rates**
- **High Gain:** 24 dB Typical
- **Wide Gain Control Range:**  
34 dB Typical
- **6 V Bias**
- **5 V  $V_{GC}$  Control Range,  
 $I_{GC} < 3\text{ mA}$**
- **Fast Gain Response:**  $< 10\text{ nsec}$   
Typical
- **IVA-14208:** Low Cost Plastic  
Surface Mount Package
- **IVA-14228:** Hermetic Ceramic  
Surface Mount Package

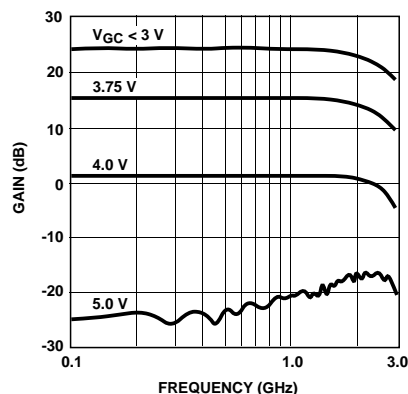

Figure 1. IVA-14228 Typical Variable Gain vs. Frequency and  $V_{GC}$  at  $V_{CC} = 6\text{ V}$ ,  $T_{case} = 25^\circ\text{C}$ .

### Description

The IVA-14 series MMICs are variable gain amplifiers. The IVA-14208 is housed in a miniature low cost plastic surface mount package. The IVA-14228 is housed in a miniature hermetic ceramic surface mount package. Both devices can be used in any combination of single-ended or differential inputs or outputs (see Functional Block Diagram). The lowest frequency of operation is limited only by the values of user selected blocking and bypass capacitors.

Typical applications include variable gain amplification or limiting for fiber optic systems (e.g. SONET) with data rates up to 3.4 Gbits/s, mobile radio and satellite receivers, millimeter wave receiver IF amplifiers and communications receivers.

The IVA series of variable gain amplifiers is fabricated using Hewlett-Packard's 10 GHz  $f_T$ , 25 GHz  $f_{MAX}$  ISOSAT™-1 silicon bipolar process. This process uses nitride self-alignment, sub-micrometer lithography, trench isolation, ion implantation, gold metallization and polyimide inter-metal dielectric and scratch protection to achieve excellent performance, uniformity and reliability.

**IVA-14208  
Plastic SO-8 Package**

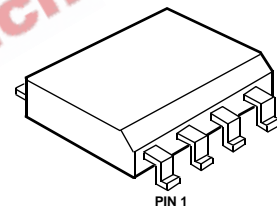

**IVA-14228  
Ceramic '28' Package**

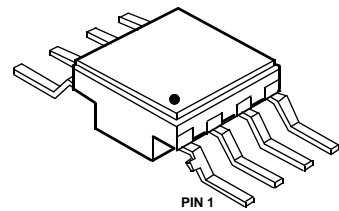

### Functional Block Diagram and Pin Configuration

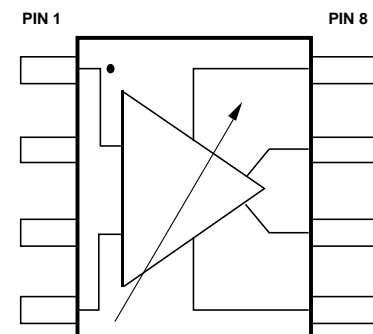

PIN DESCRIPTION	
1. INPUT +	8. $V_{GC}$
2. $V_{EE}$ , AC GROUND	7. OUTPUT +
3. $V_{EE}$ , AC GROUND	6. OUTPUT -
4. INPUT -	5. $V_{CC}$

IVA-14228 PACKAGE BOTTOM IS  $V_{EE}$  AC GROUND.

## IVA-14208, -14228 Absolute Maximum Ratings<sup>[1]</sup>

Symbol	Parameter	Units	IVA-14208	IVA-14228
$V_{CC}-V_{EE}$	Device Voltage, $T_{case} = 25^{\circ}C$	Volts	12	12
$P_{in}$	Input Power, $T_{case} = 25^{\circ}C$	dBm	13	13
$V_{GC}-V_{EE}$	Control Voltage, $T_{case} = 25^{\circ}C$	Volts	10	10
$T_i$	Junction Temperature +	$^{\circ}C$	150	200
$T_{stg}$	Storage Temperature	$^{\circ}C$	-65 to +150	-65 to +200
$P_t$	Total Device Dissipation	mW	1000 <sup>[2]</sup>	1000 <sup>[3]</sup>

### Thermal Resistance:

IVA-14208 Thermal Resistance Junction to Case<sup>[4]</sup>:  $\theta_{jc} = 68^{\circ}C/W$   
 IVA-14228 Thermal Resistance Junction to Case<sup>[4]</sup>:  $\theta_{jc} = 63^{\circ}C/W$

### Notes:

1. Operation in excess of any one of these conditions may result in permanent damage to the device.
2.  $T_{case} = 25^{\circ}C$ . Derate at 14.7 mW/ $^{\circ}C$  for  $T_{case} > 82^{\circ}C$ .
3.  $T_{case} = 25^{\circ}C$ . Derate at 15.9 mW/ $^{\circ}C$  for  $T_{case} > 137^{\circ}C$ .
4.  $T_j = 150^{\circ}C$ .

## IVA-14208, -14228 Guaranteed Electrical Specifications

All measurements reflect single-ended (unbalanced) performance.  $T_{case} = 25^{\circ}C$ .  $V_{CC} = 6V$ ,  $V_{EE} = 0V$ ,  $V_{GC} = 0V$ ,  $Z_L = 50\Omega$

Symbol	Parameter	Units	IVA-14208			IVA-14228		
			Min.	Typ.	Max.	Min.	Typ.	Max.
GP	Power Gain ( $ S_{21} ^2$ ), $f = 1$ GHz	dB	20	24		22	24	
$\Delta GP$	Gain Flatness, $f = 0.05$ to 2 GHz	dB		$\pm 1.2$			$\pm 0.7$	
$f_{3dB}$	3 dB Bandwidth	GHz	2.0	2.5		2.2	2.5	
GCR	Gain Control Range <sup>[2]</sup> , $f = 1$ GHz, $V_{GC} = 0$ to 5 V	dB	30	34		30	34	
ISO	Reverse Isolation ( $ S_{12} ^2$ ), $f = 1$ GHz, $V_{GC} = 0$ to 5 V	dB		37			40	
VSWR	Input VSWR, $f = 0.05$ to 2.0 GHz, $V_{GC} = 0$ to 5 V			2:1			2:1	
	Output VSWR, $f = 0.05$ to 2.0 GHz, $V_{GC} = 0$ to 5 V			2:1			2.5:1	
NF	50 $\Omega$ Noise Figure, $f = 1$ GHz	dB		9.0			9.0	
$P_{1dB}$	Output Power at 1 dB Gain, Compression $f = 1$ GHz	dBm		-2.0			-2.0	
$V_{OUT}$	Pk-Pk Single-ended Output Voltage, $f = 1$ GHz	mVpp		450			450	
$IP_3$	Third Order Intercept Point, $f = 1$ GHz	dBm		8			8	
$t_D$	Group Delay, $f = 1$ GHz	psec		450			450	
$I_{cc}$	Supply Current	mA	28	38	48	28	38	48

### Notes:

1. The recommended operating voltage range for these devices is 5 to 8 V. Typical performance as a function of voltage is shown in the graphs on the following pages.
2. The recommended gain control range for these devices for dynamic control is 0 to 4.2 V. Operation at gain control settings above 4.2 V may result in gain control increase rather than gain decrease. See figures 4 and 19.

## IVA-14228 Typical Performance Curves

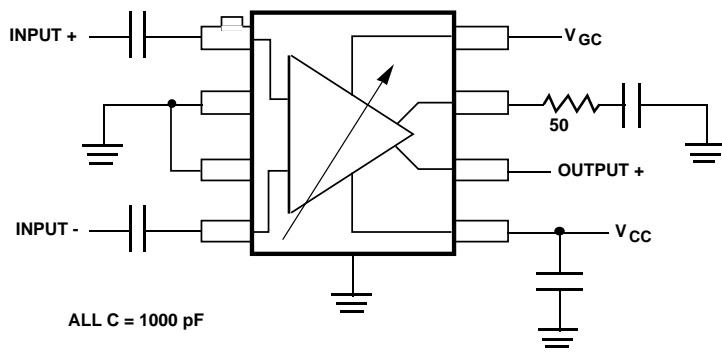

Figure 2. IVA-142X8 Connection Diagram Showing Balanced Inputs and Unbalanced Outputs. Inputs and Outputs May Be Either Balanced or Unbalanced.

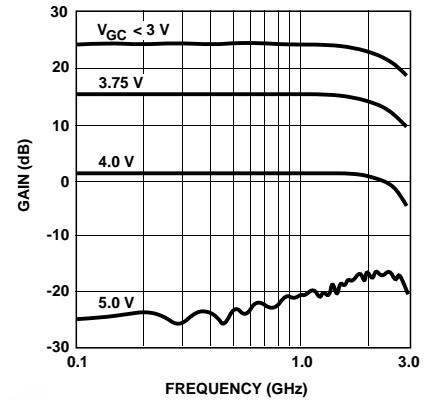

Figure 3. IVA-14228 Gain vs. Frequency and V<sub>GC</sub>; V<sub>CC</sub> = 6 V, T<sub>case</sub> = 25°C.

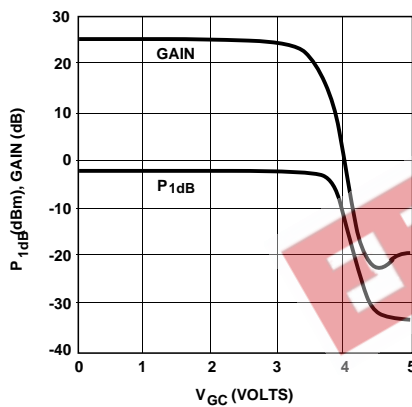

Figure 4. IVA-14228 P<sub>1dB</sub> and Gain vs. V<sub>GC</sub>; V<sub>CC</sub> = 6 V, T<sub>case</sub> = 25°C.

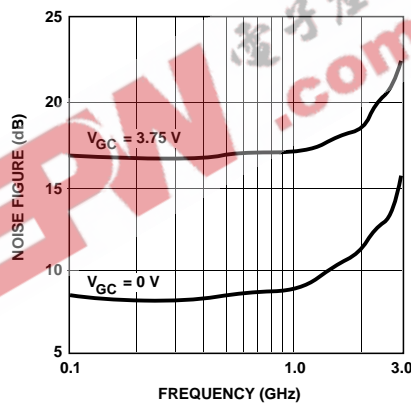

Figure 5. IVA-14228 Noise Figure vs. Frequency and V<sub>GC</sub>; V<sub>CC</sub> = 6 V, T<sub>case</sub> = 25°C.

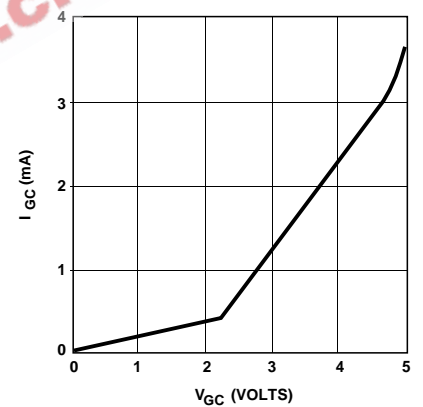

Figure 6. IVA-14228 I<sub>GC</sub> vs. V<sub>GC</sub>; V<sub>CC</sub> = 6 V, T<sub>case</sub> = 25°C.

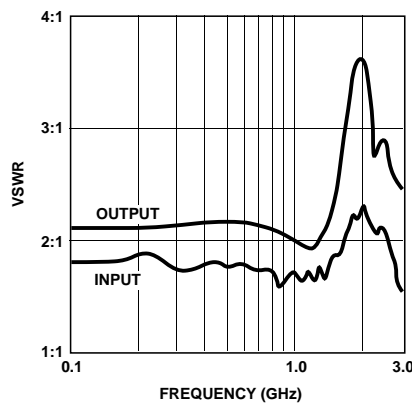

Figure 7. IVA-14228 VSWR vs. Frequency; V<sub>CC</sub> = 6 V, V<sub>GC</sub> = 0 V, T<sub>case</sub> = 25°C.

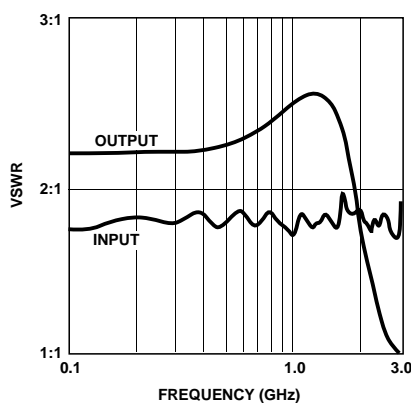

Figure 8. IVA-14228 VSWR vs. Frequency; V<sub>CC</sub> = 6 V, V<sub>GC</sub> = 5 V, T<sub>case</sub> = 25°C.

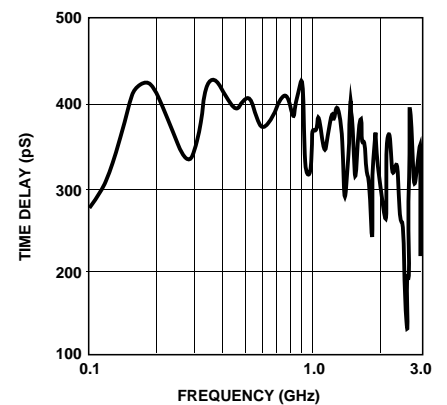

Figure 9. IVA-14228 Group Delay vs. Frequency; V<sub>GC</sub> = 0 V, V<sub>CC</sub> = 6 V, T<sub>case</sub> = 25°C.

## IVA-14228 Typical Performance Curves (cont.)

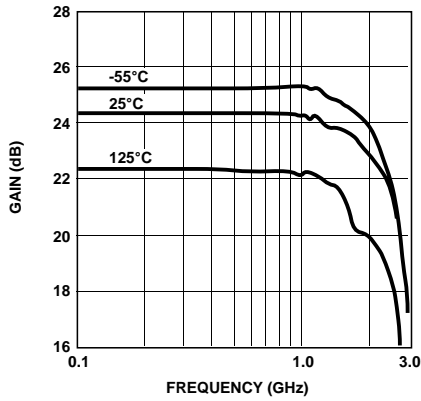

Figure 10. IVA-14228 Gain vs. Frequency and Temperature;  $V_{CC} = 6\text{ V}$ ,  $V_{GC} = 0\text{ V}$ .

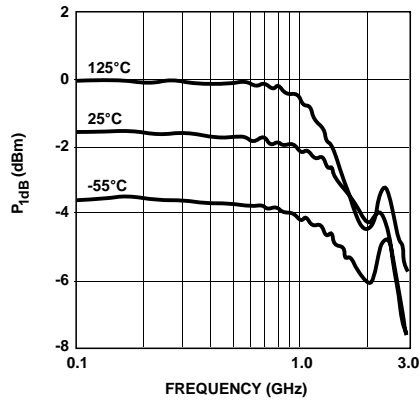

Figure 11: IVA-14228  $P_{1dB}$  vs. Frequency and Temperature;  $V_{CC} = 6\text{ V}$ ,  $V_{GC} = 0\text{ V}$ .

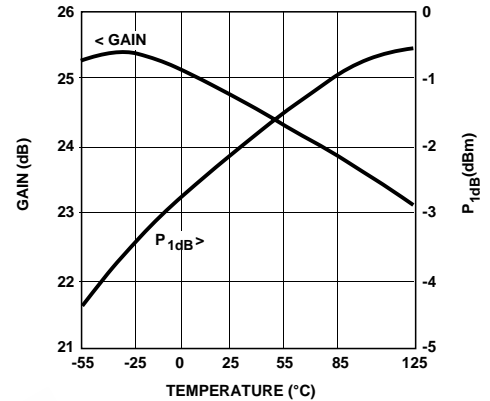

Figure 12. IVA-14228 Gain and  $P_{1dB}$  vs. Temperature;  $V_{CC} = 6\text{ V}$ ,  $V_{GC} = 0\text{ V}$ , Frequency = 1 GHz.

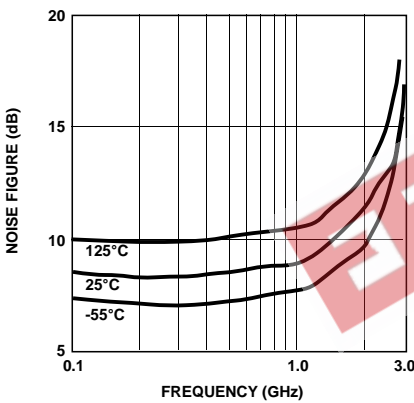

Figure 13. IVA-14228 Noise Figure vs. Frequency and Temperature;  $V_{CC} = 6\text{ V}$ ,  $V_{GC} = 0\text{ V}$ .

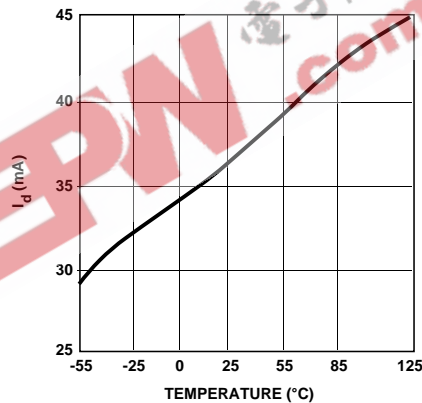

Figure 14. IVA-14228  $I_{CC}$  vs. Temperature;  $V_{CC} = 6\text{ V}$ ,  $V_{GC} = 0\text{ V}$ , Frequency = 1 GHz.

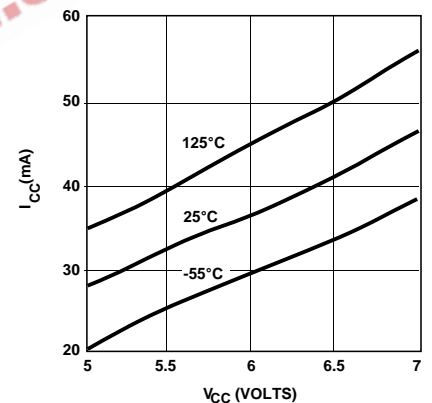

Figure 15. IVA-14228  $I_{CC}$  vs.  $V_{CC}$  and Temperature;  $V_{GC} = 0\text{ V}$ .

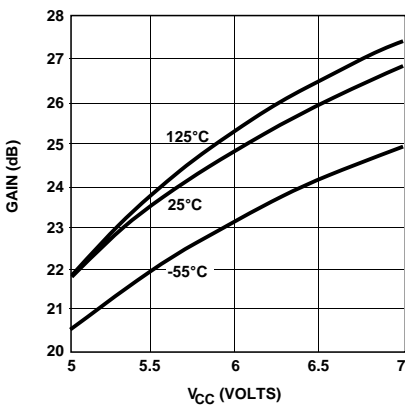

Figure 16. IVA-14228 Gain vs.  $V_{CC}$  and Temperature;  $V_{GC} = 0\text{ V}$ , Frequency = 1 GHz.

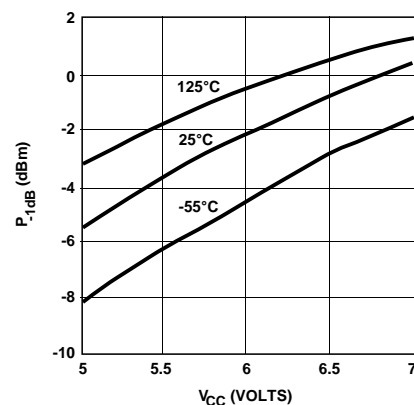

Figure 17. IVA-14228  $P_{1dB}$  vs.  $V_{CC}$  and Temperature;  $V_{GC} = 0\text{ V}$ , Frequency = 1 GHz.

## IVA-14208 Typical Performance Curves

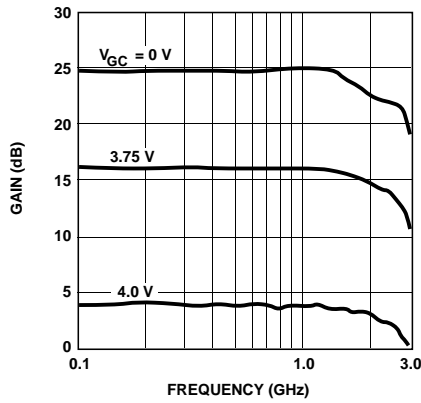

Figure 18. IVA-14208 Gain vs. Frequency and  $V_{GC}$ ;  $V_{CC} = 6\text{ V}$ ,  $T_{case} = 25\text{ }^{\circ}\text{C}$ .

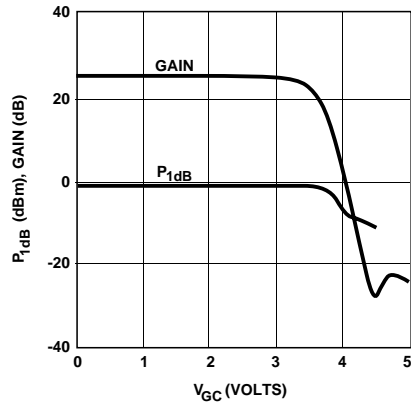

Figure 19. IVA-14208 Gain and  $P_{1dB}$  vs.  $V_{GC}$ ;  $V_{CC} = 6\text{ V}$ , Frequency = 1 GHz,  $T_{case} = 25\text{ }^{\circ}\text{C}$ .

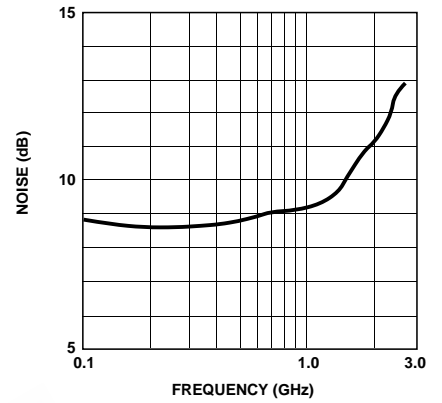

Figure 20. IVA-14208 Noise Figure vs. Frequency;  $V_{CC} = 6\text{ V}$ ,  $V_{GC} = 0\text{ V}$ ,  $T_{case} = 25\text{ }^{\circ}\text{C}$ .

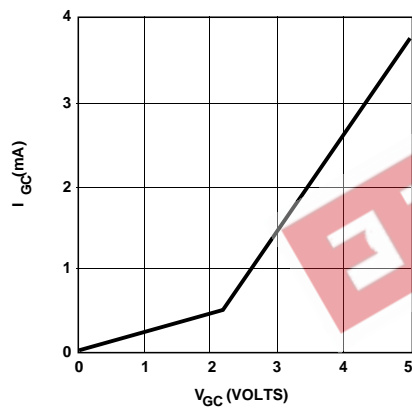

Figure 21. IVA-14208  $I_{GC}$  vs.  $V_{GC}$ ;  $V_{CC} = 6\text{ V}$ ,  $T_{case} = 25\text{ }^{\circ}\text{C}$ .

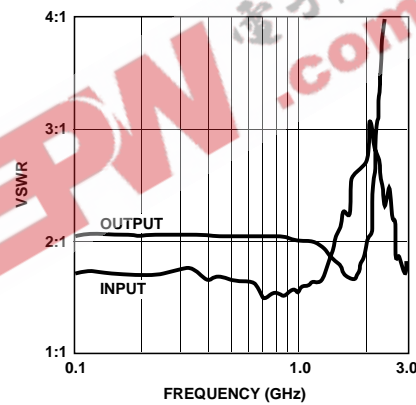

Figure 22. IVA-14208 VSWR vs. Frequency;  $V_{CC} = 6\text{ V}$ ,  $V_{GC} = 0\text{ V}$ ,  $T_{case} = 25\text{ }^{\circ}\text{C}$ .

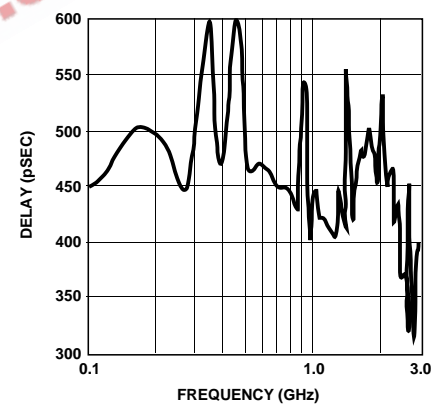

Figure 23. IVA-14208 Group Delay vs. Frequency;  $V_{CC} = 6\text{ V}$ ,  $V_{GC} = 0\text{ V}$ ,  $T_{case} = 25\text{ }^{\circ}\text{C}$ .

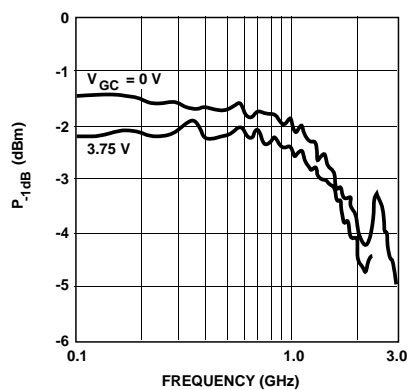

Figure 24. IVA-14208  $P_{1dB}$  vs. Frequency and  $V_{GC}$ ;  $V_{CC} = 6\text{ V}$ , Frequency = 1 GHz,  $T_{case} = 25\text{ }^{\circ}\text{C}$ .

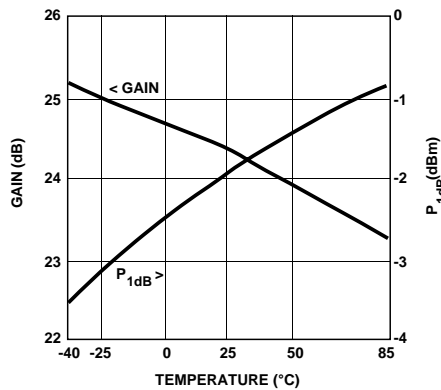

Figure 25. IVA-14208 Gain and  $P_{1dB}$  vs. Temperature;  $V_{CC} = 6\text{ V}$ ,  $V_{GC} = 0\text{ V}$ , Frequency = 1 GHz.

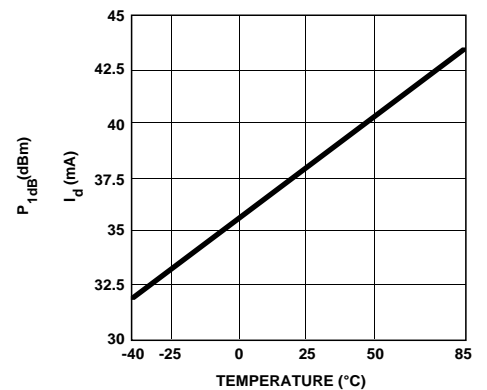

Figure 26. IVA-14208  $I_{GC}$  vs. Temperature;  $V_{CC} = 6\text{ V}$ ,  $V_{GC} = 0\text{ V}$ .

### IVA-14208 Typical Performance Curves (cont.)

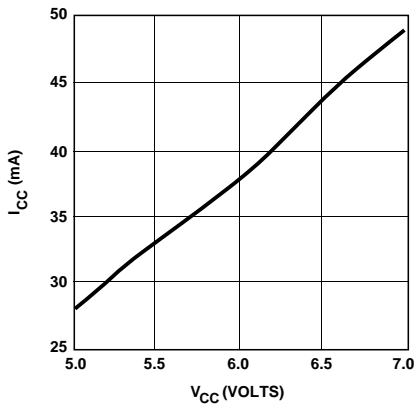

Figure 27. IVA-14208 I<sub>CC</sub> vs. V<sub>CC</sub>; V<sub>GC</sub> = 0 V, T<sub>case</sub> = 25°C.

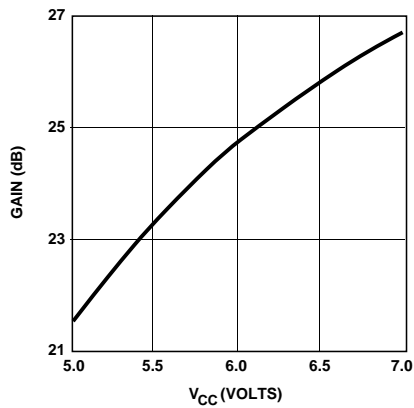

Figure 28. IVA-14208 Gain vs. V<sub>CC</sub>; V<sub>GC</sub> = 0 V, Frequency = 1 GHz, T<sub>case</sub> = 25 °C.

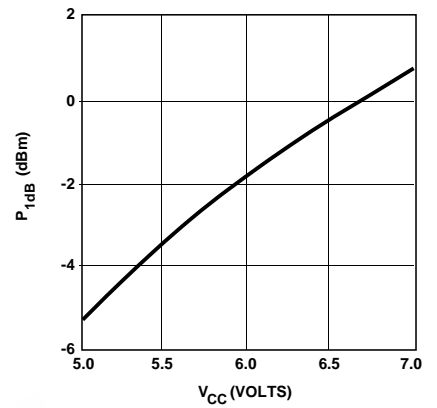

Figure 29. IVA-14208 P<sub>1dB</sub> vs. V<sub>CC</sub>; V<sub>GC</sub> = 0 V, Frequency = 1 GHz, T<sub>case</sub> = 25 °C.

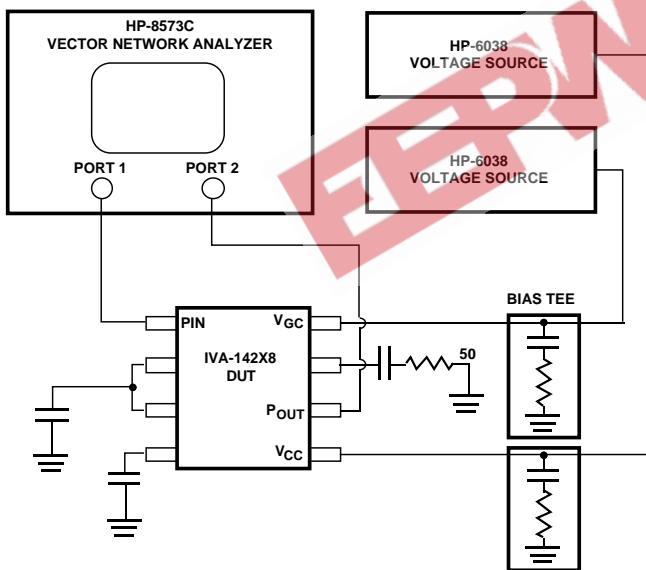
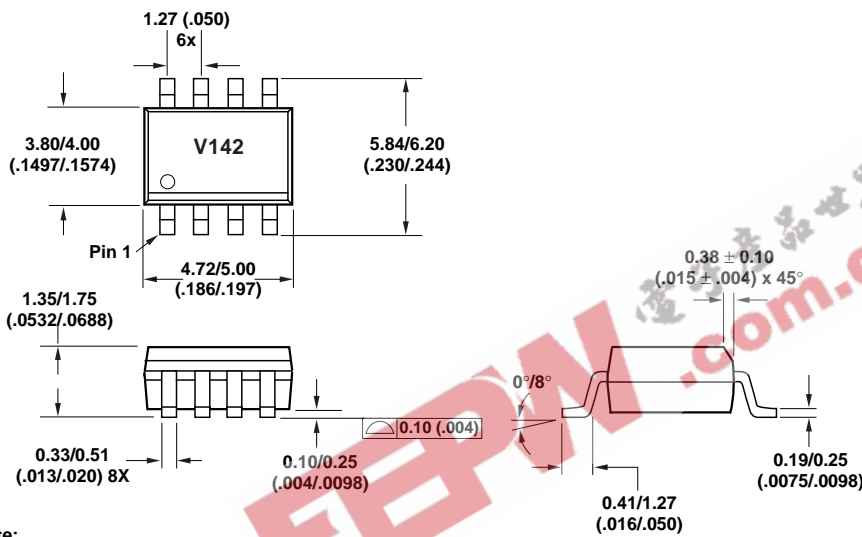

Figure 30. Test Equipment Setup for Measuring Performance of the IVA-142X8.

## IVA-14208, -14228 Part Number Ordering Information

Part Number	Container Type	Qty. per Container
IVA-14208-STR	BIP Strip	1
IVA-14208-TR1	7" Reel	1000
IVA-14228-STR	BIP Strip	1

## SO-8 Package Dimensions for IVA-14208



**Note:**

1. Dimensions are shown in millimeters (inches).

## 28 Package Dimensions for IVA-14228

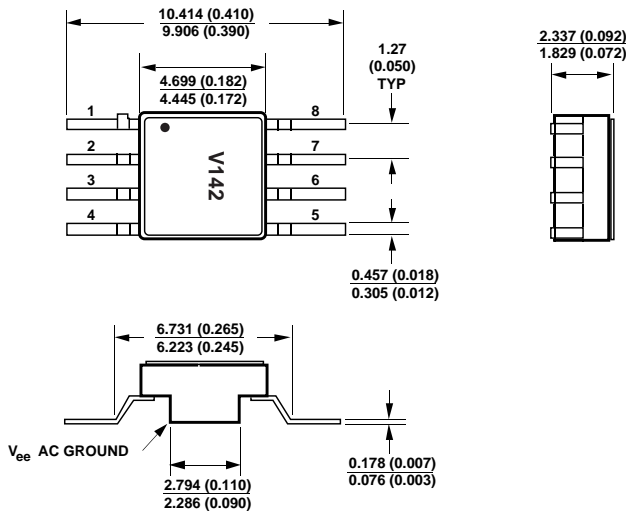

**NOTES:**

1. DIMENSIONS ARE IN MILLIMETERS (INCHES).
2. CONTROLLING DIMENSIONS ARE IN INCHES.