

**IW4081B**

**Quad 2-Input AND Gate**  
**High-Voltage Silicon-Gate CMOS**

The IW4081B AND gates provide the system designer with direct implementation of the AND function.

- Operating Voltage Range: 3.0 to 18 V
- Maximum input current of 1  $\mu$ A at 18 V over full package-temperature range; 100 nA at 18 V and 25°C
- Noise margin (over full package temperature range):
  - 1.0 V min @ 5.0 V supply
  - 2.0 V min @ 10.0 V supply
  - 2.5 V min @ 15.0 V supply

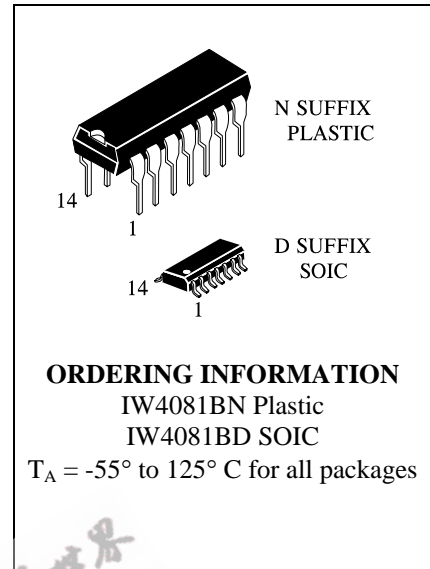

**LOGIC DIAGRAM**

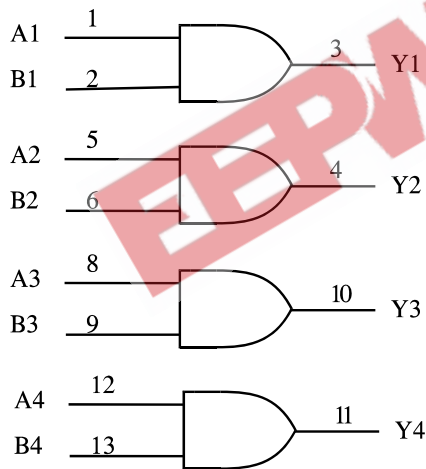

PIN 14 =  $V_{CC}$   
 PIN 7 = GND

**PIN ASSIGNMENT**

A1	1	14	$V_{CC}$
B1	2	13	B4
Y1	3	12	A4
Y2	4	11	Y4
A2	5	10	Y3
B2	6	9	B3
GND	7	8	A3

**FUNCTION TABLE**

Inputs		Output
A	B	Y
L	L	L
L	H	L
H	L	L
H	H	H

**MAXIMUM RATINGS\***

Symbol	Parameter	Value	Unit
V <sub>CC</sub>	DC Supply Voltage (Referenced to GND)	-0.5 to +20	V
V <sub>IN</sub>	DC Input Voltage (Referenced to GND)	-0.5 to V <sub>CC</sub> +0.5	V
V <sub>OUT</sub>	DC Output Voltage (Referenced to GND)	-0.5 to V <sub>CC</sub> +0.5	V
I <sub>IN</sub>	DC Input Current, per Pin	±10	mA
P <sub>D</sub>	Power Dissipation in Still Air, Plastic DIP+ SOIC Package+	750 500	mW
P <sub>D</sub>	Power Dissipation per Output Transistor	100	mW
T <sub>stg</sub>	Storage Temperature	-65 to +150	°C
T <sub>L</sub>	Lead Temperature, 1 mm from Case for 10 Seconds (Plastic DIP or SOIC Package)	260	°C

\*Maximum Ratings are those values beyond which damage to the device may occur. Functional operation should be restricted to the Recommended Operating Conditions.

+Derating - Plastic DIP: - 10 mW/°C from 65° to 125°C

SOIC Package: - 7 mW/°C from 65° to 125°C

**RECOMMENDED OPERATING CONDITIONS**

Symbol	Parameter	Min	Max	Unit
V <sub>CC</sub>	DC Supply Voltage (Referenced to GND)	3.0	18	V
V <sub>IN</sub> , V <sub>OUT</sub>	DC Input Voltage, Output Voltage (Referenced to GND)	0	V <sub>CC</sub>	V
T <sub>A</sub>	Operating Temperature, All Package Types	-55	+125	°C

This device contains protection circuitry to guard against damage due to high static voltages or electric fields. However, precautions must be taken to avoid applications of any voltage higher than maximum rated voltages to this high-impedance circuit. For proper operation, V<sub>IN</sub> and V<sub>OUT</sub> should be constrained to the range GND ≤ (V<sub>IN</sub> or V<sub>OUT</sub>) ≤ V<sub>CC</sub>.

Unused inputs must always be tied to an appropriate logic voltage level (e.g., either GND or V<sub>CC</sub>). Unused outputs must be left open.

## DC ELECTRICAL CHARACTERISTICS (Voltages Referenced to GND)

Symbol	Parameter	Test Conditions	V <sub>CC</sub> V	Guaranteed Limit			Unit
				≥-55°C	25°C	≤125°C	
V <sub>IH</sub>	Minimum High-Level Input Voltage	V <sub>OUT</sub> =0.5V or V <sub>CC</sub> - 0.5V V <sub>OUT</sub> =1.0V or V <sub>CC</sub> - 1.0V V <sub>OUT</sub> =1.5V or V <sub>CC</sub> - 1.5V	5.0	3.5	3.5	3.5	V
			10	7	7	7	
			15	11	11	11	
V <sub>IL</sub>	Maximum Low - Level Input Voltage	V <sub>OUT</sub> =0.5V V <sub>OUT</sub> =1.0V V <sub>OUT</sub> =1.5V	5.0	1.5	1.5	1.5	V
			10	3	3	3	
			15	4	4	4	
V <sub>OH</sub>	Minimum High-Level Output Voltage	V <sub>IN</sub> =V <sub>CC</sub>	5.0	4.95	4.95	4.95	V
			10	9.95	9.95	9.95	
			15	14.95	14.95	14.95	
V <sub>OL</sub>	Maximum Low-Level Output Voltage	V <sub>IN</sub> =GND or V <sub>CC</sub>	5.0	0.05	0.05	0.05	V
			10	0.05	0.05	0.05	
			15	0.05	0.05	0.05	
I <sub>IN</sub>	Maximum Input Leakage Current	V <sub>IN</sub> = GND or V <sub>CC</sub>	18	±0.1	±0.1	±1.0	μA
I <sub>CC</sub>	Maximum Quiescent Supply Current (per Package)	V <sub>IN</sub> = GND or V <sub>CC</sub>	5.0	0.25	0.25	7.5	μA
			10	0.5	0.5	15	
			15	1.0	1.0	30	
			20	5.0	5.0	150	
I <sub>OL</sub>	Minimum Output Low (Sink) Current	V <sub>IN</sub> = GND or V <sub>CC</sub> U <sub>OL</sub> =0.4 V U <sub>OL</sub> =0.5 V U <sub>OL</sub> =1.5 V	5.0	0.64	0.51	0.36	mA
			10	1.6	1.3	0.9	
			15	4.2	3.4	2.4	
I <sub>OH</sub>	Minimum Output High (Source) Current	V <sub>IN</sub> = GND or V <sub>CC</sub> U <sub>OH</sub> =2.5 V U <sub>OH</sub> =4.6 V U <sub>OH</sub> =9.5 V U <sub>OH</sub> =13.5 V	5.0	-2.0	-1.6	-1.15	mA
			5.0	-0.64	-0.51	-0.36	
			10	-1.6	-1.3	-0.9	
			15	-4.2	-3.4	-2.4	

**AC ELECTRICAL CHARACTERISTICS** ( $C_L=50\text{pF}$ ,  $R_L=200\text{k}\Omega$ , Input  $t_r=t_f=20\text{ ns}$ )

Symbol	Parameter	V <sub>CC</sub> V	Guaranteed Limit			Unit
			≥-55°C	25°C	≤125°C	
$t_{PLH}$ , $t_{PHL}$	Maximum Propagation Delay, Input A or B to Output Y (Figure 1)	5.0 10 15	250 120 90	250 120 90	500 240 180	ns
$t_{TLH}$ , $t_{THL}$	Maximum Output Transition Time, Any Output (Figure 1)	5.0 10 15	200 100 80	200 100 80	400 200 160	ns
$C_{IN}$	Maximum Input Capacitance	-		7.5		pF

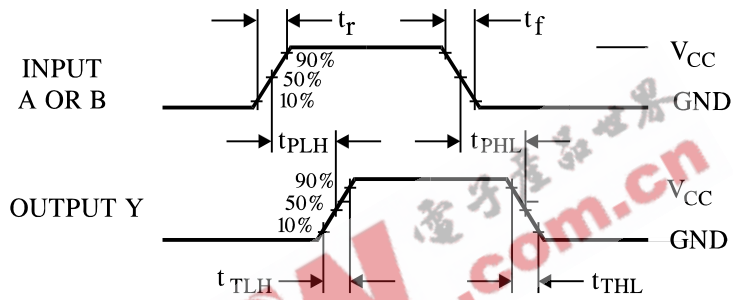
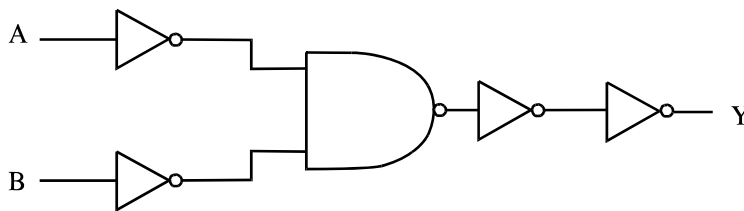
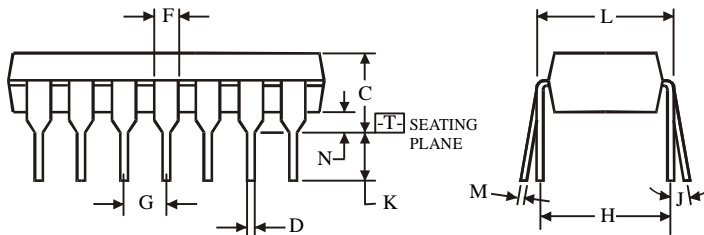
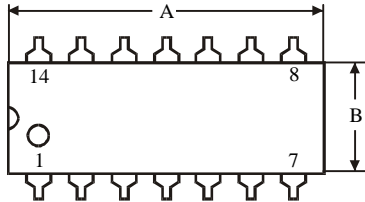
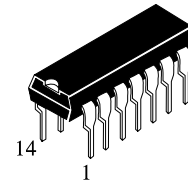

Figure 1. Switching Waveforms

**EXPANDED LOGIC DIAGRAM**  
(1/4 of the Device)



**N SUFFIX PLASTIC DIP**  
**(MS - 001AA)**



$$\oplus 0.25 (0.010) \text{ (M) } T$$

**NOTES:**

- Dimensions "A", "B" do not include mold flash or protrusions.  
Maximum mold flash or protrusions 0.25 mm (0.010) per side.

Dimension, mm		
Symbol	MIN	MAX
A	18.67	19.69
B	6.1	7.11
C		5.33
D	0.36	0.56
F	1.14	1.78
G	2.54	
H	7.62	
J	0°	10°
K	2.92	3.81
L	7.62	8.26
M	0.2	0.36
N	0.38	

**D SUFFIX SOIC**  
**(MS - 012AB)**

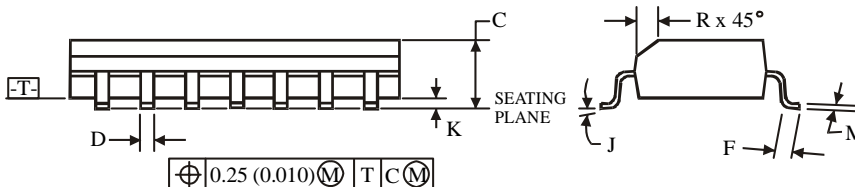
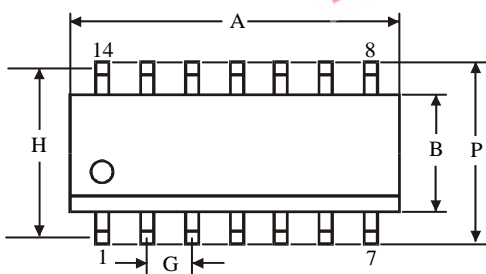
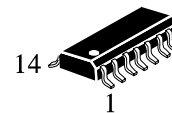

$$\oplus 0.25 (0.010) \text{ (M) } T \text{ C (M)}$$

**NOTES:**

- Dimensions A and B do not include mold flash or protrusion.
- Maximum mold flash or protrusion 0.15 mm (0.006) per side for A; for B - 0.25 mm (0.010) per side.

Dimension, mm		
Symbol	MIN	MAX
A	8.55	8.75
B	3.8	4
C	1.35	1.75
D	0.33	0.51
F	0.4	1.27
G	1.27	
H	5.27	
J	0°	8°
K	0.1	0.25
M	0.19	0.25
P	5.8	6.2
R	0.25	0.5