

Part Number	Description
TS24D2G	2A, 275 Vac
TS3R2G	2.5A, 30 Vdc
TS3R1G	1A, 30 Vac/Vdc

**Part Number Explanation**

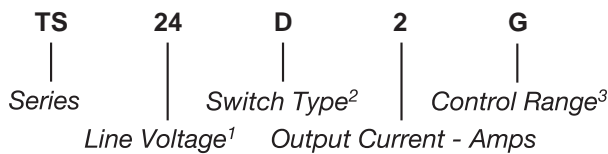

**NOTES**

- 1) Line Voltage (nominal): 24 = 240 Vac;  
3 = 30 Vdc (3–30 Vdc/Vac for TS3R1G)
- 2) Switch Type: D = Zero-cross turn-on; R = Random turn-on
- 3) Control Range: G = 12–30 Vdc/Vac (TS242G, TS3R1G)  
G = 12–30 Vdc (TS3R2G)

**MECHANICAL SPECIFICATION**

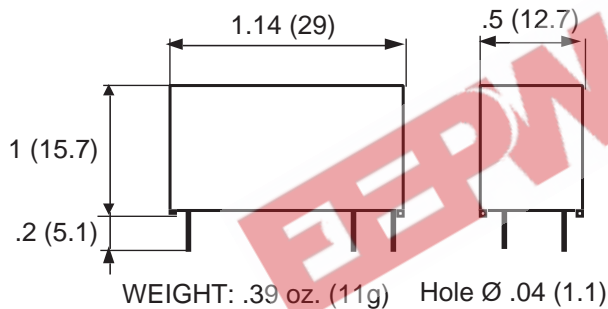

Figure 1 — TS relays; dimensions in inches (mm)

**INPUT (CONTROL) SPECIFICATION**

	Min	Max	Units
Control Range			
TS242G, TS3R1G	12	30	Vac/Vdc
TS3R2G	12	30	Vdc
Input Current Range	4.1	13	mA
(See Figure 2)			
Must Turn-Off Voltage		2.5	V
Input Resistance (Typical)		2100	Ohms



**FEATURES/BENEFITS**

- Pin-to-pin compatible with electromechanical relays
- AC and DC control
- AC and DC output
- Random and zero-cross turn-on
- Compact size
- High inrush capabilities
- Integrated clamping voltage

**DESCRIPTION**

The Series TS relays provide AC/DC switching in a compact size. The TS relays also provide an AC/DC control. These relays can withstand high surge currents. The TS relays are pin-to-pin compatible with electromechanical relays and may be used as replacements.

**APPLICATIONS**

- Interface applications
- Vending machines
- Light/lamp control
- Contactor driver
- Fan speed control

**APPROVALS**

All models are UL recognized.  
UL File Number E128555.

**CONTROL CHARACTERISTIC**

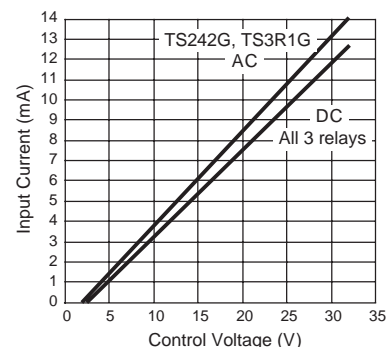

Figure 2 — TS Relays

**BLOCK DIAGRAM**

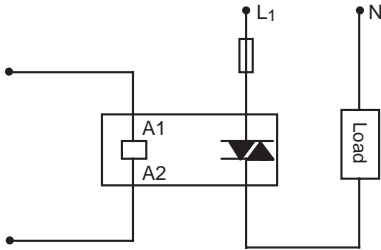

Figure 3a — TS24D2G

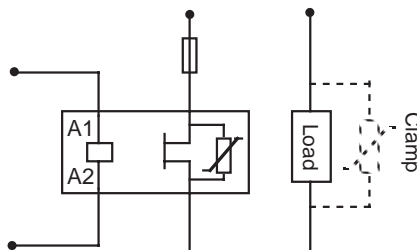

Figure 3b — TS3R1G

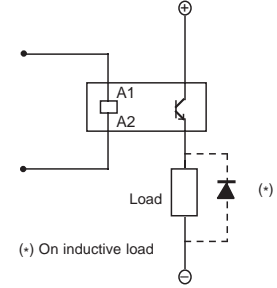

Figure 3c — TS3R2G

**GRID DIAGRAM**

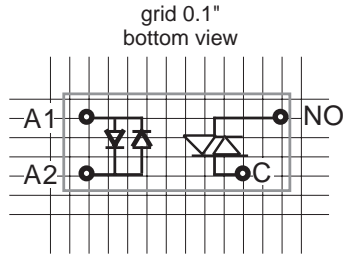

Figure 4a — TS24D2G

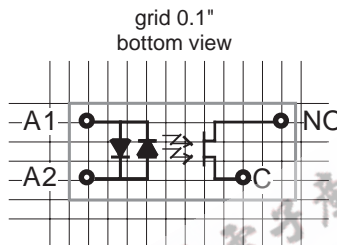

Figure 4b — TS3R1G

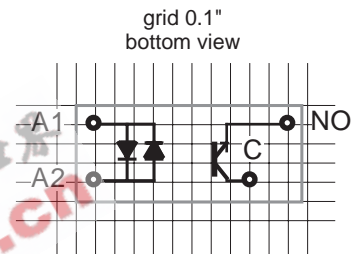

Figure 4c — TS3R2G

**OUTPUT (LOAD) SPECIFICATION**

	Min	Max	Unit
Operating Range			
TS24D2G	12	275	Vrms
TS3R2G	0	30	Vdc
TS3R1G	0	30	Vac/Vdc

Peak Voltage	Min	Max	Unit
TS24D2G		600	V
TS3R2G		60	V
TS3R1G		60	V

Load Current Range	Min	Max	Unit
TS24D2G	.05	2	Arms
TS3R2G	.001	2.5	Arms
TS3R1G	.001	1	Arms

Maximum Surge Current Rating (Non-Repetitive) (See Figure 6)	Min	Max	Unit
TS24D2G		100	A
TS3R2G		12	A
TS3R1G		2.4	A

**OUTPUT (LOAD) SPECIFICATION (Continued)**

On-State Voltage Drop	Min	Max	Unit
TS24D2G		1.0	V
TS3R2G		0.5	V
TS3R1G		0.9	V

Zero-Cross Window (Typical)	Min	Max	Unit
TS24D2G		±10	V
TS3R2G		NA	
TS3R1G		NA	

Off-State Leakage Current (60Hz)	Min	Max	Unit
All relays		1	mA

Operating Frequency Range	Min	Max	Unit
TS24D2G	1	440	Hz
TS3R1G	0	50	KHz

Turn-On Time (60Hz)	Min	Max	Unit
TS24D2G		10	ms
TS3R2G		50	µs
TS3R1G		5	ms

**OUTPUT (LOAD) SPECIFICATION (Continued)**

	Min	Max	Unit
Turn-Off Time (60Hz)			
TS24D2G		17	ms
TS3R2G		600	μs
TS3R1G		10	ms

Off-State dv/dt			
TS24D2G		500	V/μs

Switching Frequency			
TS3R2G		100	Hz
TS3R1G		10	Hz

I <sup>2</sup> t for Match Fusing (<8.3ms)			
TS24D2G		50	A <sup>2</sup> S

**ENVIRONMENTAL SPECIFICATION**

	Min	Max	Unit
Maximum Junction Temperature		125	°C
Operating Temperature			
TS24D2G	-40	100	°C
TS3R2G	-40	100	°C
TS3R1G	-40	90	°C

Input-Output Isolation			
TS24D2G	4000		V
TS3R2G	2500		V
TS3R1G	4000		V

Junction-Case Thermal Resistance			
TS24D2G		12	°C/W
TS3R2G		12	°C/W
TS3R1G		44	°C/W

Junction-Ambient Thermal Resistance			
TS24D2G		44	°C/W
TS3R2G		44	°C/W
TS3R1G		88	°C/W

Maximum Soldering Heat (1mm case)	260	°C
-----------------------------------	-----	----

**THERMAL CURVE**

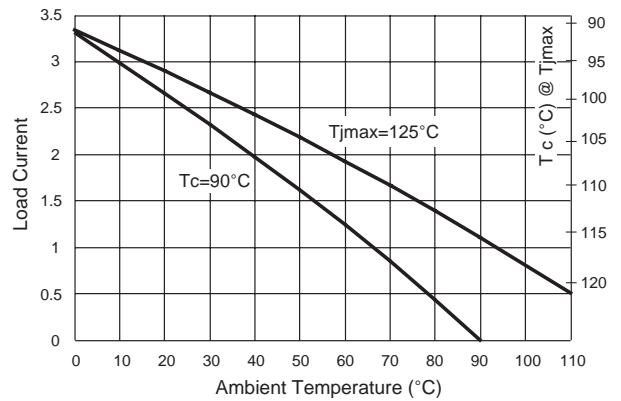

Figure 5a — TS24D2G

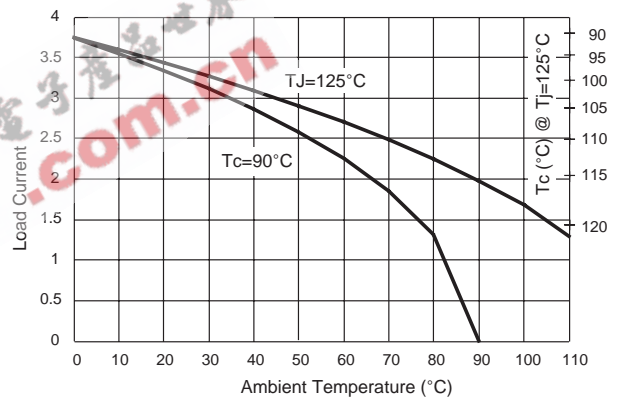

Figure 5b — TS3R2G

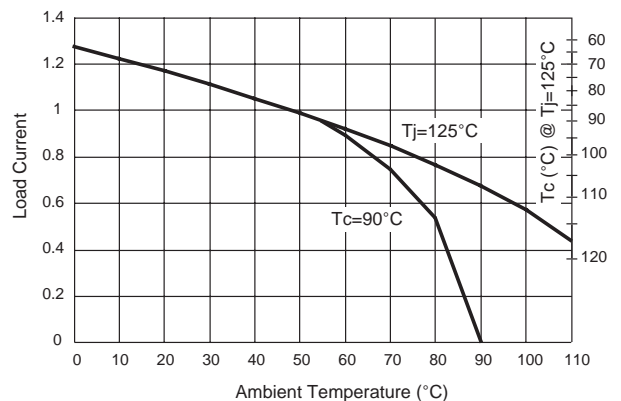

Figure 5c — TS3R1G

**NON-REPETITIVE SURGE CURRENT**

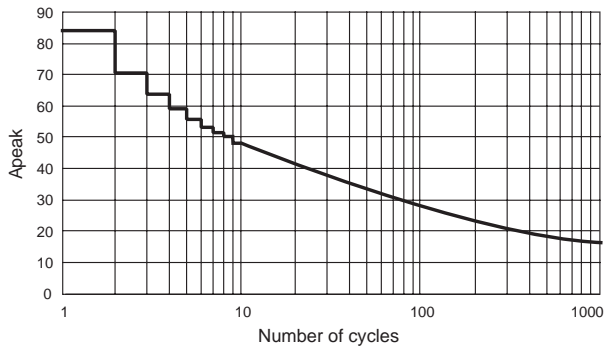

Figure 6a — TS24D2G

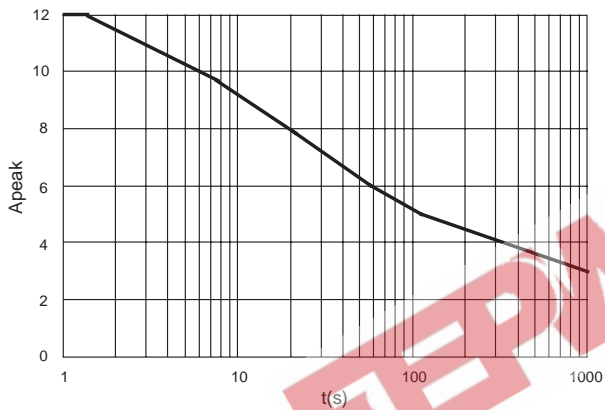

Figure 6b — TS3R2G

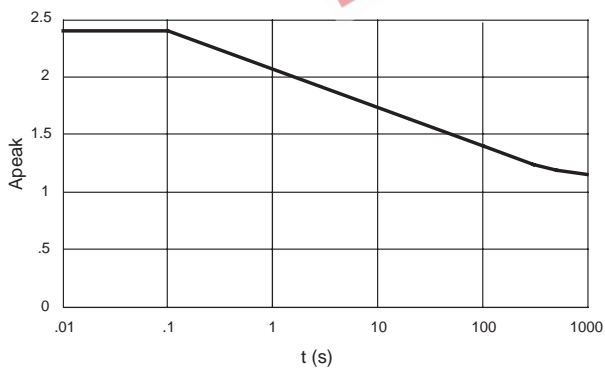

Figure 6c — TS3R1G

**NOTES:**

1. On inductive loads, a free-wheeling diode (or clamp) is recommended.
2. Electrical specifications at 25°C unless otherwise specified.
3. TS3R2G no polarity on the control pins.
4. For additional/custom options, contact factory.