

2.85 TO 12 VOLT FIXED POSITIVE LOCAL VOLTAGE REGULATOR

ISSUE 3 - DECEMBER 2001

ZR78L SERIES

DEVICE DESCRIPTION

The ZR78L Series three terminal fixed positive voltage regulators feature internal circuit current limit and thermal shutdown making the devices difficult to destroy. The circuit design allows creation of any custom voltage in the range 2.85 to 12 volts. The devices are available in a small outline surface mount package, ideal for applications where space saving is important, as well as through hole TO92 style packaging. The devices are suited to local voltage regulation applications, where problems could be encountered with distributed single source regulation, as well as more general voltage regulation applications.

The ZR78L Series show performance characteristics superior to other local voltage regulators. The initial output voltage is maintained to within 2.5% with a quiescent current of typically 350 μ A. Output voltage change, with input voltage and load current, is much lower than competitive devices. The ZR78L devices are completely stable with no external components. The device will shut down under thermal overload conditions but as the device cools, regulation will restart.

FEATURES

- Small outline SOT223 package
- SO8 package (3.3V and 5.0V)
- TO92 package
- 2.85 to 12 Volt
- Output current up to 200mA
- Tight initial tolerance
- Low quiescent current
- -55 to 125°C temperature range
- No external components
- Internal thermal shutdown
- Internal short circuit current limit

VOLTAGE RANGE

ZR78L028	2.85V
ZR78L03	3.0V
ZR78L033	3.3V
ZR78L04	4.0V
ZR78L048	4.85V
ZR78L05	5.0V
ZR78L052	5.2V
ZR78L057	5.7V
ZR78L06	6.0V
ZR78L07	7.0V
ZR78L08	8.0V
ZR78L085	8.5V
ZR78L09	9.0V
ZR78L10	10.0V
ZR78L12	12.0V

ZR78L SERIES

ABSOLUTE MAXIMUM RATING

Input voltage	20V
Output Current(I _o)	200mA
Operating Temperature	-55 to 125°C
Storage Temperature	-65 to 150°C

Power Dissipation (T_{amb}=25°C)	
SOT223	2W(Note 3)
TO92	600mW
S08	780mW(Note 3)

ELECTRICAL CHARACTERISTICS:

Notes:

1. The maximum operating input voltage and output current of the device will be governed by the maximum power dissipation of the selected package. Maximum package power dissipation is specified at 25 °C and must be linearly derated to zero at T_{amb}=125°C.
2. The following data represents pulse test conditions with junction temperatures as indicated at the initiation of the test. Continuous operation of the devices with the stated conditions might exceed the power dissipation limits of the chosen package.

3. Maximum power dissipation, for the SOT223 and SO8 packages, is calculated assuming that the device is mounted on a PCB measuring 2 inches square.
4. The shut down feature of the device operates if its temperature exceeds its design limit as might occur during external faults, short circuits etc. If the regulator is supplied from an inductive source then a large voltage transient, on the regulator input, can result should the shut down circuit operate. It is advised that a capacitor (1μF or greater) should be applied across the regulator input to ensure that the maximum voltage rating of the device is not exceeded under shutdown conditions.

ZR78L028 TEST CONDITIONS (Unless otherwise stated):T_j=25°C, I_O=100mA, V_{in}=6.85V

SYMBOL	PARAMETER	CONDITIONS	MIN.	TYP.	MAX.	UNITS
V _O	Output Voltage		2.78	2.85	2.92	V
		I _O =1 to 200mA τ	2.736		2.964	V
		V _{in} =4.85 to 20V I _O =1 to 100mA τ	2.736		2.964	V
ΔV _O	Line Regulation	V _{in} =4.85 to 20V		10	40	mV
ΔV _O	Load Regulation	I _O =1 to 200mA		5	25	mV
		I _O =1 to 100mA		2		mV
I _q	Quiescent Current	τ		350	600	μA
ΔI _q	Quiescent Current Change	I _O =1 to 200mA V _{in} =4.85 to 20V			100 100	μA μA
V _n	Output Noise Voltage	f=10Hz to 10kHz		75		μV rms
ΔV _{in} /ΔV _O	Ripple Rejection	V _{in} =5.85 to 18V f=120Hz	48	62		dB
V _{in}	Input Voltage Required To Maintain Regulation		4.85	4.55		V
ΔV _O /ΔT	Average Temperature Coefficient of V _O	I _O =5.0mA τ		0.1		mV/°C

τ=T_j=-55 to 125°C

ZR78L SERIES

ZR78L03 TEST CONDITIONS (Unless otherwise stated): $T_j=25^{\circ}\text{C}$, $I_O=100\text{mA}$, $V_{in}=7\text{V}$

SYMBOL	PARAMETER	CONDITIONS	MIN.	TYP.	MAX.	UNITS
V_O	Output Voltage		2.92	3.0	3.08	V
		$I_O=1$ to 200mA τ	2.88		3.12	V
		$V_{in}=5$ to 20V $I_O=1$ to 100mA τ	2.88		3.12	V
ΔV_O	Line Regulation	$V_{in}=5$ to 20V		10	40	mV
ΔV_O	Load Regulation	$I_O=1$ to 200mA		5	25	mV
		$I_O=1$ to 100mA		2		mV
I_q	Quiescent Current	τ		350	600	μA
ΔI_q	Quiescent Current Change	$I_O=1$ to 200mA			100	μA
		$V_{in}=5$ to 20V			100	μA
V_n	Output Noise Voltage	$f=10\text{Hz}$ to 10kHz		75		$\mu\text{V rms}$
$\Delta V_{in}/\Delta V_O$	Ripple Rejection	$V_{in}=6$ to 18V $f=120\text{Hz}$	48	62		dB
V_{in}	Input Voltage Required To Maintain Regulation		5	4.7		V
$\Delta V_O/\Delta T$	Average Temperature Coefficient of V_O	$I_O=5.0\text{mA}$ τ		0.1		mV/ $^{\circ}\text{C}$

ZR78L033 TEST CONDITIONS (Unless otherwise stated): $T_j=25^{\circ}\text{C}$, $I_O=100\text{mA}$, $V_{in}=7.3\text{V}$

SYMBOL	PARAMETER	CONDITIONS	MIN.	TYP.	MAX.	UNITS
V_O	Output Voltage		3.218	3.3	3.382	V
		$I_O=1$ to 200mA τ	3.168		3.432	V
		$V_{in}=5.3$ to 20V $I_O=1$ to 100mA τ	3.168		3.432	V
ΔV_O	Line Regulation	$V_{in}=5.3$ to 20V		7.5	30	mV
ΔV_O	Load Regulation	$I_O=1$ to 200mA		5	25	mV
		$I_O=1$ to 100mA		2		mV
I_q	Quiescent Current	τ		350	600	μA
ΔI_q	Quiescent Current Change	$I_O=1$ to 200mA			100	μA
		$V_{in}=5.3$ to 20V			100	μA
V_n	Output Noise Voltage	$f=10\text{Hz}$ to 10kHz		50		$\mu\text{V rms}$
$\Delta V_{in}/\Delta V_O$	Ripple Rejection	$V_{in}=6.3$ to 18V $f=120\text{Hz}$	50	64		dB
V_{in}	Input Voltage Required To Maintain Regulation		5.3	5		V
$\Delta V_O/\Delta T$	Average Temperature Coefficient of V_O	$I_O=5.0\text{mA}$ τ		0.1		mV/ $^{\circ}\text{C}$

$\tau = T_j = -55$ to 125°C

ZR78L SERIES

ZR78L04 TEST CONDITIONS (Unless otherwise stated): $T_j=25^{\circ}\text{C}$, $I_O=100\text{mA}$, $V_{in}=8\text{V}$

SYMBOL	PARAMETER	CONDITIONS	MIN.	TYP.	MAX.	UNITS
V_O	Output Voltage		3.9	4.0	4.1	V
		$I_O=1$ to 200mA τ	3.84		4.16	V
		$V_{in}=6$ to 20V $I_O=1$ to 100mA τ	3.84		4.16	V
ΔV_O	Line Regulation	$V_{in}=6$ to 20V		10	40	mV
ΔV_O	Load Regulation	$I_O=1$ to 200mA		5	25	mV
		$I_O=1$ to 100mA		2		mV
I_q	Quiescent Current	τ		350	600	μA
ΔI_q	Quiescent Current Change	$I_O=1$ to 200mA			100	μA
		$V_{in}=6$ to 20V			100	μA
V_n	Output Noise Voltage	$f=10\text{Hz}$ to 10kHz		75		$\mu\text{V rms}$
$\Delta V_{in}/\Delta V_O$	Ripple Rejection	$V_{in}=7$ to 18V $f=120\text{Hz}$	48	62		dB
V_{in}	Input Voltage Required To Maintain Regulation		6	5.3		V
$\Delta V_O/\Delta T$	Average Temperature Coefficient of V_O	$I_O=5.0\text{mA}$ τ		0.1		$\text{mV}/^{\circ}\text{C}$

ZR78L048 TEST CONDITIONS (Unless otherwise stated): $T_j=25^{\circ}\text{C}$, $I_O=100\text{mA}$, $V_{in}=8.85\text{V}$

SYMBOL	PARAMETER	CONDITIONS	MIN.	TYP.	MAX.	UNITS
V_O	Output Voltage		4.729	4.85	4.971	V
		$I_O=1$ to 200mA τ	4.656		5.044	V
		$V_{in}=6.8$ to 20V $I_O=1$ to 100mA τ	4.656		5.044	V
ΔV_O	Line Regulation	$V_{in}=6.85$ to 20V		10	40	mV
ΔV_O	Load Regulation	$I_O=1$ to 200mA		5	25	mV
		$I_O=1$ to 100mA		2		mV
I_q	Quiescent Current	τ		350	600	μA
ΔI_q	Quiescent Current Change	$I_O=1$ to 200mA			100	μA
		$V_{in}=6.85$ to 20V			100	μA
V_n	Output Noise Voltage	$f=10\text{Hz}$ to 10kHz		50		$\mu\text{V rms}$
$\Delta V_{in}/\Delta V_O$	Ripple Rejection	$V_{in}=7.85$ to 18V $f=120\text{Hz}$	50	64		dB
V_{in}	Input Voltage Required To Maintain Regulation		6.85	6.55		V
$\Delta V_O/\Delta T$	Average Temperature Coefficient of V_O	$I_O=5.0\text{mA}$ τ		0.1		$\text{mV}/^{\circ}\text{C}$

$\tau = T_j = -55$ to 125°C

ZR78L SERIES

ZR78L10 TEST CONDITIONS (Unless otherwise stated): $T_j=25^{\circ}\text{C}$, $I_O=100\text{mA}$, $V_{in}=14\text{V}$

SYMBOL	PARAMETER	CONDITIONS	MIN.	TYP.	MAX.	UNITS
V_O	Output Voltage		9.75	10	10.25	V
		$I_O=1$ to 200mA τ	9.6		10.4	V
		$V_{in}=12$ to 20V $I_O=1$ to 100mA τ	9.6		10.4	V
ΔV_O	Line Regulation	$V_{in}=12$ to 20V		12	40	mV
ΔV_O	Load Regulation	$I_O=1$ to 200mA $I_O=1$ to 100mA		9	30	mV
				3		mV
I_q	Quiescent Current	τ		350	600	μA
ΔI_q	Quiescent Current Change	$I_O=1$ to 200mA $V_{in}=12$ to 20V			100	μA
					100	μA
V_n	Output Noise Voltage	$f=10\text{Hz}$ to 10kHz		150		$\mu\text{V rms}$
$\Delta V_{in}/\Delta V_O$	Ripple Rejection	$V_{in}=13$ to 18V $f=120\text{Hz}$	43	57		dB
V_{in}	Input Voltage Required To Maintain Regulation		12	11.7		V
$\Delta V_O/\Delta T$	Average Temperature Coefficient of V_O	$I_O=5.0\text{mA}$ τ		0.25		$\text{mV}/^{\circ}\text{C}$

ZR78L12 TEST CONDITIONS (Unless otherwise stated): $T_j=25^{\circ}\text{C}$, $I_O=100\text{mA}$, $V_{in}=16\text{V}$

SYMBOL	PARAMETER	CONDITIONS	MIN.	TYP.	MAX.	UNITS
V_O	Output Voltage		11.7	12	12.3	V
		$I_O=1$ to 200mA τ	11.52		12.48	V
		$V_{in}=14$ to 20V $I_O=1$ to 100mA τ	11.52		12.48	V
ΔV_O	Line Regulation	$V_{in}=14$ to 20V		12	40	mV
ΔV_O	Load Regulation	$I_O=1$ to 200mA $I_O=1$ to 100mA		9	30	mV
				3		mV
I_q	Quiescent Current	τ		350	600	μA
ΔI_q	Quiescent Current Change	$I_O=1$ to 200mA $V_{in}=14$ to 20V			100	μA
					100	μA
V_n	Output Noise Voltage	$f=10\text{Hz}$ to 10kHz		150		$\mu\text{V rms}$
$\Delta V_{in}/\Delta V_O$	Ripple Rejection	$V_{in}=15$ to 18V $f=120\text{Hz}$	43	57		dB
V_{in}	Input Voltage Required To Maintain Regulation		14	13.7		V
$\Delta V_O/\Delta T$	Average Temperature Coefficient of V_O	$I_O=5.0\text{mA}$ τ		0.25		$\text{mV}/^{\circ}\text{C}$

$\tau = T_j = -55$ to 125°C

ZR78L028 ZR78L03
 ZR78L04 ZR78L057
 ZR78L09

**ZR78L
 SERIES**

TYPICAL CHARACTERISTICS

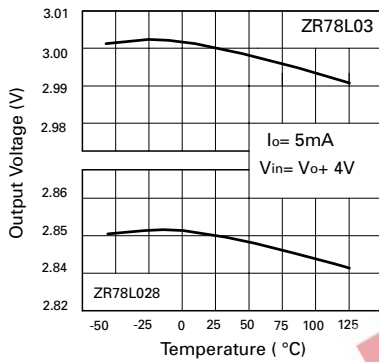

Output Voltage Temperature Coefficient

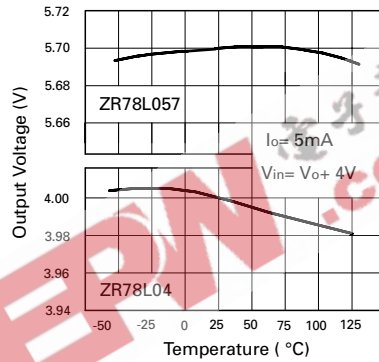

Output Voltage Temperature Coefficient

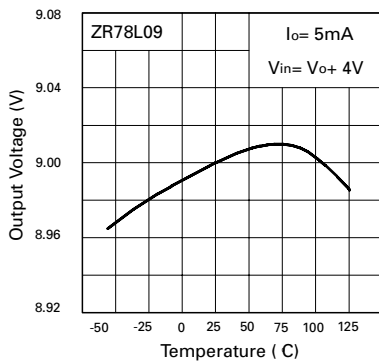

Output Voltage Temperature Coefficient

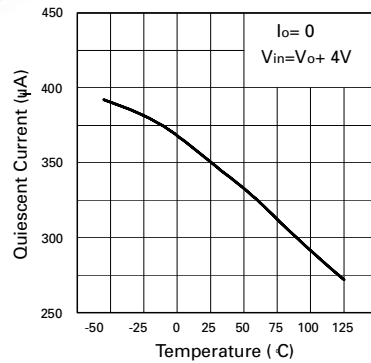

Quiescent Current vs. Temperature

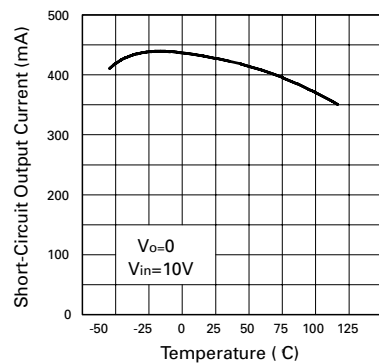

Peak Output Current vs. Temperature

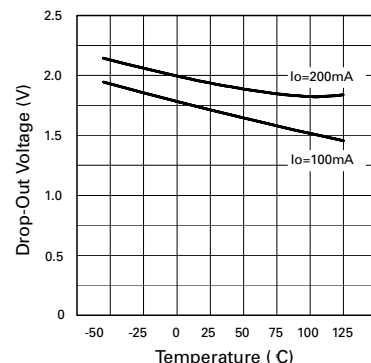

Drop-Out Voltage vs. Temperature

ZR78L033 ZR78L05
 ZR78L06 ZR78L08
 ZR78L10

**ZR78L
 SERIES**

TYPICAL CHARACTERISTICS

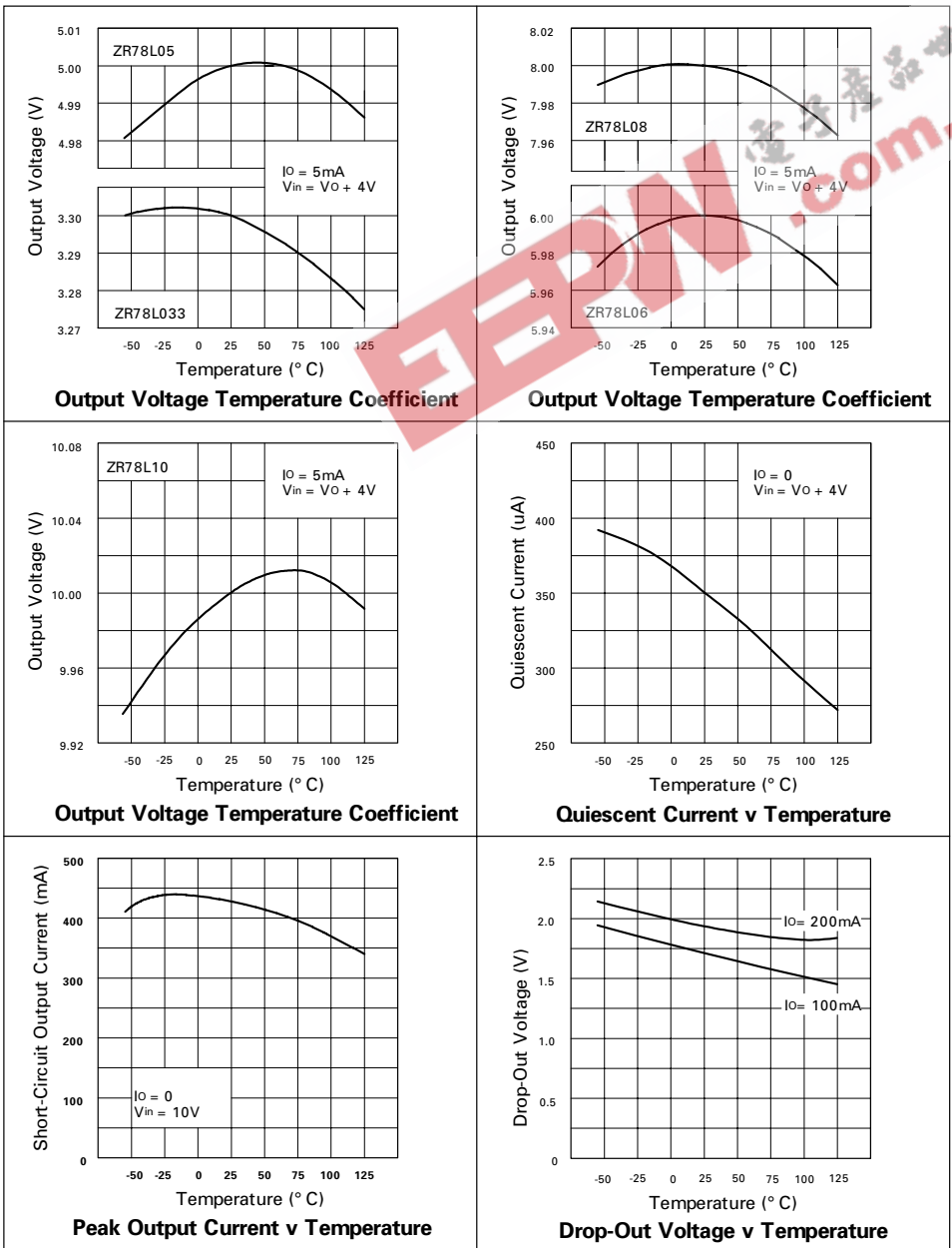

ZR78L SERIES

ZR78L057 TEST CONDITIONS (Unless otherwise stated): $T_j=25^{\circ}\text{C}$, $I_O=100\text{mA}$, $V_{in}=9.7\text{V}$

SYMBOL	PARAMETER	CONDITIONS	MIN.	Typ.	MAX.	UNITS
V_O	Output Voltage		5.557	5.7	5.843	V
		$I_O=1$ to 200mA τ	5.47		5.93	V
		$V_{in}=7.7$ to 20V $I_O=1$ to 100mA τ	5.47		5.93	V
ΔV_O	Line Regulation	$V_{in}=7.7$ to 20V		10	40	mV
ΔV_O	Load Regulation	$I_O=1$ to 200mA $I_O=1$ to 100mA		7 2.5	30	mV mV
I_q	Quiescent Current	τ		350	600	μA
ΔI_q	Quiescent Current Change	$I_O=1$ to 200mA $V_{in}=7.7$ to 20V			100 100	μA μA
V_n	Output Noise Voltage	$f=10\text{Hz}$ to 10kHz		90		$\mu\text{V rms}$
$\Delta V_{in}/\Delta V_O$	Ripple Rejection	$V_{in}=8.7$ to 18V $f=120\text{Hz}$	48	62		dB
V_{in}	Input Voltage Required To Maintain Regulation		7.7	7.4		V
$\Delta V_O/\Delta T$	Average Temperature Coefficient of V_O	$I_O=5.0\text{mA}$ τ		0.15		$\text{mV}/^{\circ}\text{C}$

ZR78L06 TEST CONDITIONS (Unless otherwise stated): $T_j=25^{\circ}\text{C}$, $I_O=100\text{mA}$, $V_{in}=10\text{V}$

SYMBOL	PARAMETER	CONDITIONS	MIN.	TYP.	MAX.	UNITS
V_O	Output Voltage		5.85	6	6.15	V
		$I_O=1$ to 200mA τ	5.76		6.24	V
		$V_{in}=8$ to 20V $I_O=1$ to 100mA τ	5.76		6.24	V
ΔV_O	Line Regulation	$V_{in}=8$ to 20V		10	40	mV
ΔV_O	Load Regulation	$I_O=1$ to 200mA $I_O=1$ to 100mA		7 2.5	30	mV mV
I_q	Quiescent Current	τ		350	600	μA
ΔI_q	Quiescent Current Change	$I_O=1$ to 200mA $V_{in}=8$ to 20V			100 100	μA μA
V_n	Output Noise Voltage	$f=10\text{Hz}$ to 10kHz		90		$\mu\text{V rms}$
$\Delta V_{in}/\Delta V_O$	Ripple Rejection	$V_{in}=9$ to 18V $f=120\text{Hz}$	48	62		dB
V_{in}	Input Voltage Required To Maintain Regulation		8	7.7		V
$\Delta V_O/\Delta T$	Average Temperature Coefficient of V_O	$I_O=5.0\text{mA}$ τ		0.15		$\text{mV}/^{\circ}\text{C}$

$\tau = T_j = -55$ to 125°C

ZR78L SERIES

ZR78L05 TEST CONDITIONS (Unless otherwise stated): $T_j=25^{\circ}\text{C}$, $I_O=100\text{mA}$, $V_{in}=9\text{V}$

SYMBOL	PARAMETER	CONDITIONS	MIN.	TYP.	MAX.	UNITS
V_O	Output Voltage		4.875	5	5.125	V
		$I_O=1$ to 200mA τ	4.8		5.2	V
		$V_{in}=7$ to 20V $I_O=1$ to 100mA τ	4.8		5.2	V
ΔV_O	Line Regulation	$V_{in}=7$ to 20V		10	40	mV
ΔV_O	Load Regulation	$I_O=1$ to 200mA		5	25	mV
		$I_O=1$ to 100mA		2		mV
I_q	Quiescent Current	τ		350	600	μA
ΔI_q	Quiescent Current Change	$I_O=1$ to 200mA			100	μA
		$V_{in}=7$ to 20V			100	μA
V_n	Output Noise Voltage	$f=10\text{Hz}$ to 10kHz		75		$\mu\text{V rms}$
$\Delta V_{in}/\Delta V_O$	Ripple Rejection	$V_{in}=8$ to 18V $f=120\text{Hz}$	48	62		dB
V_{in}	Input Voltage Required To Maintain Regulation		7	6.7		V
$\Delta V_O/\Delta T$	Average Temperature Coefficient of V_O	$I_O=5.0\text{mA}$ τ		0.1		mV/ $^{\circ}\text{C}$

ZR78L052 TEST CONDITIONS (Unless otherwise stated): $T_j=25^{\circ}\text{C}$, $I_O=100\text{mA}$, $V_{in}=9.2\text{V}$

SYMBOL	PARAMETER	CONDITIONS	MIN.	TYP.	MAX.	UNITS
V_O	Output Voltage		5.070	5.2	5.330	V
		$I_O=1$ to 200mA τ	4.99		5.41	V
		$V_{in}=7.2$ to 20V $I_O=1$ to 100mA τ	4.99		5.41	V
ΔV_O	Line Regulation	$V_{in}=7.2$ to 20V		10	40	mV
ΔV_O	Load Regulation	$I_O=1$ to 200mA		5	25	mV
		$I_O=1$ to 100mA		2		mV
I_q	Quiescent Current	τ		350	600	μA
ΔI_q	Quiescent Current Change	$I_O=1$ to 200mA			100	μA
		$V_{in}=7.2$ to 20V			100	μA
V_n	Output Noise Voltage	$f=10\text{Hz}$ to 10kHz		75		$\mu\text{V rms}$
$\Delta V_{in}/\Delta V_O$	Ripple Rejection	$V_{in}=8.2$ to 18V $f=120\text{Hz}$	48	62		dB
V_{in}	Input Voltage Required To Maintain Regulation		7.2	6.9		V
$\Delta V_O/\Delta T$	Average Temperature Coefficient of V_O	$I_O=5.0\text{mA}$ τ		0.1		mV/ $^{\circ}\text{C}$

$\tau = T_j = -55$ to 125°C

ZR78L SERIES

ZR78L085 TEST CONDITIONS (Unless otherwise stated): $T_j=25^{\circ}\text{C}$, $I_O=100\text{mA}$, $V_{in}=12.5\text{V}$

SYMBOL	PARAMETER	CONDITIONS	MIN.	TYP.	MAX.	UNITS
V_O	Output Voltage		8.288	8.5	8.712	V
		$I_O=1$ to 200mA τ	8.16		8.84	V
		$V_{in}=10$ to 20V $I_O=1$ to 100mA τ	8.16		8.84	V
ΔV_O	Line Regulation	$V_{in}=10.5$ to 20V		11	40	mV
ΔV_O	Load Regulation	$I_O=1$ to 200mA		8	30	mV
		$I_O=1$ to 100mA		3		mV
I_q	Quiescent Current	τ		350	600	μA
ΔI_q	Quiescent Current Change	$I_O=1$ to 200mA			100	μA
		$V_{in}=10.5$ to 20V			100	μA
V_n	Output Noise Voltage	$f=10\text{Hz}$ to 10kHz		115		$\mu\text{V rms}$
$\Delta V_{in}/\Delta V_O$	Ripple Rejection	$V_{in}=11.5$ to 18V $f=120\text{Hz}$	44	60		dB
V_{in}	Input Voltage Required To Maintain Regulation		10.5	10.2		V
$\Delta V_O/\Delta T$	Average Temperature Coefficient of V_O	$I_O=5.0\text{mA}$ τ		0.25		$\text{mV}/^{\circ}\text{C}$

ZR78L09 TEST CONDITIONS (Unless otherwise stated): $T_j=25^{\circ}\text{C}$, $I_O=100\text{mA}$, $V_{in}=13\text{V}$

SYMBOL	PARAMETER	CONDITIONS	MIN.	TYP.	MAX.	UNITS
V_O	Output Voltage		8.775	9.0	9.225	V
		$I_O=1$ to 200mA τ	8.64		9.36	V
		$V_{in}=11$ to 20V $I_O=1$ to 100mA τ	8.64		9.36	V
ΔV_O	Line Regulation	$V_{in}=11$ to 20V		12	40	mV
ΔV_O	Load Regulation	$I_O=1$ to 200mA		9	30	mV
		$I_O=1$ to 100mA		3		mV
I_q	Quiescent Current	τ		350	600	μA
ΔI_q	Quiescent Current Change	$I_O=1$ to 200mA			100	μA
		$V_{in}=11$ to 20V			100	μA
V_n	Output Noise Voltage	$f=10\text{Hz}$ to 10kHz		150		$\mu\text{V rms}$
$\Delta V_{in}/\Delta V_O$	Ripple Rejection	$V_{in}=12$ to 18V $f=120\text{Hz}$	43	57		dB
V_{in}	Input Voltage Required To Maintain Regulation		11	10.7		V
$\Delta V_O/\Delta T$	Average Temperature Coefficient of V_O	$I_O=5.0\text{mA}$ τ		0.25		$\text{mV}/^{\circ}\text{C}$

$\tau = T_j = -55$ to 125°C

ZR78L SERIES

ZR78L028 ZR78L03
ZR78L04 ZR78L057
ZR78L09

TYPICAL CHARACTERISTICS

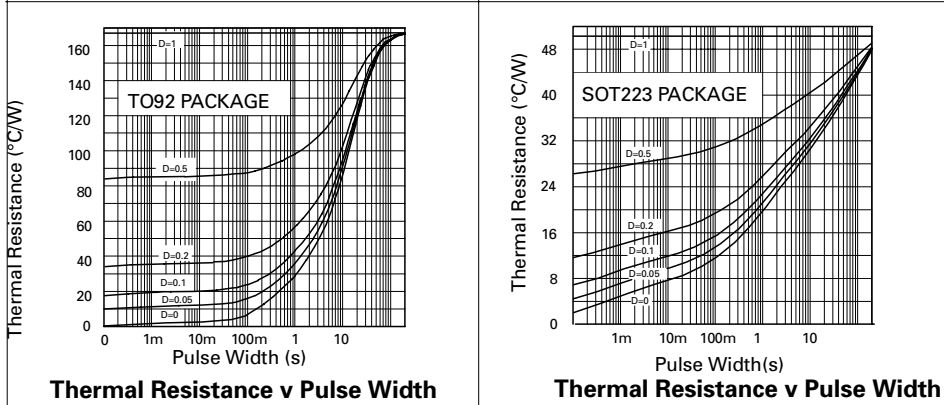
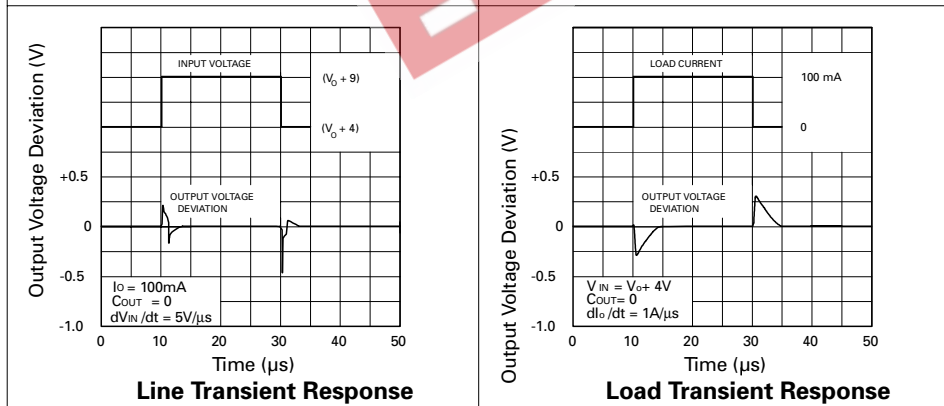
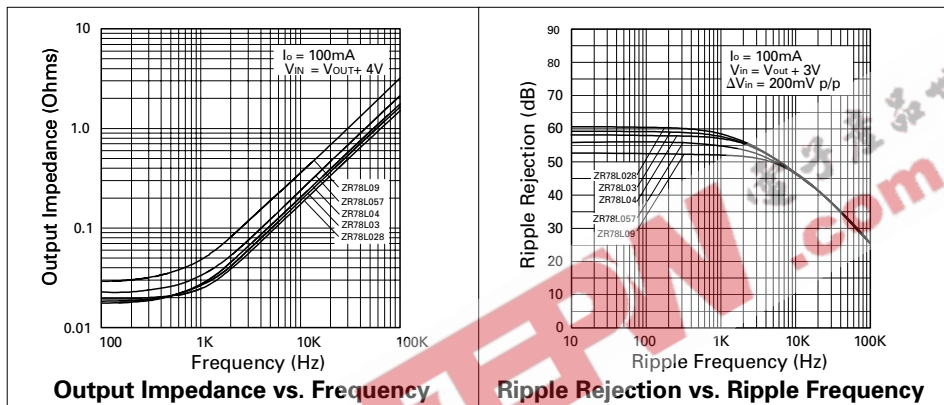

ZR78L SERIES

ZR78L033 ZR78L05
 ZR78L06 ZR78L08
 ZR78L10

TYPICAL CHARACTERISTICS

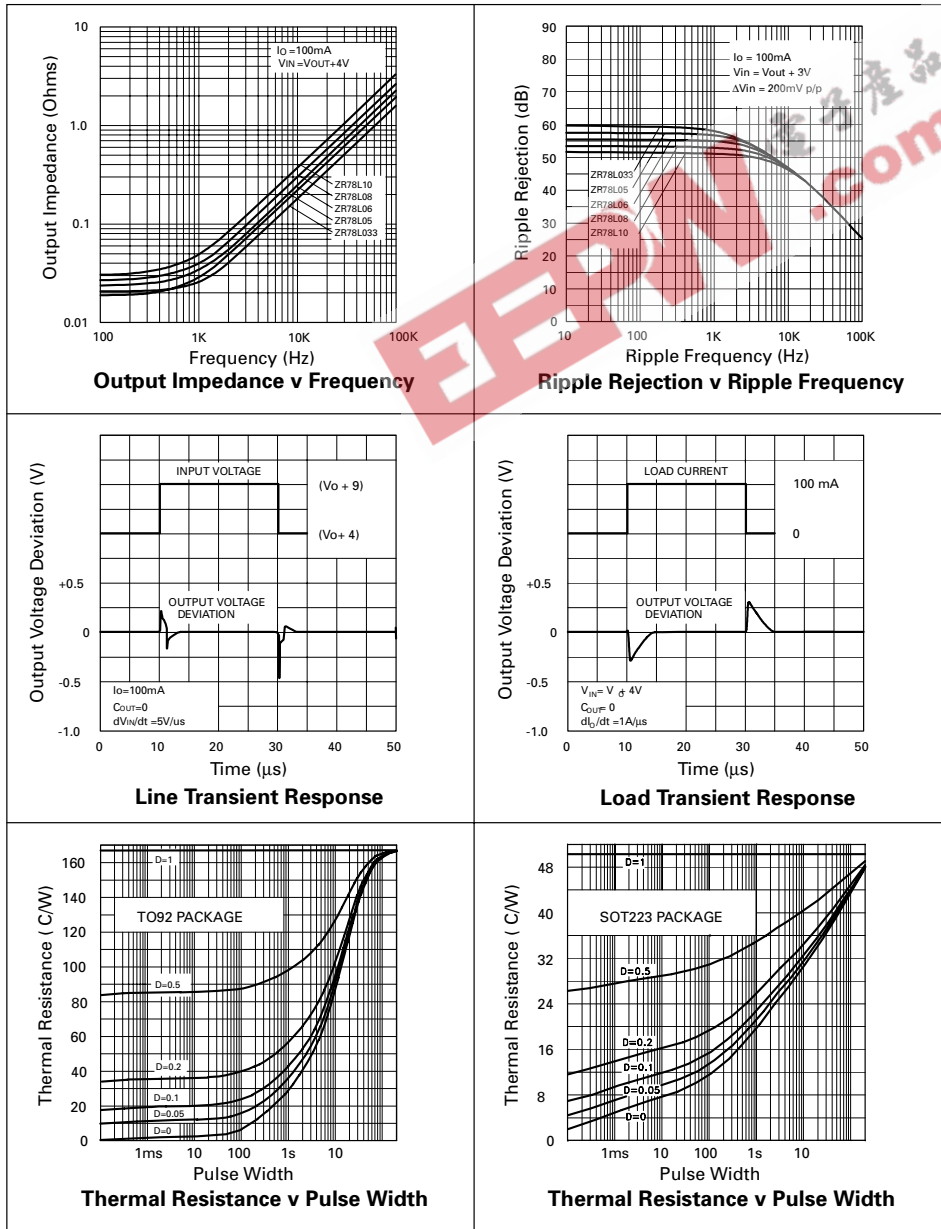

ZR78L SERIES

ZR78L07 TEST CONDITIONS (Unless otherwise stated): $T_j=25^{\circ}\text{C}$, $I_O=100\text{mA}$, $V_{in}=11\text{V}$

SYMBOL	PARAMETER	CONDITIONS	MIN.	TYP.	MAX.	UNITS
V_O	Output Voltage		6.825	7	7.175	V
		$I_O=1$ to 200mA τ	6.72		7.28	V
		$V_{in}=9$ to 20V $I_O=1$ to 100mA τ	6.72		7.28	V
ΔV_O	Line Regulation	$V_{in}=9$ to 20V		10	40	mV
ΔV_O	Load Regulation	$I_O=1$ to 200mA		5	25	mV
		$I_O=1$ to 100mA		2		mV
I_q	Quiescent Current	τ		350	600	μA
ΔI_q	Quiescent Current Change	$I_O=1$ to 200mA			100	μA
		$V_{in}=9$ to 20V			100	μA
V_n	Output Noise Voltage	$f=10\text{Hz}$ to 10kHz		75		$\mu\text{V rms}$
$\Delta V_{in}/\Delta V_O$	Ripple Rejection	$V_{in}=10$ to 18V $f=120\text{Hz}$	48	62		dB
V_{in}	Input Voltage Required To Maintain Regulation		9	8.7		V
$\Delta V_O/\Delta T$	Average Temperature Coefficient of V_O	$I_O=5.0\text{mA}$ τ		0.1		$\text{mV}/^{\circ}\text{C}$

ZR78L08 TEST CONDITIONS (Unless otherwise stated): $T_j=25^{\circ}\text{C}$, $I_O=100\text{mA}$, $V_{in}=12\text{V}$

SYMBOL	PARAMETER	CONDITIONS	MIN.	TYP.	MAX.	UNITS
V_O	Output Voltage		7.8	8	8.2	V
		$I_O=1$ to 200mA τ	7.68		8.32	V
		$V_{in}=10$ to 20V $I_O=1$ to 100mA τ	7.68		8.32	V
ΔV_O	Line Regulation	$V_{in}=10$ to 20V		11	40	mV
ΔV_O	Load Regulation	$I_O=1$ to 200mA		8	30	mV
		$I_O=1$ to 100mA		3		mV
I_q	Quiescent Current	τ		350	600	μA
ΔI_q	Quiescent Current Change	$I_O=1$ to 200mA			100	μA
		$V_{in}=10$ to 20V			100	μA
V_n	Output Noise Voltage	$f=10\text{Hz}$ to 10kHz		115		$\mu\text{V rms}$
$\Delta V_{in}/\Delta V_O$	Ripple Rejection	$V_{in}=11$ to 18V $f=120\text{Hz}$	44	60		dB
V_{in}	Input Voltage Required To Maintain Regulation		10	9.7		V
$\Delta V_O/\Delta T$	Average Temperature Coefficient of V_O	$I_O=5.0\text{mA}$ τ		0.25		$\text{mV}/^{\circ}\text{C}$

$\tau = T_j = -55$ to 125°C

ZR78L SERIES

ZR78L048 ZR78L052
ZR78L07 ZR78L085
ZR78L12

TYPICAL CHARACTERISTICS

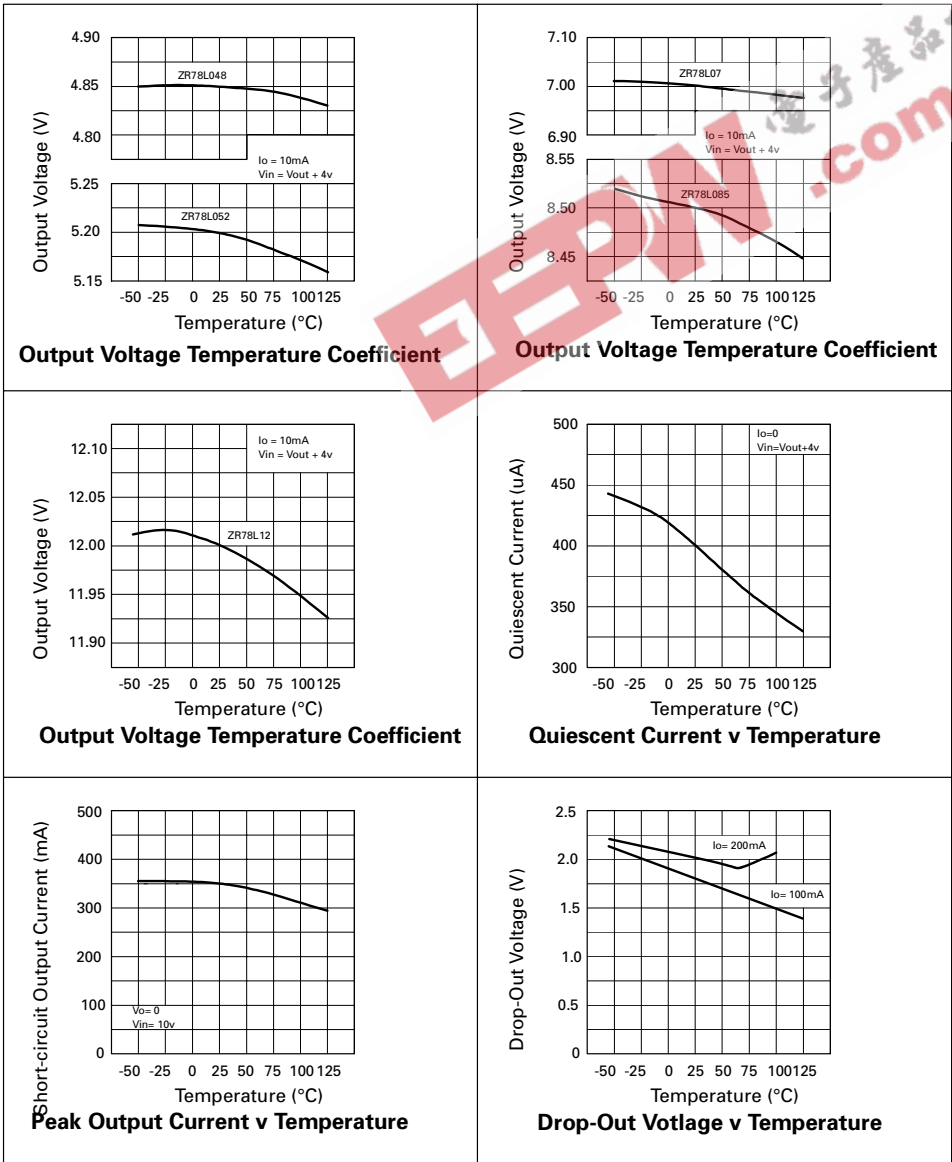

ZR78L SERIES

CONNECTION DIAGRAMS

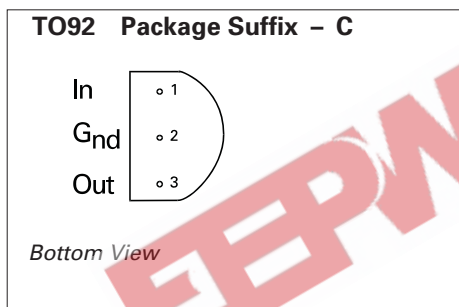
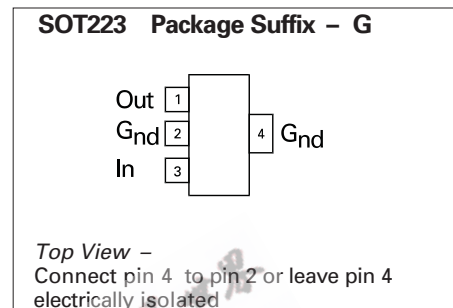
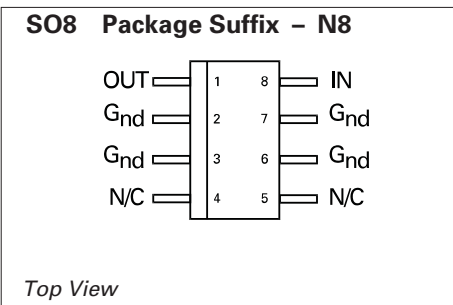

OPTIONS

Voltage	Voltage Options	TO92	SOT223	SO8
2.85V	028	✓	✓	
3.0V	03	✓	✓	
3.3V	033	✓	✓	✓
4.0V	04	✓	✓	
4.8V	048	✓	✓	
5.0V	05	✓	✓	✓
5.2V	052	✓	✓	
5.7V	057	✓	✓	
6.0V	06	✓	✓	
7.0V	07	✓	✓	
8.0V	08	✓	✓	
8.5V	085	✓	✓	
9.0V	09	✓	✓	
10.0V	10	✓	✓	
12.0V	12	✓	✓	

ORDERING INFORMATION

Part No	Package	Partmark
ZR78L s C	TO92	ZR78L s
ZR78L s G	SOT223	ZR78L s
ZR78L s N8	SO8	ZR78L s

s Voltage Option

eg 3V device in TO92 package
part number ZR78L03C
part marked ZR78L03

eg 12V device in SOT223 package
part number ZR78L12G
part marked ZR78L12

eg 5V device in SO8 package
part number ZR78L05N8
part marked ZR78L05

ZR78L048 ZR78L052
 ZR78L07 ZR78L085
 ZR78L12

ZR78L
 SERIES

TYPICAL CHARACTERISTICS

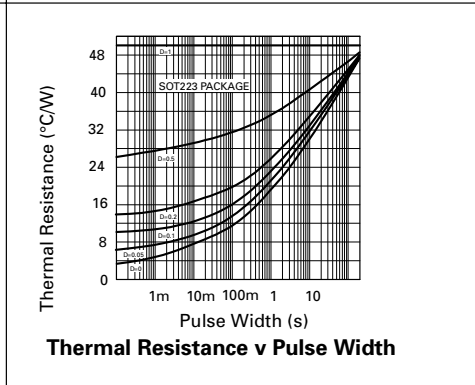
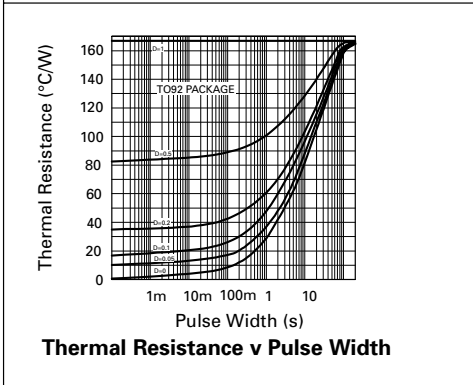
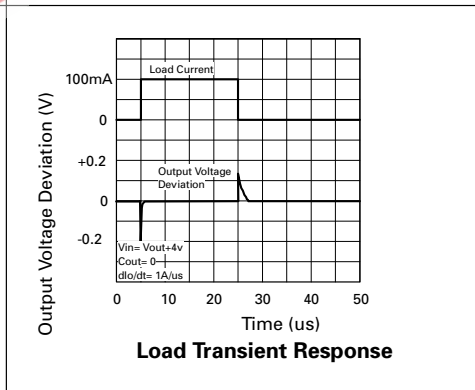
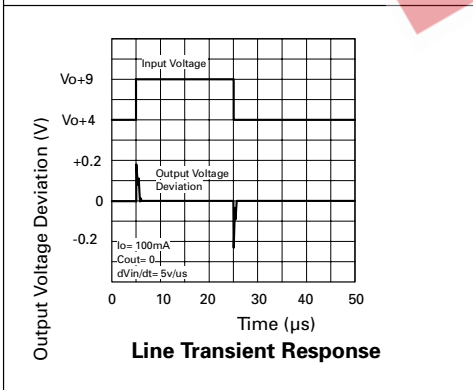
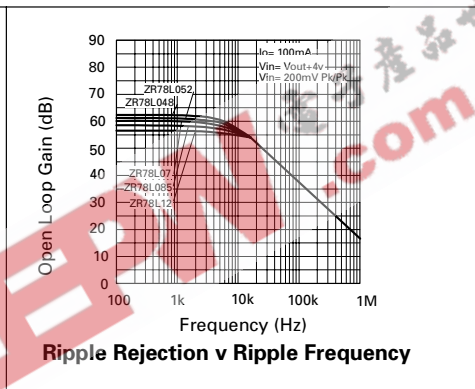
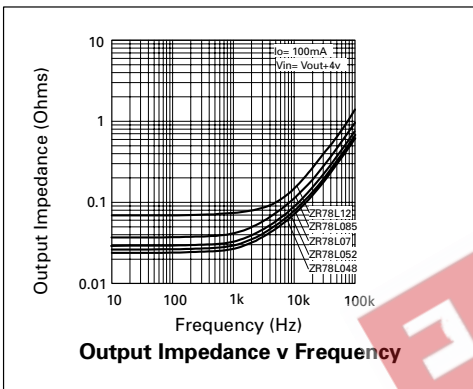

ZR78L SERIES

THERMAL CHARACTERISTICS

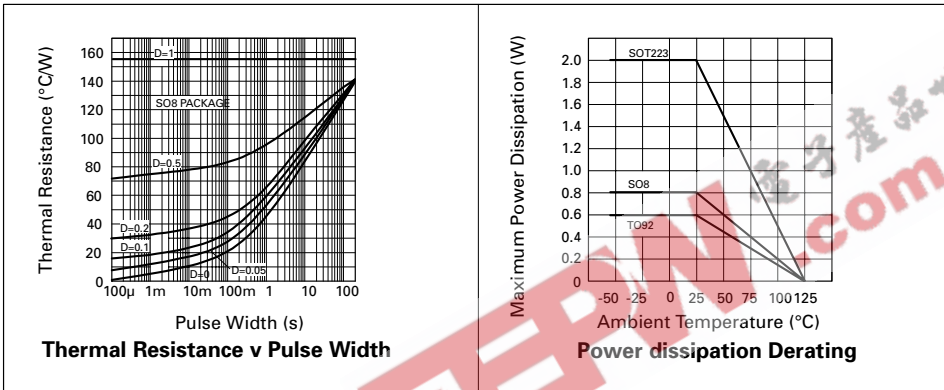

ZR78L SERIES

SCHEMATIC DIAGRAM

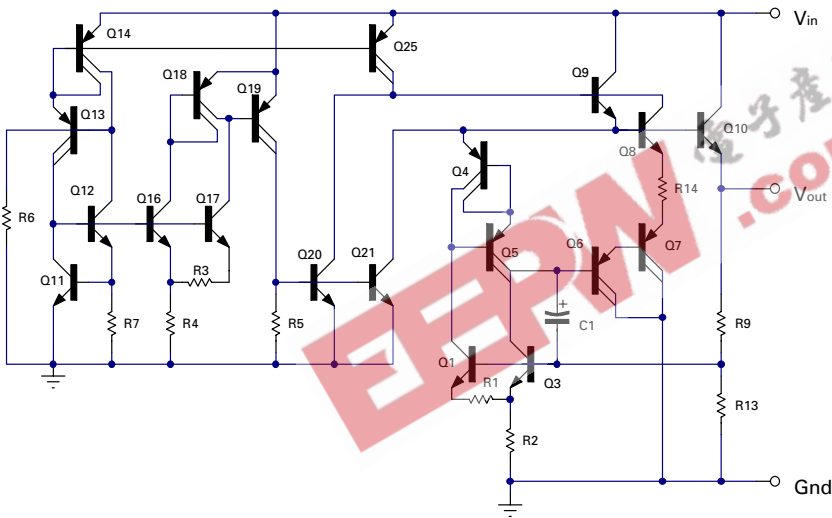

APPLICATIONS

Fixed Output Regulator

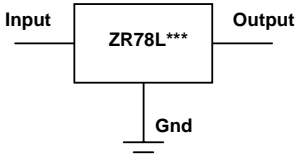

Adjustable Output Regulator

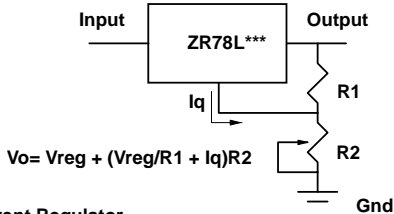

Current Regulator

